

SOLUTIONS FOR THE WATER AND WASTEWATER INDUSTRY

TAILOR-MADE TO YOUR APPLICATION



BAUER™ GEARED MOTORS

IN THE WASTEWATER INDUSTRY

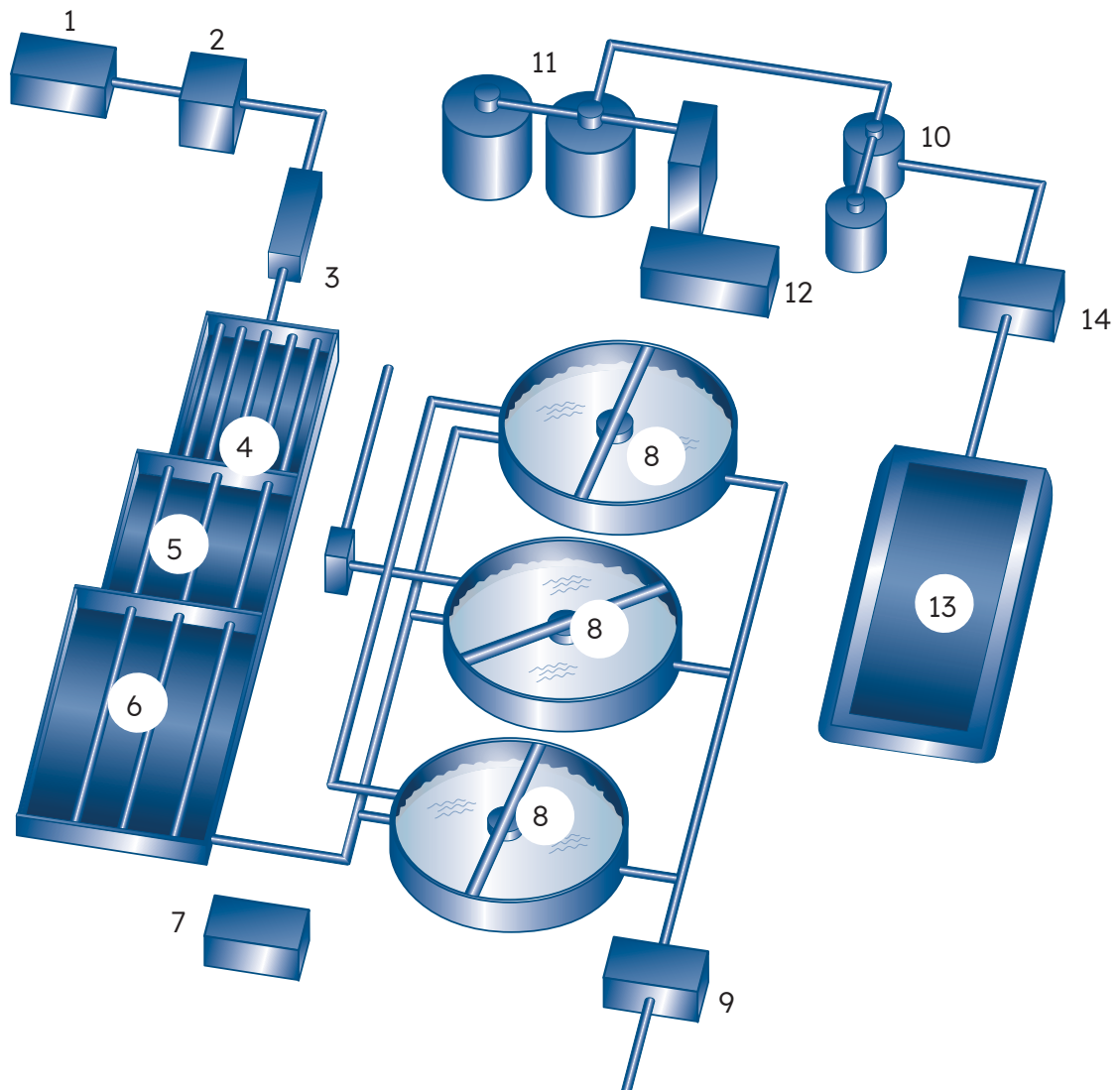

Schematic example of a typical treatment plant

BAUER™ GEARED MOTORS

CAN BE USED IN MANY DIFFERENT APPLICATIONS

1 INTAKE PUMPING STATION

2 RAKES

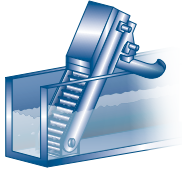

- » Bevel gear and parallel-shaft gear motors with hollow shaft and motor rating of **0.75 kW – 11 kW**
- » Special corrosion resistance class **C2**
- » ATEX 

3 SAND TREATMENT

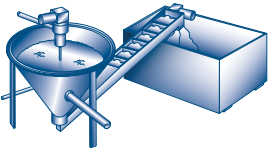

- » Parallel-shaft gear motors with hollow shaft and motor ratings of **0.55 kW – 1.5 kW**
- » Special corrosion resistance class **C2**.
- » ATEX 

4 PRIMARY SEDIMENTATION BASIN

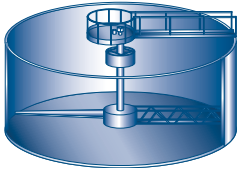

- » Parallel-shaft gear motors with hollow shaft and motor ratings of **0.12 kW – 2.2 kW**
- » Special corrosion resistance classes **C2 & 3**
- » Suitable for continuous operation

5 + 6 AERATION TANKS

- » Helical gear motor with motor rating of **1.5 kW – 45 kW**
- » Special corrosion resistance class **IM2**
- » For continuous and submersible operation (**IP68**)

7 BLOWER STATION

- » Rotary blowers/air compressors driven by standard motors with a wide performance range

8 FINAL SEDIMENTATION BASIN

9 PUMPS/SCREW WATER PUMPS

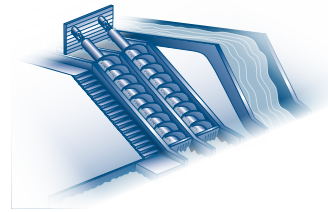

- » Parallel-shaft gear motors with hollow or solid shaft and motor ratings of **2.2 kW – 45 kW**
- » Suitable for continuous operation
- » Special flange available

10 SLUDGE THICKENING/TREATMENT

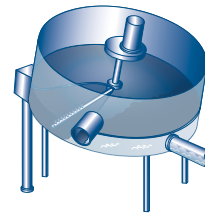

- » Parallel-shaft gear motors with motor ratings of **0.55 kW – 1.5 kW**
- » Special corrosion resistance class **C2**
- » Suitable for use with inverters

11 SEPTIC TANKS/AGITATORS

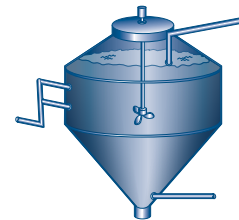

- » Bevel gear and parallel-shaft gear motors with agitator flanges and motor ratings of **0.55 kW – approx. 30 kW**
- » Special corrosion resistance class **C2**
- » Special “radial/axial load” flange available

12 BLOCK HEATING STATIONS

13 SLUDGE COLLECTION CONTAINER

14 SLUDGE DEWATERING/THICKENING

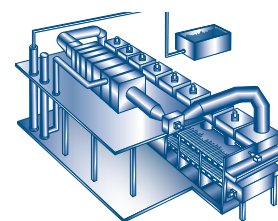

- » Bevel gear and parallel-shaft gear motors with motor ratings of **0.55 kW – 2.2 kW**
- » Special corrosion resistance class **C2**
- » Suitable for use under high ambient temperatures **up to 80°C**

YOUR BENEFIT IS OUR APPLICATION EXPERIENCE

RAKES

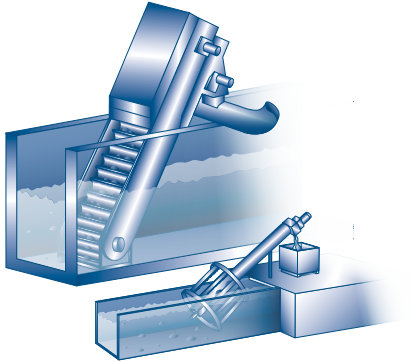

- Space saving by building the geared motor directly onto the machine.
- Thanks to the shaft-mounted gear motor, the radial/axial bearing and the shaft fixing on the rake are taken over by the gear.
- With an industrial geared motor there is no need for a tandem solution for large rakes with heavy loads, resulting in cost savings.
- By using Bauer premium efficiency motors with PMSM* technology, you can achieve up to 30% energy savings even with the typical intermittent operation of the rake.
- PMSM motors with efficiency classes up to IE5 are also available for ATEX protection zone 1 under frequency inverter operation.

WASH PRESS

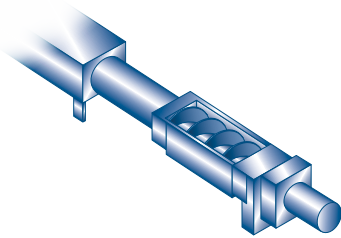

- Thanks to the reinforced bearings in the gears, the worm shaft can be incorporated directly into the gearing. As such, the customer needs one less bearing in the system.
- A special sealing design prevents foreign bodies penetrating into the gears during the washing process, which in turn reduces the maintenance frequency, increases the lifetime and guarantees process safety.
- PMSM motors with efficiency classes up to IE5 are also available for ATEX protection zone 1 under frequency inverter operation.

SAND TREATMENT

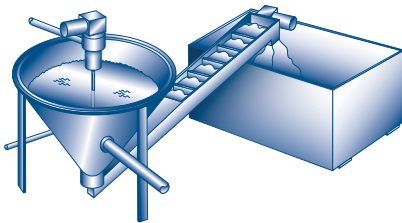

- Bauer geared motors with reinforced bearings increase lifetime and can absorb the high radial forces from the agitator shaft.
- From a gear size of 60 upwards, the gears can be fitted with agitator flanges, in order to be able to absorb very high radial/axial loads.
- Using the PMSM technology, high initial torque and high efficiency are achieved across the entire range of applications, so reducing the operating costs by up to 30%.

SEDIMENTATION TANKS

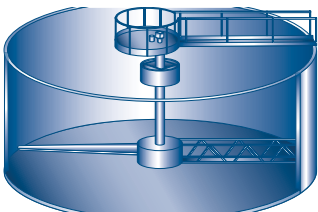

- A special paint delivers maximum corrosion protection and UV-stability for continuous operation in outdoor tanks (even close to the sea).
- Bauer geared motors with IP65 or IP66/67 protection as standard guarantee the highest reliability even in extreme environmental conditions.
- Bauer geared motors are designed for continuous operation and have exceptionally long service intervals (up to 25,000 hours), resulting in reduced maintenance costs.

* **PMSM** = **P**ermanent **M**agnet **S**ynchronous **M**otor

YOUR BENEFIT IS OUR APPLICATION EXPERIENCE

PUMPS/SCREW WATER PUMPS

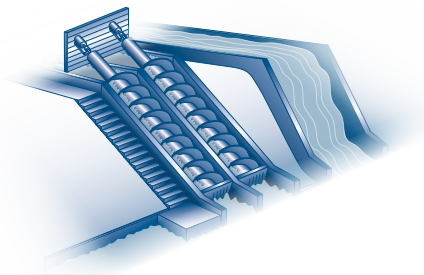

- Most pumps/screw water pumps run continuously with partial loads, so that by using Bauer premium efficiency motors with PMSM technology you can achieve huge energy savings of up to 40% and short amortisation periods.
- Designed for continuous operation, Bauer geared motors guarantee high reliability, with long service intervals that reduce operating and maintenance costs.
- Using Bauer premium efficiency geared motors, the investment costs for geared motors up to IE5 working with frequency inverters are significantly lower in the ATEX zone 1 area, compared to flame-proof motors.

SEPTIC TANKS/AGITATORS

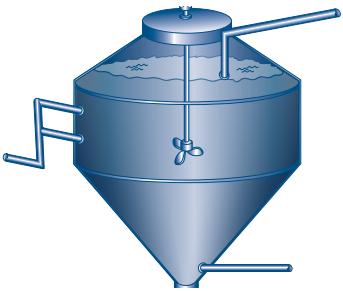

- Bauer geared motors are designed for continuous operation and have exceptionally long service intervals (up to 25,000 hours), resulting in reduced maintenance costs.
- Bauer Gear Motor also supplies planetary gear motors for very high torques, low speeds and small installation spaces.
- From a gear size of 60 upwards, the gears can be fitted with special agitator flanges that absorb the high radial/axial loads that are produced.
- Using the PMSM technology, high initial torque and high efficiency are achieved across the entire application range with small gear sizes and low power levels, reducing operating costs.

SLUDGE DEWATERING/THICKENING

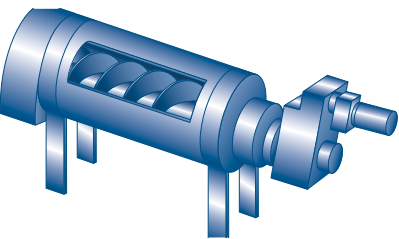

- Different rotation speeds and load ranges can be run synchronously with maximum torque and top efficiency thanks to the PMSM technology, resulting in a reduction in the number of variants possible.
- Very high initial torque can be handled by PMSM motors without a need for oversized motors, leading in turn to a reduction in weight and in the necessary power supply.
- Geared motors for the water screw pumps can be equipped with axial bearings, meaning that additional bearings on the machine are not required.

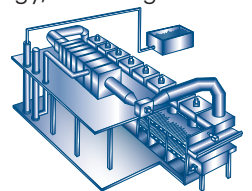

SOLAR DRYING

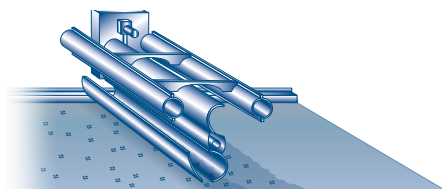

- Geared motors available for ambient temperatures up to +80°C and continuous operation.
- Bauer geared motors can also be used in ATEX Zone 1, and are approved for high ambient temperatures up to 60°C.
- Bauer-PMSM motors save energy across all working areas thanks to their high efficiency levels up to IE5.
- Bauer PMSM motors used in combination with an intelligent frequency converter make it possible to move loads with great precision and achieve accurate positioning without an encoder. By removing the encoder/initiators, the purchasing costs fall, and system errors and EMC interference are minimised.

CUSTOM SOLUTIONS

TAILORED TO SUIT YOUR APPLICATION

Agitators/mixers	
	<p>Function: To speed up the growth of the micro-organisms that devour the suspended solids it is necessary to introduce more air into the liquid, in order to optimise and speed up the process of cleaning the water.</p> <p>Demands on the drive:</p> <ul style="list-style-type: none"> • Suitable for continuous operation • Designed for very high radial load • Completely enclosed gears • Protection thanks to special gasket and coating <p>Solution: Parallel-shaft gear motor, e.g. BF80 in IP65</p> <p>Benefits:</p> <ul style="list-style-type: none"> • Special construction with larger bearing clearance (with long agitators high bending moments occur, this helps to support these) • Total gear motor in IP65 as standard, with "extremely high corrosion protection" as an option • Drives also available for various ATEX and Nema explosion areas
Underwater aerator IP 68	
	<p>Function: By means of continuous mixing/swirling of the medium, oxygen is added to help bacterial growth.</p> <p>Demands on the drive:</p> <ul style="list-style-type: none"> • Continuous operation • High energy savings • Designed for permanent submersible operation • High reliability • Simple maintenance <p>Solution: Helical gear motor, e.g. BG70 with special sealing flange incl. leakage sensor</p> <p>Benefits:</p> <ul style="list-style-type: none"> • Completely enclosed and sealed gears • Special sealing design with mechanical seal • Optoelectronic leakage detection on the medium side and gear side (water/oil) • Special single cable solution (power supply/monitoring and sensors all on one cable) • Power cable easy to replace • Special IP68 plug for fast changing of cables
Screenings wash press	
	<p>Function: The collected screenings are washed with high-pressure fresh water jets and then dewatered and pressed using a screw</p> <p>Demands on the drive:</p> <ul style="list-style-type: none"> • High radial/axial loads accepted without the need for additional customer-side flanges/bearings • Special sealing design in the flange to deal with high pressure from screenings • ATEX Zone 1 <p>Solution: Parallel-shaft gear e.g. BF60 with special flange</p> <p>Benefits:</p> <ul style="list-style-type: none"> • All bearings are within the gear motor (flange) (axial + radial forces) • Special seal design integrated in gear flange • Special seal (high pressure and high dirt content) • Thanks to building the gear flange to suit specific customer needs, the costs were reduced, as the customer did not need to add additional seals /bearings.

STANDARD GEARED MOTORS

HELICAL-GEARED MOTORS



BG SERIES

Compact and economical inline helical geared motors for long lifetime under arduous conditions.

- Motor power from 0.03 kW to 75 kW
- 13 gearbox sizes for torques from 20 Nm to 18500 Nm
- New attachment possibilities with low design height
- High efficiency through 2 stage base design
- High enclosure IP65 as standard

PARALLEL SHAFT GEARED MOTORS



BF SERIES

Shaft-mounted geared motors with integrated torque arm are easily integrated and economically applied.

- Motor power from 0.03 kW to 75 kW
- 10 gearbox sizes for torques from 90 Nm to 18500 Nm
- Gearbox housing with integral torque arm
- High efficiency through 2 stage base design
- High enclosure IP65 as standard

BEVEL-GEARED MOTORS



BK SERIES

Power-dense, right-angle, bevel-g geared motors ensure the highest efficiency especially when used with frequency inverters.

- Motor power from 0.03 kW to 75 kW
- 10 gearbox sizes for torques from 80 Nm to 18500 Nm
- Right angle gearbox with universal attachment possibilities
- High efficiency through 2 stage base design
- High enclosure IP65 as standard

WORM-GEARED MOTORS



BS SERIES

Economical, right-angle, worm-g geared motors install easily in the tightest applications.

- Motor power from 0.03 kW to 5.5 kW
- 8 gearbox sizes for torques from 25 Nm to 1000 Nm
- Hollow shaft version already available from 25 Nm
- High loadable worm gearing for long lifetime
- High enclosure IP65 as standard

PMSM IN IE5 FOR EX AREAS

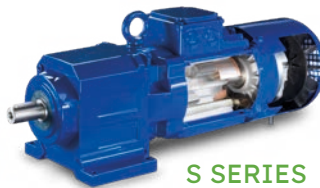

S SERIES

Permanent magnet synchronous motors (PMSM) Series S as variable speed motors in efficiency class IE5 for use in explosion hazardous areas.

- Design torque MN: 5 Nm – 48 Nm
- Rated power PN: 0.75 kW – 15 kW
- Protection type:
 - Increased Safety Zone 1
 - Ex II 2 G Ex e IIC T1 -T3 Gb
 - Dust explosion protection Zone 21
 - Ex II 2 D Ex tb IIIC T 160°C ... 120° Db

DECENTRALISED INVERTER GEARED MOTOR SERIES



Decentralised inverter solutions are an integrated combination of geared motors and frequency inverter, offering extremely compact decentralised drive solutions.

- Saving space and costs
- No shielded motor cables required
- Mechatronic adaption of inverter and geared motor
- Motor power range 0.12 kW up to 75 kW
- Supply voltage 3 x 380 V - 480 V
- Compliance to all EMC standards
- CANopen, AS-i, PROFIBUS, EtherCAT, PROFINET, EtherNet IP Comm. Int.
- STO (Safe Torque Off) and SIL 3 (Safety Integrity Level) safety functions
- UL approved

TOP QUALITY

FOR A LONG LIFETIME

MAIN FEATURES

- Special paints protect against aggressive brines, alkalis and salts, as well as aggressive environmental conditions
- High standard enclosure IP65
- Optionally the following protection levels are available:
 - IP66, IP67, IP68
 - rain cover for fan cowls
 - cast terminal boxes
 - cable design
 - non-ventilated motors
 - stainless steel nameplate
 - galvanised fan cowls
 - special seals
 - IP66 brake

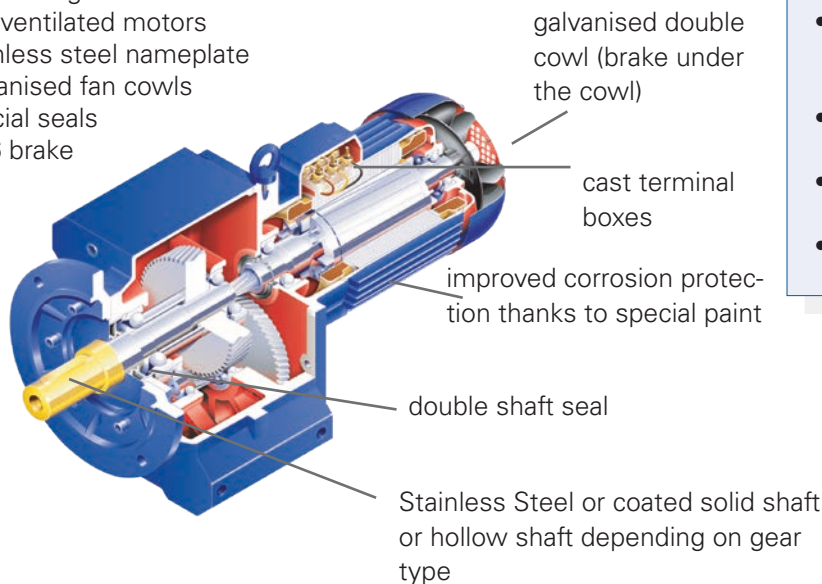

Standard Cage Clamp® terminals



with the following benefits:

- fast and secure connection of wires
- major time-saving, well-organised connection space, clear labelling of terminals
- total resistance to vibrations and shaking
- no risk of poorly attached cables or over-tightened screw connectors
- suitable for ex-protection

Terminal board available as an option



FLEXIBLE MOTOR MOUNTING

Geared motor as integrated version

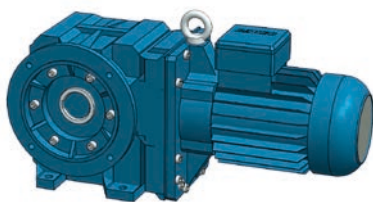

Bauer standard

- Good value solution, as the motor is integrated with the gearbox
- Short length
- Low weight
- ATEX
- IP68 possible

Geared motor with C/IEC flange

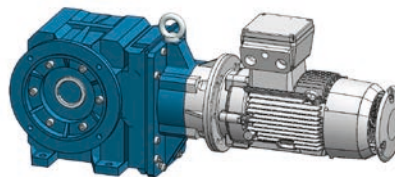

Bauer gears with C/IEC flange

- Bauer IEC motors can be built on
- Simple dry replacement of motor
- ATEX
- Any motors can be added on

Geared motor with C/Nema flange

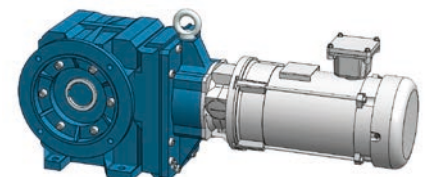

Bauer gears with C/Nema flange

- Nema standard
- Nema ex-protection (Class I: Division I)
- US motors can be built on (e.g. WEG, Baldor)
- UL/CSA compliant
- Backstop available
- IP68 possible

INDUSTRIAL GEARS FOR HIGH TORQUES



Planetary gears up to approx. 300 kN are possible, if high torques are required at low rotation speeds and low weight. These are often used in sludge presses, agitators, etc.



MOTOR TECHNOLOGIES IE1 • IE2 • IE3 • IE4 • IE5

IE-Class \ kW	0.12	0.18	0.25	0.37	0.55	0.75	1.1	1.5	2.2	3	4	5.5	7.5	9.5	11	15	18.5	22	30	37	
IE1 Asynchronous	●	●	●	●	●	●	●	●	●	●	●	●	●	●	●	●	●	●	●	●	●
IE2 Asynchronous	●	●	●	●	●	●	●	●	●	●	●	●	●	●	●	●	●	●	●	●	●
IE3 Asynchronous	●	●	●	●	●	●	●	●	●	●	●	●	●	●	●	●	●	●	●	●	●
IE4 Asynchronous					●	●	●	●	●	●	●	●	●	●	●	●	●	●	●	●	●
IE3 PMSM						●	●			●	●		●								
IE4 PMSM	●		●	●		●	●	●	●	●	●	●	●		●						
IE5 PMSM		●	●	●	●	●		●	●		●	●	●	●	●	●					

● = in planning

Benefits of permanent magnet technology

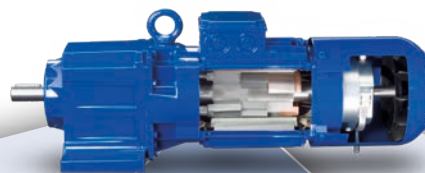

ALUMINIUM

Reference Losses 100%

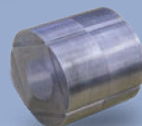

PERMANENT MAGNET

No voltage induction in the rotor

- No heat losses in the rotor
- Rotor losses reduced by 100%
- Total losses reduced by approximately 25%
- Total efficiency increased by more than 10%
- Partial load efficiency increased by more than 30%
- Synchronous speed
- High starting torque



COPPER

Higher electrical conductivity

- Rotor resistance reduces by 40%
- Heat losses in rotor reduced by 40%
- Total losses reduced by 10...15%
- Total efficiency increased by 1...2%

EtaK2.0

FLEXIBLE DUE TO MODULAR DESIGN

The EtaK2.0 features maximum user-friendliness in operation and installation. Especially for decentralised drive solutions, it demonstrates its high efficiency in terms of space, time and energy.

- Integrated safety technology and field bus communication according to individual requirements
- VFC eco mode offers an intelligent adjustment of the magnetising current
- Energy savings of up to 30% possible in partial load range
- Asynchronous motors and PM synchronous motors can be operated
- Suited to the harshest environments thanks to the high enclosure IP65
- Direct current braking
- Overload current
 - 200% (3 s)
 - 150% (60 s)



Drive Unit



Power unit - few variants

- Power unit with 3 designs available with 10 power ratings
 - BF1: Voltage: 380 - 500 V (3ph)
Power: 0.37 to 1.5 kW
 - BF2: Voltage: 380 - 500 V (3ph)
Power: 2.2 to 3.0 kW
 - BF3: Voltage: 380 - 500 V (3ph)
Power: 4.0 to 7.5 kW
- Enclosure IP65

Communication Unit



Functionality on site

- Communication via CANopen, PROFI-BUS, PROFINET, EtherCAT, EtherNET/IP and AS-interface
- Safety functions in accordance with EN 60204 (STO, SS1)
- Processing of I/O signals
- Without field bus: I/O via screw connections
- With field bus: bus and 2 input signals via M12
- Customised: up to max. 8 M12
- Pre-assembled M12 plugs available as accessories

Connection Unit

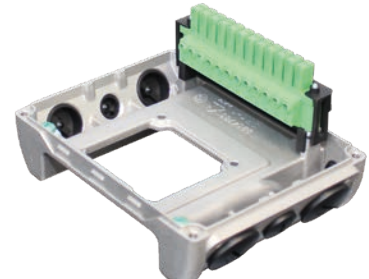

Flexible connection options

- Screwed cable gland and various plug connections
- Connection for braking resistor
- Spring-set brake control



PROPERLY PROTECTED

IN AGGRESSIVE ENVIRONMENTS

PAINT COATINGS OF A DRIVE WITH C5 SURFACE PROTECTION

C5 provides maximum corrosion protection for motors that are exposed to extreme environmental conditions and are used in aggressive environments or close to the sea.

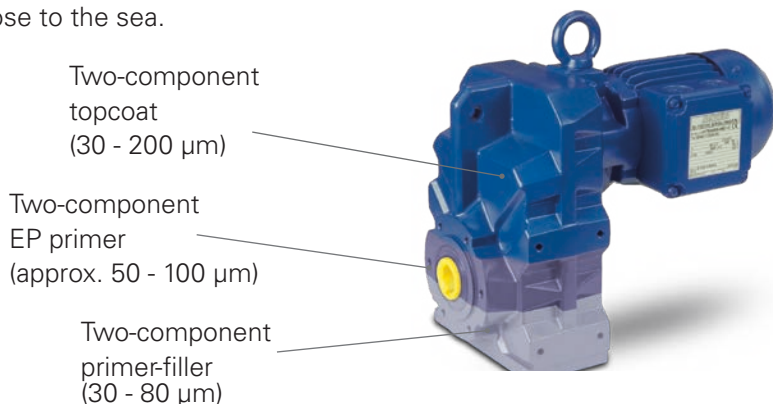

TYPES OF SEALS

Depending on the application, the correct type of sealing technology is selected in order to guarantee the best possible leakage protection.

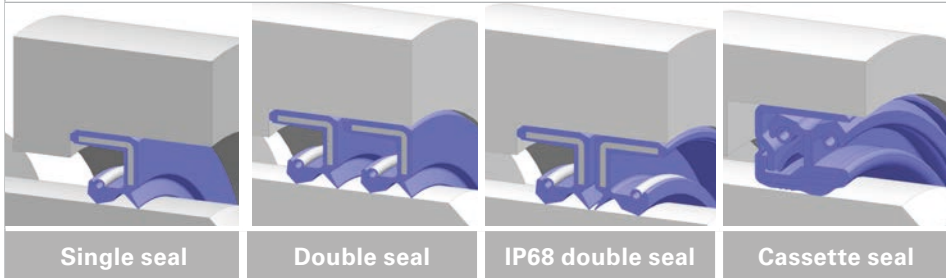

SYSTÈME DE PROTECTION DE LA PEINTURE SELON LA NORME DIN EN ISO 12944

Catégorie de corrosivité basé sur la norme DIN EN ISO12944-5	Standard	C1	C2	C3	C4	C5-I	C5-M	IM2
En intérieur avec une très faible pollution	++	++	+	+	+	+	+	+
En intérieur et extérieur avec une faible pollution	-	-	++	+	+	+	+	+
En intérieur et extérieur avec une pollution limitée	-	-	-	++	+	+	+	+
En intérieur et extérieur avec une forte pollution	-	-	-	-	++	+	+	+
En extérieur avec une pollution très élevée et dans des atmosphères agressives	-	-	-	-	-	++	+	+
Pour zones côtières et littorales à salinité importante	-	-	-	-	-	-	++	+
Usage subaquatique dans de l'eau de mer ou saumâtre	-	-	-	-	-	-	-	++

++ = parfaitement adapté + = adapté mais surdimensionné - = ne convient pas

IP65 ENCLOSURE - THE BAUER STANDARD

- All components are designed for IP65
- Designed for industrial environments
- Resistant to dust and water entry
- Non-corrosive name plate
- Space heater
- Moisture and drip protection insulation
- Pressure vent
- Shaft seal on motor side
- Galvanised fan cowl
- IP65 brake
- Special surface protection for the hollow shaft prevents fretting and other corrosion



Degrees of protection provided by enclosures (IP xx)

1. Code number	Protected against foreign objects
0	not protected
1	Protected against solid foreign bodies of 50 mm diameter and greater
2	Protected against solid foreign bodies of 12.5 mm diameter and greater
3	Protected against solid foreign bodies of 2.5 mm diameter and greater
4	Protected against solid foreign bodies of 1.0 mm diameter and greater
5	Dust-proof
6	Dust-tight
2. Code number	Protected against water
0	not protected
1	Protected against dripping water from above
2	Protected against dripping water from above - up to 15° slanted housing
3	Protected against spray water from above - up to 60° slanted housing
4	Protected against splash water - all directions
5	Protected against jets of water - all directions
6	Protected against strong jets of water under higher pressure
7	Protected against temporary immersion
8	Protected against prolonged submersion

IP68 GEAR MOTOR

FOR SUBMERSIBLE OPERATION

IP68 geared motors are most suitable where it is required to convey or transport foul, waste, river or rain water, and all types of sludge-containing waters in communal or industrial areas. They are frequently used in agitators for mixing, homogenising, etc. or in extremely wet areas or completely submerged under water.

- Special design for continuous submersible operation
- Gear housing and motor are completely waterproof
- Maximum leakage protection
- Special seals available for the output shaft
- Electronic leakage detection is available as an option for early recognition of errors
- Energy-saving asynchronous motors up to IE3 and permanent magnet motors up to IE5
- IP68 motors with brake available
- Gear motor can be operated at constant power in air or in a medium
- Fully cast cable to ensure maximum level of sealing
- Usable down to water depths of 5 m (greater depths also possible)
- Special coating allows extreme underwater conditions (coating resistant against many aggressive chemicals)
- Optionally also available with plug version of the cable
- Power classes: 0.37 – 11 kW (in Ex version on request)
- Use in potentially explosive atmospheres possible (e.g. Atex Zone 1)



IP68 ENCLOSURE

FOR GREATER SAFETY

FEATURES:

- **Shafts** can alternatively be made
 - of stainless **V4A steel**
 - or with special **surface coating**
- **Reinforced ball bearings** for higher strength or longer lifetime
- **Special sealing concepts** can be adapted depending on the environment (e.g. mechanical seals, cassette seals, etc.)
- **Brakes in IP68:** With **built-in spring-loaded brakes**, brakes are applied when the voltage is switched off
- The **direct current brake coil** is directly supplied with direct current or with alternating voltage via an external rectifier
- **Motor protection:**
For temperature protection, thermistors or thermostats can be integrated into the winding
- **Motor connection:**
The terminal box is cast with a special resin so that no moisture/liquids can penetrate into the motor. Errors due to poorly tightened terminal box covers are prevented.



Leakage detection:

Leakage can be detected early with an electronic sensor.

A special **plug connection** is available for up to 30 bar. This makes it easy to replace cables without disassembling the motor.

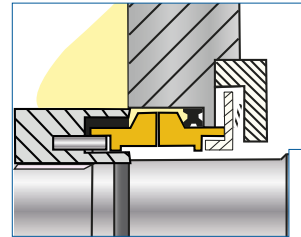
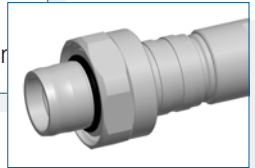

Mechanical seal:

Proven technology and high safety against leakage increase operational safety.

PAINT COATINGS OF A „IM2“ IP68 DRIVE

High-quality IM2 coating with a coating thickness of at least 450 µm guarantees maximum corrosion protection, high chemical resistance and tightness of the geared motors.

Two-component epoxy resin-anthracene oil combination (250 µm)

Output shaft available in stainless steel

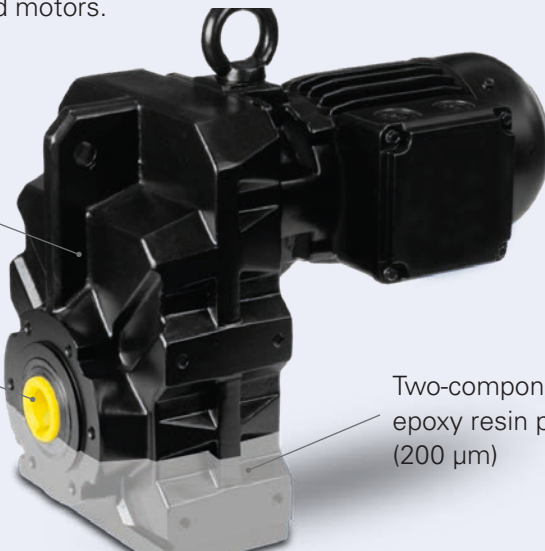

Two-component epoxy resin primer (200 µm)



BF SERIES

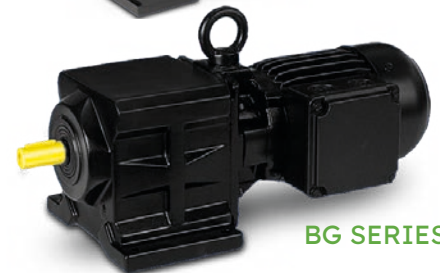

BG SERIES



BK/BS SERIES

MOTOR EFFICIENCY IN PRACTICE

In most applications, geared motors do not work at their nominal operating point. Although the motor nameplates indicate high efficiency levels at the nominal operating points, in reality these values fluctuate heavily because motors are mostly run at between 30 and 70% of the nominal load. Under precisely these working conditions there can be large fluctuations in the level of efficiency and therefore in the energy savings. With the Bauer premium efficiency motors, high efficiency levels can also be achieved in this load range and therefore the user can also make energy savings of over 30%.

The diagram below compares the different curves for the different motor technologies (ASM vs PMSM) at the same efficiency class IE3. It also shows a curve for an IE2 ASM motor for comparison purposes.

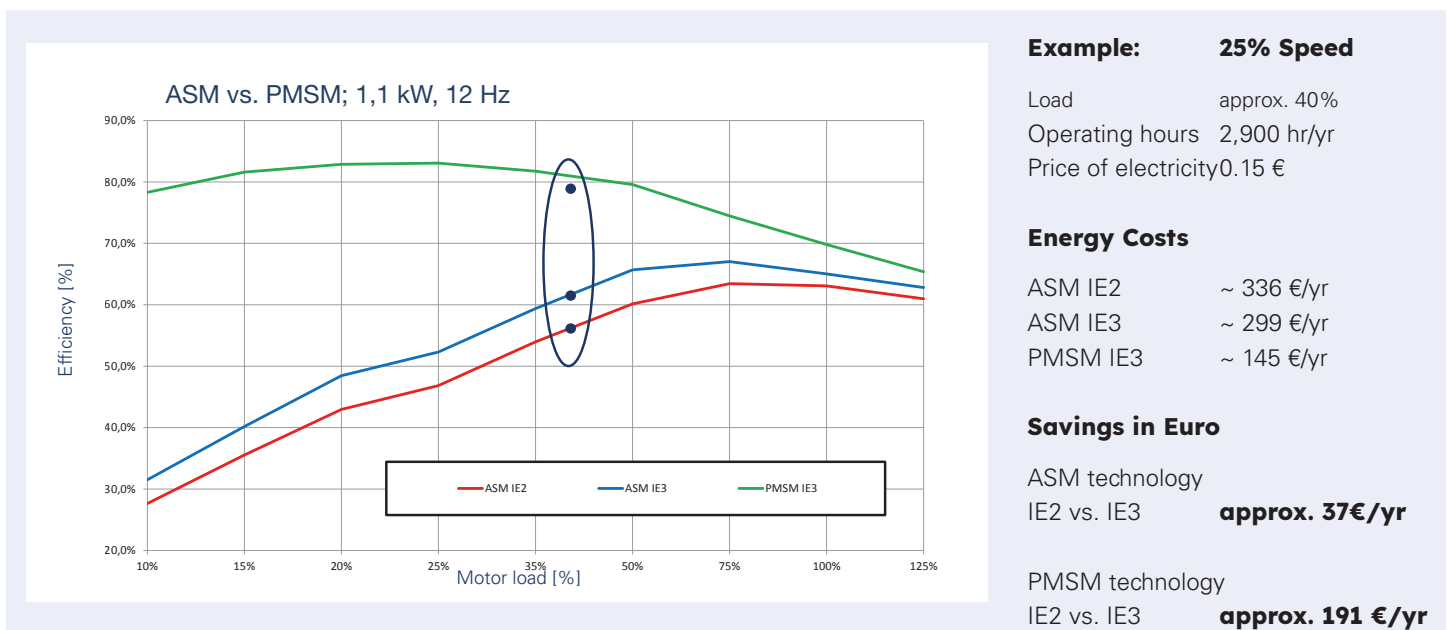
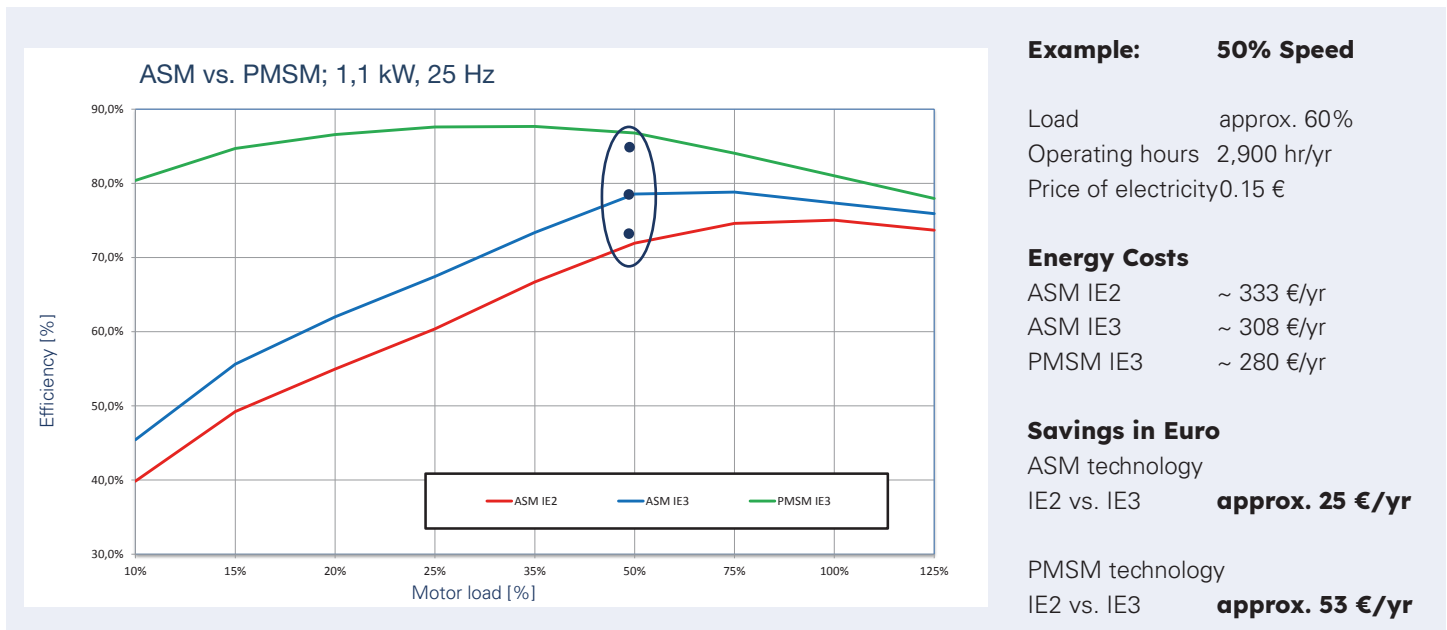

HISTOGRAM 3D EFFICIENCY LEVEL

ASYNCHRONOUS VS. PMSM

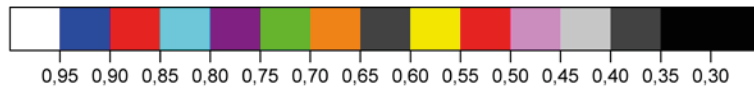
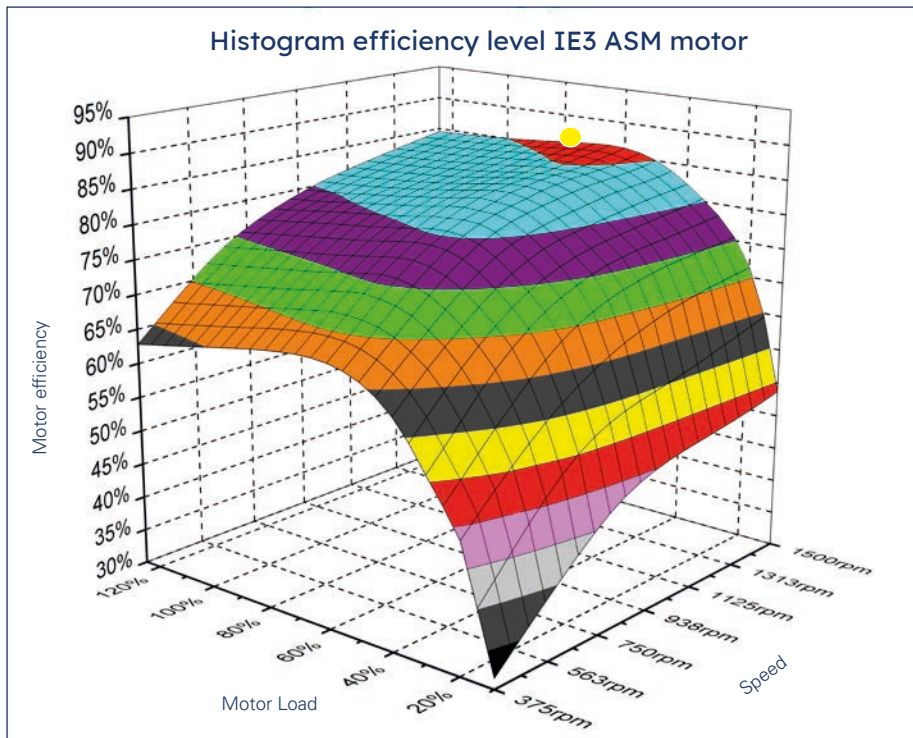

The IE3 asynchronous motor with 1.1 kW power in the diagram shown to the left has an efficiency of approx. 85% at the nominal point (shown in light blue - yellow dot). This high level of efficiency is only available in a very small operational range and drops quickly depending on the speed and load.

The lower the load on the motor or the speed of the motor, the lower the efficiency of the motor becomes.

Efficiency histograms make it possible to determine the actual level of efficiency for every operating point on the motor for the purposes of conducting a TCO calculation.

Operation with a partial load or a lower speed will not utilise all of the energy benefits of an IE3 ASM motor.

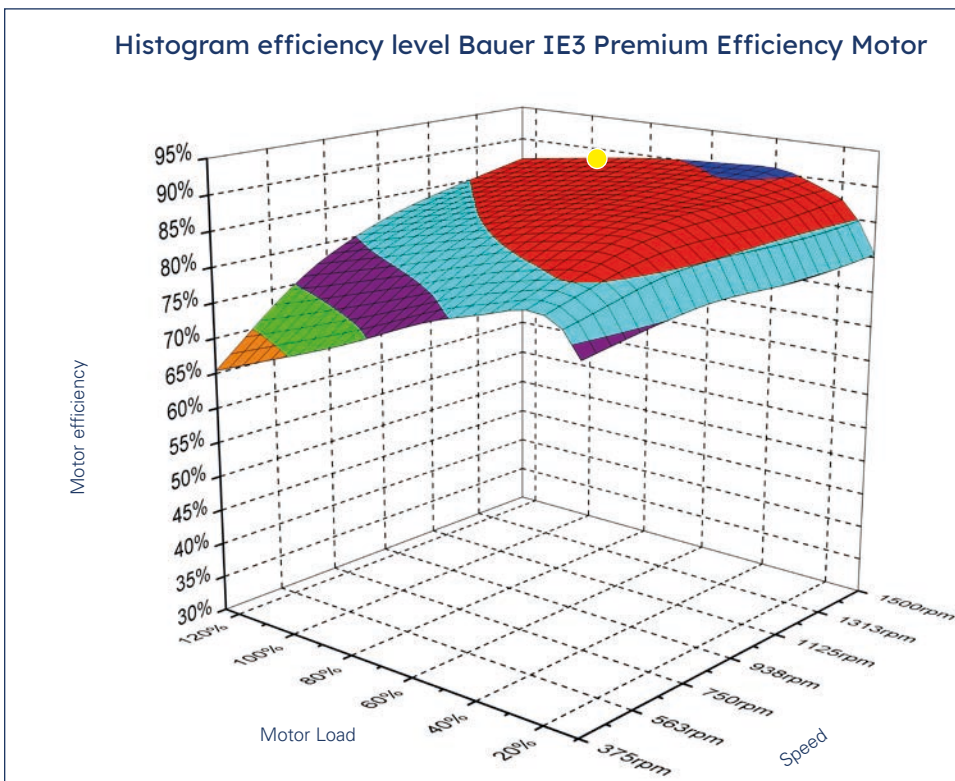

An IE3 Permanent Magnet Synchronous Motor (PMSM) with 1.1 kW power presents a much more even diagram than the IE3 ASM in the diagram above. The efficiency is approx. 88.4% at the nominal point (shown in dark red - yellow dot). When operated with a partial load, however, the efficiency increases to over 90% (shown in blue). The high level of efficiency (shown in dark red) generally covers a large area in such a way that high levels of efficiency are possible during partial load operation or at low speed. And the motor's extreme points, e.g. minimum load and minimum speed, have a clearly improved level of efficiency compared to the ASM.

The colours used in both diagrams represent the same level of efficiency. This makes it quick and easy to compare them.

You can clearly see for the PMSM motor that at almost every operational level of the motor there is a very high level of efficiency, and therefore it is very energy efficient.

EFFICIENCY COMPARISON

PUMPING SYSTEM



An increasing number of pumps are now being run using speed control in order to be able to define the dynamic volume flow. The pump's quadratic characteristic causes the motor load to decrease rapidly at lower speeds, which results in the level of efficiency decreasing significantly.

Using the diagrams, it can be seen that the ideal workload for the existing asynchronous motor is not reached, due to operation at partial loads (approx. 30%) and speeds (75%).

If the pump is then equipped with a PMSM motor that has an extended efficiency range including partial load operation, the level of efficiency can be increased by approx. 12% in this

previous solution	present solution using Bauer geared motors
4 kW motor	3 kW motor ✓
IEC motor 132	IEC motor 112 ✓
no IE class	IE3 ✓
Asynchronous motor	Bauer PMSM motor ✓

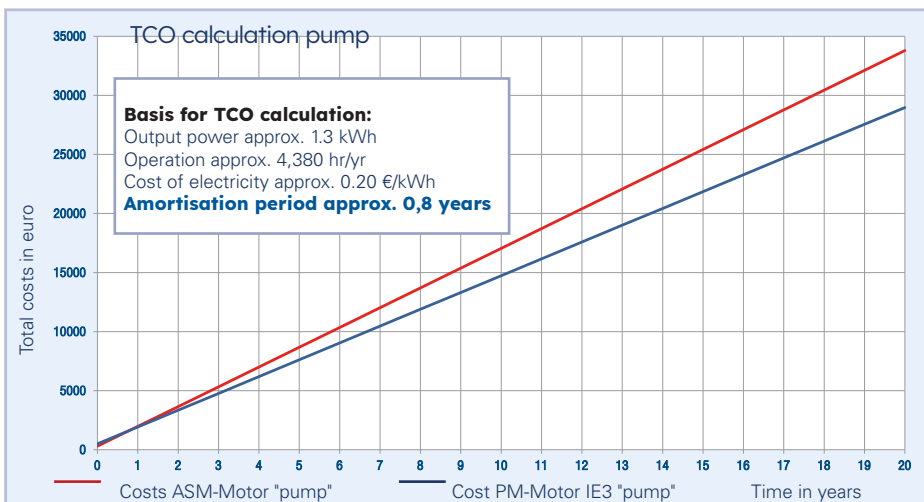
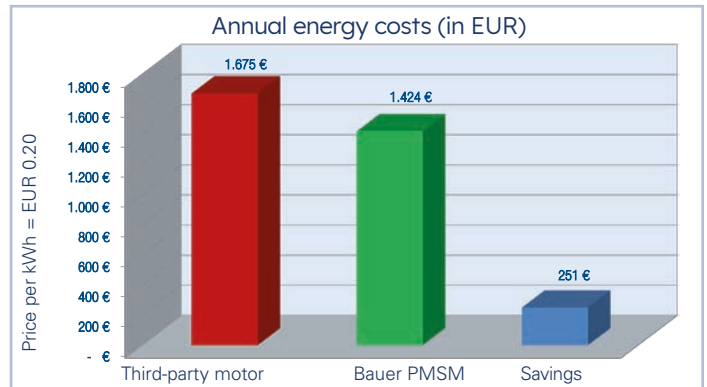
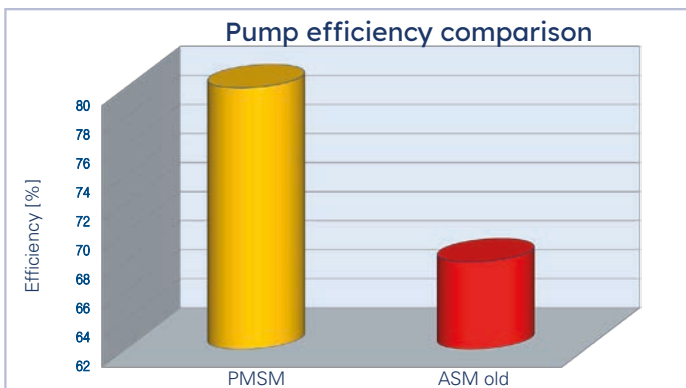

example and savings of more than EUR 250 per pump per year can be achieved (depending on the number of hours' operation per year).

The PMSM technology offers a major benefit above all for applications that run at partial load levels and variable speeds, allowing energy savings to be made. This means that the slight price increase for a new technology is amortised within just 10 months. And not only the efficiency is increased, also the gear size and weight can be reduced thanks to the higher performance density. Using the "synchronous operation" that it imposes, an exact flow level can be achieved e.g. with piston pumps.

EFFICIENCY COMPARISON

RAKES

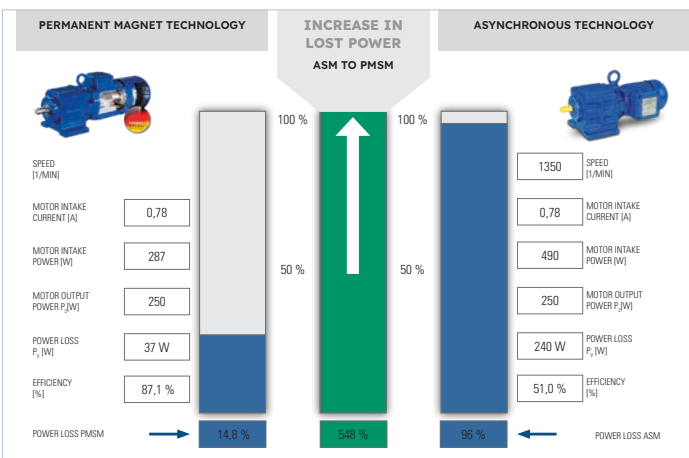

previous solution	present solution using Bauer geared motors
2.2 kW motor	2.2 kW motor ✓
IEC motor 90	IEC motor 80 ✓
IE2	IE3 ✓
Asynchronous motor	Bauer PMSM motor ✓
ATEX Zone 1	ATEX Zone 1 ✓

A presentation of the TCO and energy usage was also prepared for a rake, which runs all the time but in an intermittent pattern. PMSM motors also offer benefits for applications which are not running continuously.

Because this rake is running at about 10% load, the efficiency level of the motor falls off for this application. Even if there is no energy management due to the continual switching on and off S6-60%, by using a different motor technology “energy” can be saved. Using a cycle diagram you can see

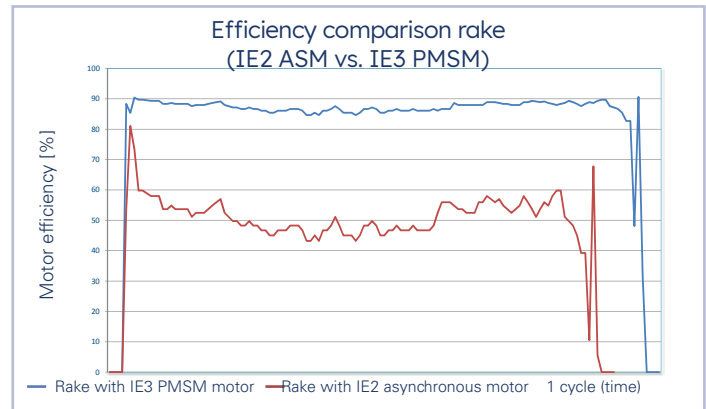

that on start-up, high torque is needed and therefore the motor needs to be oversized.

When the rake is running, the motor’s load uptake falls to approx. 10% of its rated power. Consequently, the efficiency of the ASM motor drops as a result of the low partial load. Using an ultra energy-efficient PMSM motor makes it possible to achieve close to the nominal efficiency even during operation with a partial load. As such, energy savings are guaranteed even with intermittent operation. This new motor technology is amortised within just 2 years.

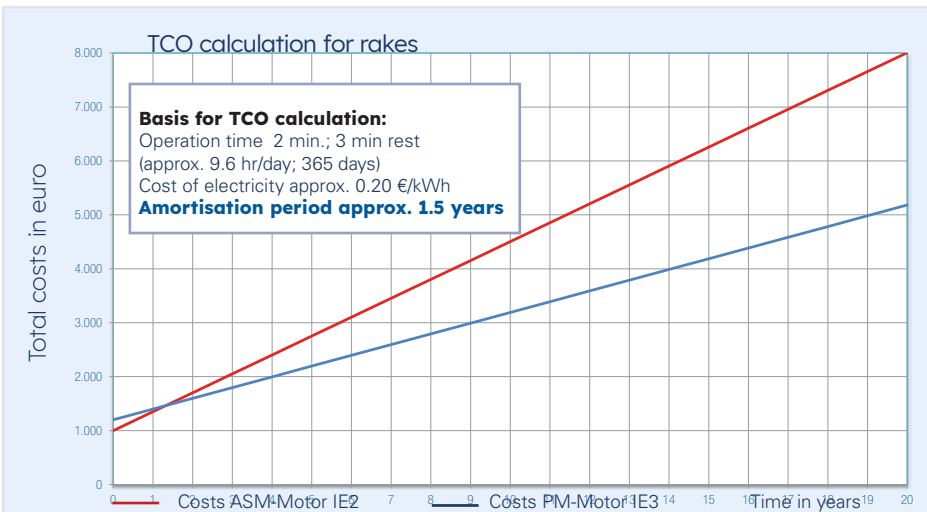

EFFICIENCY COMPARISON SLUDGE PRESS

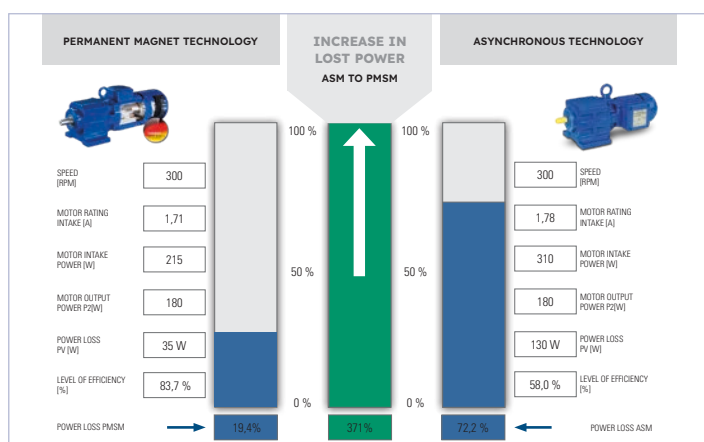

previous solution	present solution using Bauer geared motors
2.2 kW motor	2.2 kW motor <input checked="" type="checkbox"/>
IEC motor 90	IEC motor 80 <input checked="" type="checkbox"/>
IE2	IE3 <input checked="" type="checkbox"/>
Asynchronous motor	Bauer PMSM motor <input checked="" type="checkbox"/>

In a treatment plant, the energy consumption and motor efficiency of a sludge press were investigated. The measurements were taken and recorded while using an IE2 asynchronous motor and an IE3 PMSM motor. As a high speed and low torque is required in the rinsing cycle, and a low speed and high torque is required during press operation, a wide adjustment range must be available for the motor. As you can see from the diagrams, the machine in this example is operating at approx. 300 rpm (motor speed)

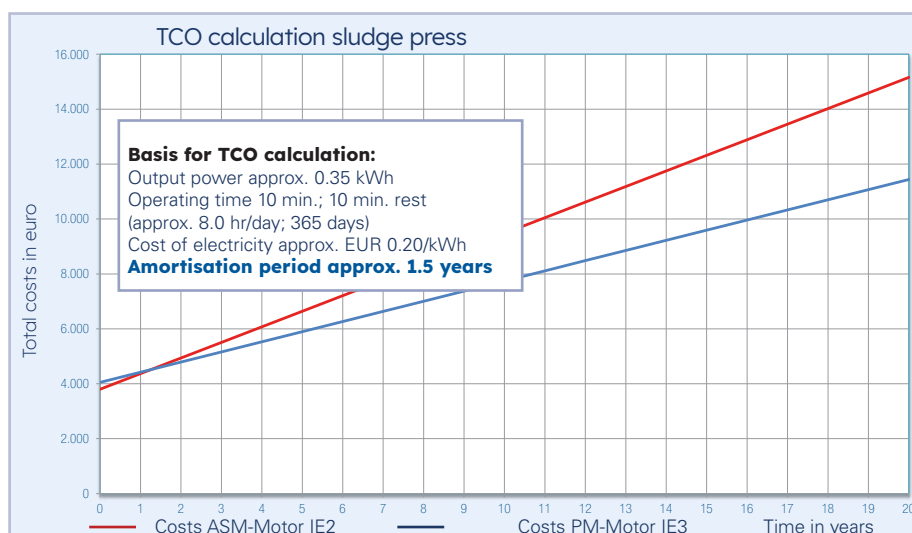
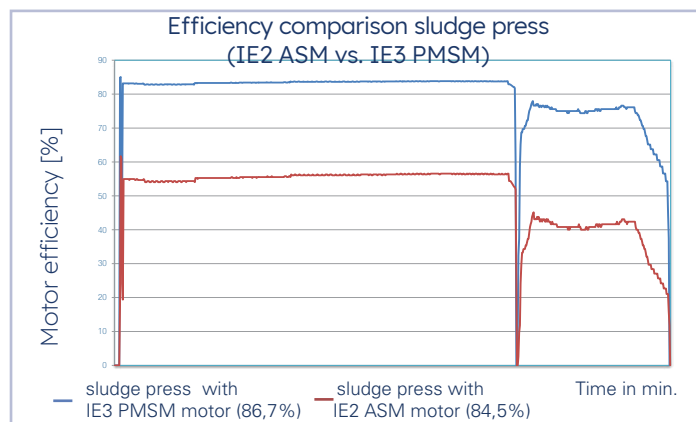

and approx. 10% load. The high starting torque (approx. 3.5 times higher) available from the motor is required briefly, usually when starting up or when carrying out compression. Under these extreme operating conditions, the efficiency of the asynchronous motor falls sharply. The PMSM motor really comes into its own, thanks to its extended efficient working range under partial loading, and delivers a short amortisation period of less than 2 years. Thanks to the motor's synchronous running, a stable speed can be used for the sludge presses at all levels of speed, as well as achieving very high start-up/initial torque using smaller motors.

ENERGY SAVING

AGITATOR



The original system, built in 1999, was composed of multiple 1.5 kW Direct On Line (DOL) asynchronous induction motors running at 50 Hz. The motors were supplied by Bauer Gear Motor (Type BF50-35A/D09LA4-TF-D) and had been running without any failures since their installation. However, as their energy efficiency couldn't reach the levels of the latest technology, it was decided to retire the existing system and specify a hi-tech alternative.

The initial request from the client was to replace the original motors with IE3 induction motors - this is what is typically seen as the standard 'energy efficient solution' in the water industry. However, as a result of Bauer's assessment of the facilities, it became evident that the wastewater treatment plant could further benefit from the specification of PMSMs running at the same frequency, 50 Hz.

The **IE3 PMSM technology** consumes less energy and requires lower power ratings for the same torque load than equivalent IE3 induction motors. When the system is running under partial load, the asynchronous motor has a drastically reduced efficiency level compared to PMSMs under the same conditions. According to measurements after the applications were fitted with the new motors, the replacement of induction motors with PMSM alternatives

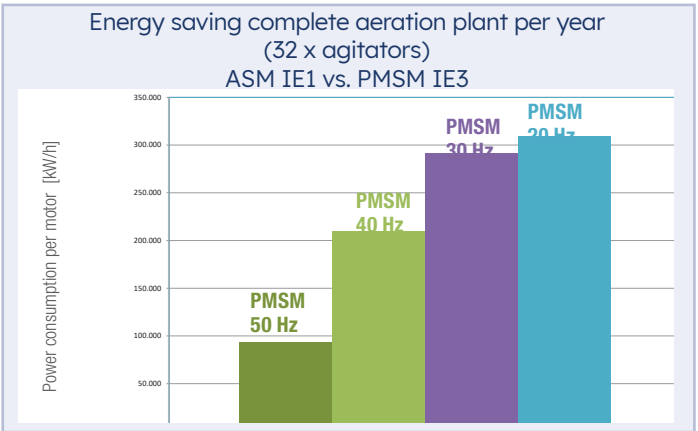

running at 50 Hz could save over **93,000 kW/h per year**. Assuming an energy price of € 0.20 kW/h, a reduction of 93,000 kW/h translates into over **€ 18,600 saved in one single year**.

An additional improvement was to use **an inverter duty motor** to reduce the line frequency without influencing the mixing behaviour. The result was, that for starting the mixing process the frequency of 50-60 Hz was required. After the wastewater was in motion and the sludge was suspended in the water, the speed could be reduced to 34 Hz, resulting in a **potential saving of over 260,000 kW/h** in energy consumption and **€ 52,000 in annual energy costs**.

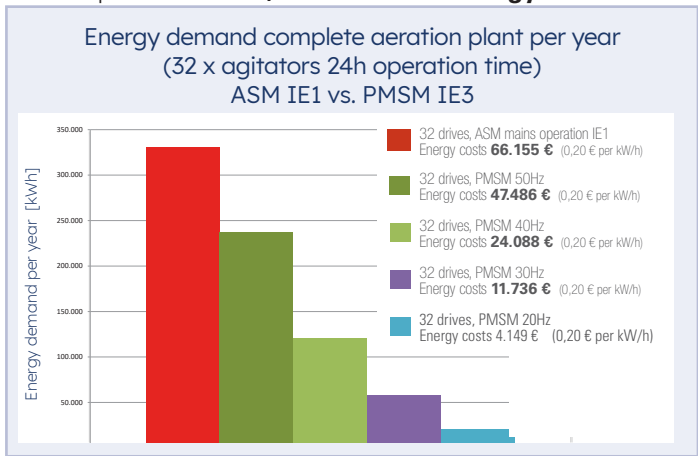
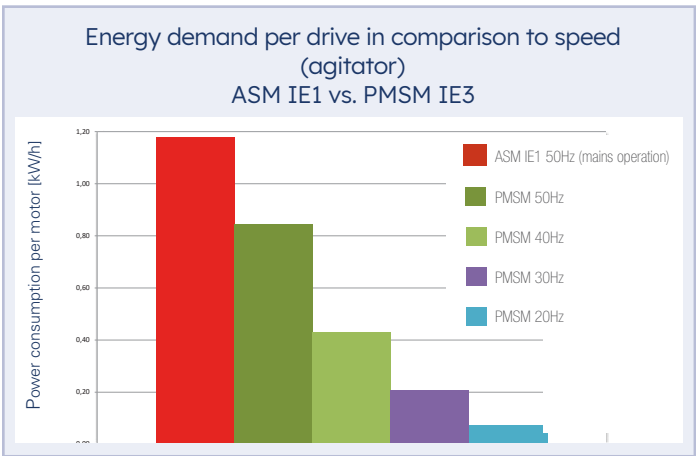



Regal Rexnord

[regalrexnord.com](https://www.regalrexnord.com) [bauergears.com](https://www.bauergears.com)

Germany

Eberhard-Bauer-Str. 37
73734 Esslingen - GERMANY
+49 711 3518 0

Slovakia

Továrenská 49
53 01 Zlaté Moravce - SLOVAKIA
+421 37 6926100

North America

701 Carrier Drive
Charlotte, NC 28216 - USA
+1 800-387-0130

China

18 Huanzhen Road,
Dabo Industry Zone, Shajing Town - Baoan District,
Shenzhen City, Guangdong Province - CHINA
+86 400 886 0365

The proper selection and application of products and components, including assuring that the product is safe for its intended use, are the responsibility of the customer. To view our Application Considerations, please visit <https://www.regalrexnord.com/Application-Considerations>.

To view our Standard Terms and Conditions of Sale, please visit <https://www.regalrexnord.com/Terms-and-Conditions-of-Sale>.

Images: Fotolia, Adobe Stock, Regal Rexnord and Bauer Archives, C.H. Schäfer Getriebe GmbH, Huber SE

"Regal Rexnord" is not indicative of legal entity. Refer to product purchase documentation for the applicable legal entity.

Regal Rexnord and Bauer Gear Motor are trademarks of Regal Rexnord Corporation or one of its affiliated companies.

© 2024 Regal Rexnord Corporation, All Rights Reserved.
MCB-P-7184-BGM-EN-A4 12/24

