













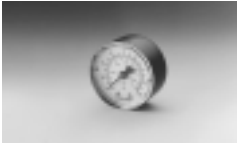

FLUID POWER



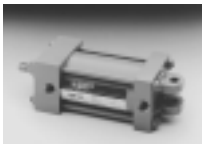

















**Air-Preparation,
Cylinders, Valves
Air Motors
and Accessories**

PRODUCT SELECTION / REFERENCE GUIDE

Air Preparation Products	Air Filters  Pages 5-7	Oil Removal Filters  Pages 8-9	Regulators  Pages 10-12
	Lubricators  Pages 13-15	Filter / Regulators (Piggy-Back)  Pages 16-18	Combination Assemblies  Pages 22-24
	Differential Pressure Indicator  Page 21	Pressure Gauges  Page 18	Relief Valves  Pages 19-20
	Drip Leg Drain  Page 20	Shut-Off Valves  Page 21	
Cylinders	E25 Series  Pages 26-40	BE10 Series  Pages 41-48	
	BE11/BJ11 Series  Pages 49-57	Cylinder Accessories  Pages 62-63	
Directional Control Valves	EK Series  Pages 65-83		

PRODUCT SELECTION / REFERENCE GUIDE

<p>Actuators (Rotary)</p>	<p>Air Motors</p>  <p>Pages 84-86</p>		
<p>Accessories</p>	<p>Quick Exhaust Valves</p>  <p>Page 87</p>	<p>Flow Control Valves</p>  <p>Page 88</p>	<p>Needle Valves</p>  <p>Page 88</p>
	<p>Check Valves</p>  <p>Page 88</p>	<p>Shut-Off Valves</p>  <p>Page 89</p>	<p>Shuttle Valves</p>  <p>Page 90</p>
	<p>Slide Valves</p>  <p>Page 90</p>	<p>Breather Vents</p>  <p>Page 91</p>	<p>Mufflers</p>  <p>Page 91</p>
	<p>Speed Control Mufflers</p>  <p>Page 91</p>	<p>Coalescing Muffler</p>  <p>Page 91</p>	<p>Exhaust Mufflers</p>  <p>Page 92</p>
	<p>Inline Filters</p>  <p>Page 92</p>	<p>Recoiling Nylon Hose</p>  <p>Page 93</p>	<p>Push-On Fittings</p>  <p>Page 94</p>
	<p>Blow Guns</p>  <p>Page 95</p>	<p>Quick Disconnect Fittings</p>  <p>Page 96</p>	

AIR PREPARATION PRODUCTS



Table of Contents

	Page
Air Filters	5-7
Oil Removal Filters	8-9
Regulators	10-12
Lubricators.....	13-15
Filter / Regulators (Piggyback)	16-18
Pressure Gauges	18
Relief Valves.....	19-20
Drip Leg Drain.....	20
Shut-Off Valves	21
Differential Pressure Indicator	21
Combination Assemblies	22-24

AIR FILTERS



Boston Gear's Air Filters are designed for general applications in compressed air systems where effective filtration and removal of solid water particles and impurities are required. Order filters with an automatic drain when the filter will be installed in an inaccessible area and when large quantities of water are present. Water vapor will pass through these filters and could condense into liquid form downstream as the air temperature drops. An air dryer would be required if water condensation could have a detrimental effect on the application.

FEATURES

- Removes liquid and solid contaminants to protect air tools and other equipment.
- Screw-on bowl reduces maintenance time.
- Cleanable depth type element has extra large surface area for long service life. The elements can be cleaned in soap and water.
- Choice of automatic or manual drains.
- Can be disassembled for cleaning without the use of tools or removal from air line (air pressure off).
- Available in four basic sizes.

Miniature Models

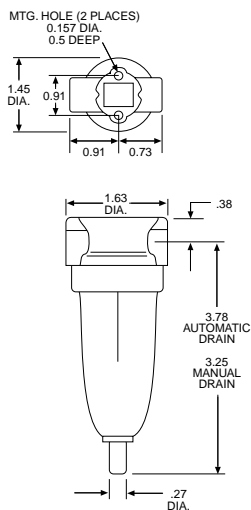

Specifications

Port Sizes – 1/8" and 1/4" NPT
 Maximum Operating Conditions
 Plastic Bowl – 150 PSIG, 125°F
 Metal Bowl – 250 PSIG, 175°F
 Filter Element
 Standard – 5 Micron
 Optional – 100 Micron
 Bowl
 Standard – 1/2 Oz. Plastic
 Optional – 1/2 Oz. Metal
 Drain – Manual or Automatic with 1/4" diameter tube connection

Materials

Body – Zinc
 Bowl –
 Plastic – Polycarbonate
 Metal – Zinc
 Filter Element – Porous Polypropylene
 Elastomers – Neoprene and Nitrile

MOUNTING BRACKET

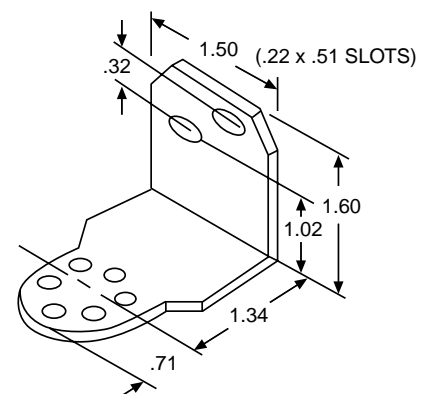

EN41108-BT

ORDER BY CATALOG NUMBER OR ITEM CODE

Port Size (NPT)	Approx. Flow* (SCFM)	Automatic Drain		Manual Drain	
		Catalog Number	Item Code	Catalog Number	Item Code
1/8	19	EN41111	74753	EN41110	74733
1/4	24	EN41121	74754	EN41120	74734

*Flow obtained at 100 PSIG inlet pressure and 5 PSID pressure drop using standard element.

AIR FILTERS

Compact Models

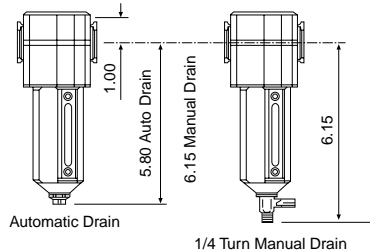
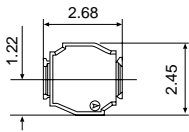

Specifications

Port Sizes – 1/4", 3/8" and 1/2" PTF
 Maximum Operating Conditions
 – 250 PSIG, 175°F
 Filter Element
 Standard – 40 Micron
 Optional – 5, 25 Micron
 Bowl – 1.9 Oz. Metal with Liquid Level
 Indicator Lens
 Drain – Manual – 7/16-24 UNS male thread
 Automatic – 1/8" PTF connection

Materials

Body – Aluminum
 Bowl – Aluminum
 Filter Element – Sintered Polypropylene
 Elastomers – Neoprene and Nitrile
 Liquid Level Indicator Lens – Transparent
 Nylon

ORDER BY CATALOG NUMBER OR ITEM CODE

Port Size (PTF)	Approx. Flow* (SCFM)	Automatic Drain		Manual Drain	
		Catalog Number	Item Code	Catalog Number	Item Code
1/4	62	EN71221-MG	39914	EN71220-MG	39915
3/8	75	EN71231-MG	39916	EN71230-MG	39917
1/2	80	EN71241-MG	39918	EN71240-MG	39919

*Flow obtained at 100 PSIG inlet pressure and 5 PSID pressure drop using standard element.

MOUNTING BRACKET

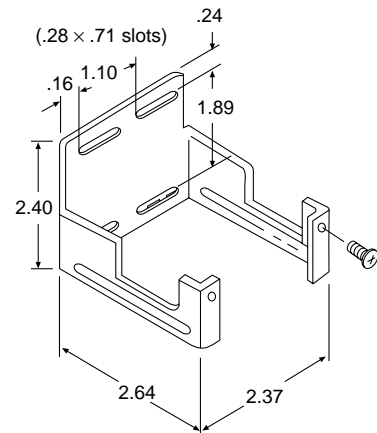

EN71208-B

ACCESSORIES / REPAIR PARTS, PAGE 7

Standard Models

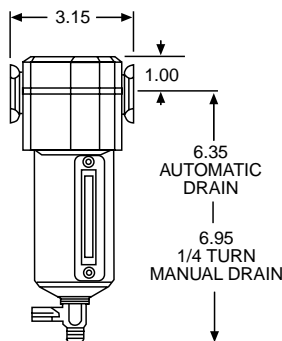
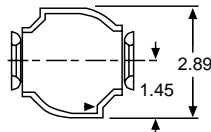

Specifications

Port Sizes – 3/8", 1/2" and 3/4" PTF
 Maximum Operating Conditions
 – 250 PSIG, 175°F
 Filter Element
 Standard – 40 Micron
 Optional – 5 and 75 Micron
 Bowl – 7 Oz. Metal with Liquid Level
 Indicator Lens
 Drain – Manual – 7/16-24 UNS male thread
 Automatic – 1/8" PTF connection

Materials

Body – Aluminum
 Bowl – Aluminum
 Filter Element – Sintered Polypropylene
 Elastomers – Neoprene and Nitrile
 Liquid Level Indicator Lens – Transparent
 Nylon

ORDER BY CATALOG NUMBER OR ITEM CODE

Port Size (PTF)	Approx. Flow* (SCFM)	Automatic Drain		Manual Drain	
		Catalog Number	Item Code	Catalog Number	Item Code
3/8	120	EN61331-MG	70683	EN61330-MG	70686
1/2	150	EN61341-MG	70684	EN61340-MG	70687
3/4	150	EN61351-MG	70685	EN61350-MG	70688

*Flow obtained at 100 PSIG inlet pressure and 5 PSID pressure drop using standard element.

MOUNTING BRACKET

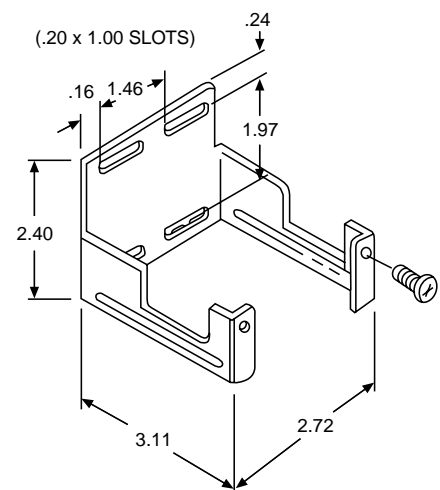

EN62308-B

ACCESSORIES / REPAIR PARTS, PAGE 7

AIR FILTERS

Jumbo Models

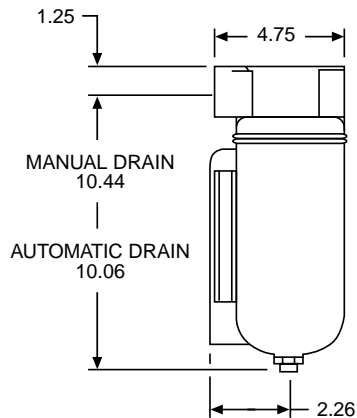

Specifications

Port Sizes – 3/4", 1", 1-1/4" and 1-1/2" PTF
 Maximum Operating Conditions
 – 250 PSIG, 175°F
 Filter Element
 Standard – 40 Micron
 Optional – 5 and 25 Micron
 Bowl – 1 Qt. metal with sight glass
 Drain – Manual or Automatic with 1/8" NPTF connection

Materials

Body – Aluminum
 Bowl – Aluminum with Pyrex Sight Glass
 Filter Element
 5, 25 and 50 Micron – Sintered Bronze
 75 Micron – Monel Screen
 Elastomers – Neoprene and Nitrile

MOUNTING BRACKET

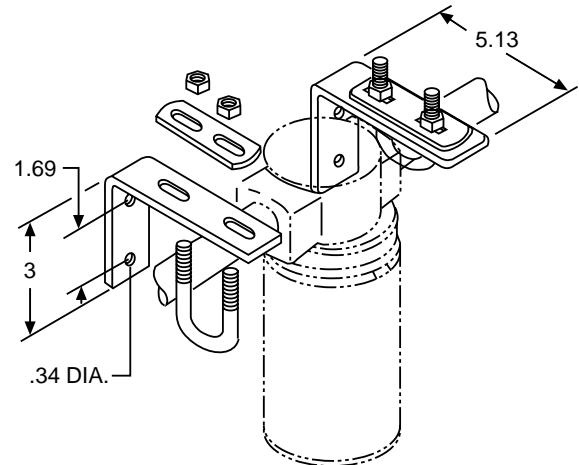

ORDER BY CATALOG NUMBER OR ITEM CODE

Port Size (PTF)	Approx. Flow* (SCFM)	Automatic Drain		Manual Drain	
		Catalog Number	Item Code	Catalog Number	Item Code
3/4	345	EN41451-MG	73941	EN41450-MG	73927
1	445	EN41461-MG	73947	EN41460-MG	73931
1-1/4	445	EN41471-MG	73949	EN41470-MG	73933
1-1/2	445	EN41481-MG	73955	EN41480-MG	73939

*Flow obtained at 100 PSIG inlet pressure and 5 PSID pressure drop using standard element.

ACCESSORIES / REPAIR PARTS, BELOW

EN41408-BA
 EN41408-BB

Air Filter — Accessories / Repair Parts

ORDER BY CATALOG NUMBER OR ITEM CODE

Description	Miniature		Compact		Standard		Jumbo	
	Catalog Number	Item Code	Catalog Number	Item Code	Catalog Number	Item Code	Catalog Number	Item Code
Service Kit (Seals)			EN71209	39836	EN61309	70669	EN41409	70719
Plastic Bowl								
Manual Drain	EN41109-PBT	74144	EN61209-PB	70324				
Automatic Drain	EN41109-PBAT	74787	EN61209-PBA	70325				
Metal Bowl								
Manual Drain	EN41109-MB	74142	EN71209-MG	39843	EN61309-MG	76811	EN41409-MG	74923
Automatic Drain	EN41109-MAT	74143	EN71209-MGA	39844	EN61309-MGA	71082	EN41409-MGA	—
Filter Element								
5 Micron	EN41109-5	74735	EN71209-5	39850	EN61309-5	70670	EN41409-5	74983
25 Micron			EN71209-25	39851			EN41409-25	71803
40 Micron			EN71209-40	39852	EN61309-40	70671		
50 Micron							EN41409-50	74751
75 Micron					EN61309-75	—	EN41409-75	—
100 Micron	EN41109-100	—						
Automatic Drain Kit			EN71001	39829	EN41001	74752	EN41001	74752
Manual Drain Kit			EN61009	71084	EN61009	71084	EN41009	71405
Mounting Bracket								
All	EN41108-BT	76824	EN71208-B	39846	EN62308-B	70677		
3/4 & 1" Ports							EN41408-BA	76825
1-1/4 & 1-1/2 Ports							EN41408-BB	76826
Connector †			EN61308-C	76812	EN61308-C	76812		
Connector with Mounting Feet †			EN61308-CB	76813	EN61308-CB	76813		
Mounting Feet †			EN61308-F	39833	EN61308-F	39833		

† See Page 22 for Dimensions

OIL REMOVAL FILTERS



Boston Gear's oil removal (coalescing) filters are used in compressed air systems to provide an extremely clean air supply virtually free of oil aerosols. Unwanted oil is often introduced into compressed air systems by the lubricating oil in the air compressor. Typical applications include paint spraying, pneumatic control instrumentation, printing and paper separation and protection of air bearings and fluidic instrumentation. Oil removal filters are supplied with an automatic drain and a service life indicator as standard features. The service life indicator provides visual indication of the condition of the filter element, eliminating the guesswork of when to replace the element. The indicator shows green when new and as the pressure differential across the element increases it will turn to red. To ensure that the filter element provides a long service life, it is recommended that a standard air filter with a 5 micron element is placed prior to the oil removal filter.

FEATURES

- High efficiency coalescing element removes particles down to 0.01 micron. Maximum revisioning oil content of air leaving the filter is 0.01 ppm at 70°F with an inlet concentration of 8 ppm.
- Service life indicator shows red as the pressure differential across the element increases. Red will be the predominant color when the differential pressure exceeds 10 PSID indicating the element should be replaced.
- Automatic drain to provide automatic purging of contaminants in bowl.
- Can be disassembled for cleaning without tools or removal from air line (air pressure off).
- Screw on bowl reduces maintenance time.
- Sight Glass (liquid level indicator) for visual indication of amount of liquid in bowl at all times.

Specifications

Port sizes—1/4", 3/8", 1/2", 3/4", 1", 1-1/2", and 2" PTF

Maximum Operating Conditions—
250 PSIG, 150°F

Bowl—Metal

Drain—Automatic with 1/8" PTF connection.

Materials

Unit	EN71621-MG EN71631-MG	EN61631A-MG EN61641-MG EN61641-JMG EN61651-JMG	EN41651-MG EN41661-MG	EN41681-MG EN41691-MG
Body	Aluminum	Aluminum	Aluminum	Aluminum
Bowl	1.9 Oz. Aluminum	7 Oz. Aluminum	1 Qt. Aluminum	1/2 Pt. Zinc
Sight Glass (Liquid Level Indicator)	Transparent Nylon	Transparent Nylon	Pyrex	Pyrex
Elements	Synthetic Fiber and Polyurethane Foam			
Elastomers	Nitrile and Neoprene			
Service Life Indicator	Acetal and Nylon	Acetal and Nylon	Aluminum and Polycarbonate	Aluminum and Polycarbonate

ORDER BY CATALOG NUMBER OR ITEM CODE

Port Size (PTF)	Oil Removal Filter				Recommended** Pre-Filter Catalog Number
	Flow* (SCFM)	Fig.	Catalog Number	Item Code	
1/4	21	A	EN71621-MG	39920	EN71221-5MG
3/8	21	A	EN71631-MG	39921	EN71231-5MG
	20	B	EN61631A-MG	70661	EN61331-5MG
1/2	35	B	EN61641-MG	70662	EN61341-5MG
	60	C	EN61641-JMG	70663	EN61341-5MG
3/4	60	C	EN61651-JMG	70664	EN61351-5MG
	90	D	EN41651-MG	74769	EN61351-5MG
1	125	D	EN41661-MG	73984	EN41461-5MG
1 1/2	250	E	EN41681-MG	74541	EN41481-5MG
2	300	E	EN41691-MG	74542	EN41591-25MG

*Approximate flow at 100 PSIG inlet pressure and 5 PSID pressure drop.

**Refer to air filter section for specifications.

OIL REMOVAL FILTERS

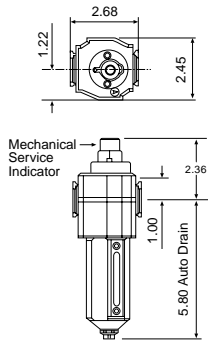

FIGURE A

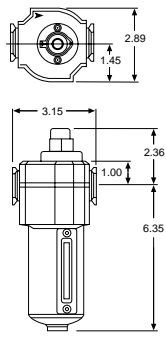

FIGURE B

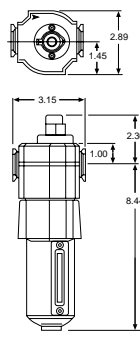

FIGURE C

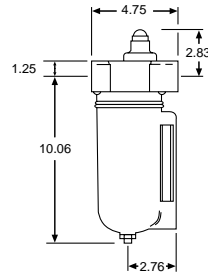

FIGURE D

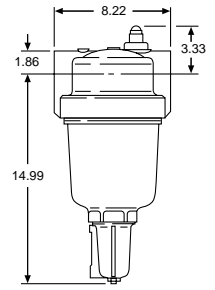

FIGURE E

Accessories/Repair Parts

ORDER BY CATALOG NUMBER OR ITEM CODE

Description	EN71621-MG EN71631-MG		EN61631A-MG EN61641-MG EN61641-JMG EN61651-JMG		EN41651-MG EN41661-MG		EN41681-MG EN41691-MG	
	Catalog Number	Item Code	Catalog Number	Item Code	Catalog Number	Item Code	Catalog Number	Item Code
Seal Kit	EN71609	39838	EN61639	70674	—	—	—	—
Metal Bowl (Manual Drain)	EN71209-MG	39843	EN61309-MG	76811	EN41409-MG	74923	EN41309-MG	74922
Metal Bowl (Automatic Drain)	EN71209-MGA	39844	EN61309-MGA	71082	—	—	—	—
Filler-Element*	EN71629	39853	EN61639-01 EN61639-02	70675(1) 70676(2)	EN41659	74825	EN41689	70668
Automatic Drain	EN71001	39829	EN41001	74752	EN41001	74752	EN41001	74752
Service Life Indicator	EN5797-50	70672	EN5797-50	70672	EN5796-50	74976	EN5796-50	74976
Mounting Bracket	EN71208-B	39846	EN61308-B	70677	EN41408-BA EN41408-BB	76825 (3) 76826 (4)	—	—

Notes:

*includes O-ring

(1) EN61631A-MG & EN61641-MG

(2) EN61641-JMG and EN61651-JMG

(3) EN41651-MG

(4) EN41661-MG

Mounting Brackets

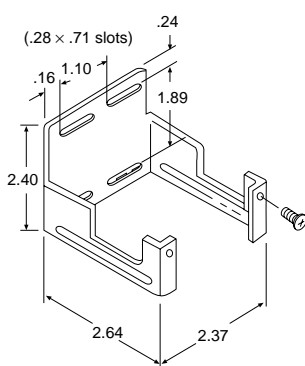

EN71208-B

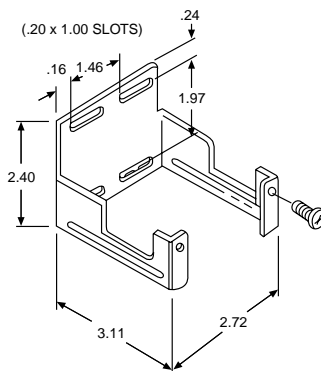

EN61308-B

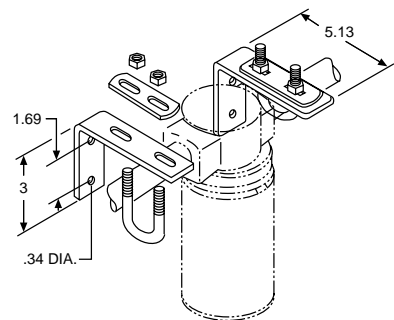

EN41408-BA EN41408-BB

REGULATORS



Boston Gear's pressure regulators are used in compressed air systems to reduce system pressure to a level which can be used to efficiently operate air tools and other air operated equipment. These regulators maintain the reduced pressure at a constant level despite the changes in the inlet pressure and changes in downstream flow requirements. All regulators are relieving which allow the outlet pressure to be reduced even though the system is dead-ended. Non-relieving models are available.

FEATURES

- Accurate and quick response to flow.
- Two full flow gauge ports.
- Balanced valve minimizes the effect of variations in inlet pressure on the outlet pressure.
- Low torque, non-rising pressure adjustment knob provides easy hand adjustment at any pressure. The knob has an integral locking device which can be made tamper resistant with the addition of an optional *Tamper Resistant Kit*.
- Panel or bracket mounting available.
- Can be easily disassembled for service without removal from air line (air pressure off).

Miniature Models

PANEL MOUNTING

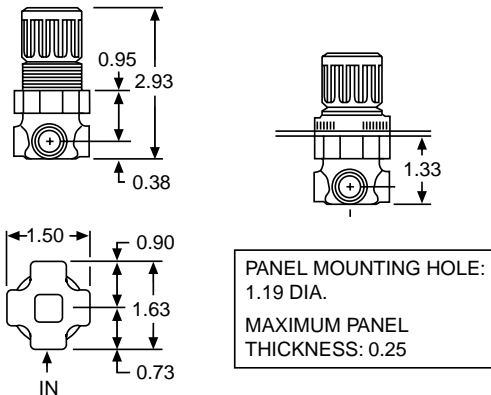

ORDER BY CATALOG NUMBER OR ITEM CODE

Port Size (NPT)	Self Relieving Regulator with Gauge		Self Relieving Regulator without Gauge	
	Catalog Number	Item Code	Catalog Number	Item Code
1/8	EN42110-G	74911	EN42110	74766
1/4	EN42120-G	74912	EN42120	74767

Port Size (NPT)	Non Relieving Regulator with Gauge		Non Relieving Regulator without Gauge	
	Catalog Number	Item Code	Catalog Number	Item Code
1/8	EN42110-WG	—	EN42110-W	—
1/4	EN42120-WG	74994	EN42120-W	74938

Specifications

Main Ports – 1/8" and 1/4" NPT
Types – Diaphragm, Self Relieving Diaphragm, Non-Relieving (-W)
Operating Conditions
Maximum Inlet Pressure – 300 PSIG
Temperature Range – 0 to 150°F
Gauge Ports – Two 1/8" NPT, full flow
Outlet Pressure Adjustment Range* –
Standard – 5 to 100 PSIG
Optional – 1 to 10 PSIG (LL)
Optional – 5 to 50 PSIG (L)

Materials

Body – Zinc
Bonnet – Acetal
Valve – Brass/Nitrile or Geolast®
Valve Seat – Acetal
Elastomers – Nitrile

*Outlet pressure adjustment ranges are not minimum or maximum outlet pressure limits. Regulators can be adjusted to zero PSIG outlet pressure and, generally, to pressures in excess of those specified. The use of these regulators to control pressures outside of the specified ranges is not recommended.

MOUNTING BRACKET

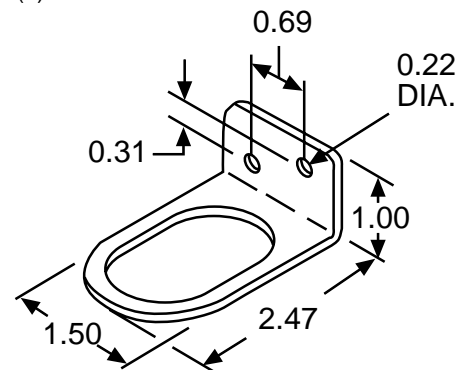

EN42108-B

Compact Models

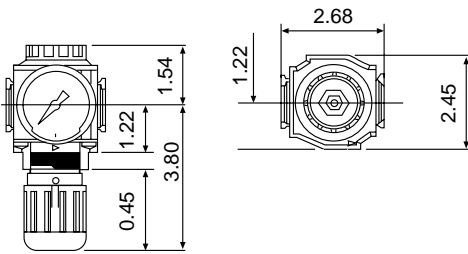

Specifications

Main Ports – 1/4", 3/8" and 1/2" PTF
 Types – Diaphragm, Self Relieving
 Operating Conditions
 Maximum Inlet Pressure – 300 PSIG
 Temperature Range – 0 to 175°F
 Gauge Ports – Two 1/4" PTF, full flow
 Outlet Pressure Adjustment Range* –
 Standard – 5 to 150 PSIG
 Optional – 5 to 60 PSIG (L)
 Optional – 10 to 250 PSIG (H)

Materials

Body – Aluminum
 Bonnet – Aluminum
 Valve – Brass
 Elastomers – Nitrile
 Bottom Plug – Acetal

*Outlet pressure adjustment ranges are not minimum or maximum outlet pressure limits. Regulators can be adjusted to zero PSIG outlet pressure and, generally, to pressures in excess of those specified. The use of these regulators to control pressures outside of the specified ranges is not recommended.

ORDER BY CATALOG NUMBER OR ITEM CODE

Port Size (PTF)	Regulator with Gauge		Regulator without Gauge	
	Catalog Number	Item Code	Catalog Number	Item Code
1/4	EN72220-G	39928	EN72220	39929
3/8	EN72230-G	39930	EN72230	39931
1/2	EN72240-G	39932	EN72240	39933

Note: To mount an FRL Assembly you may order two (2) pcs EN61308-F (39833) in place of this bracket.

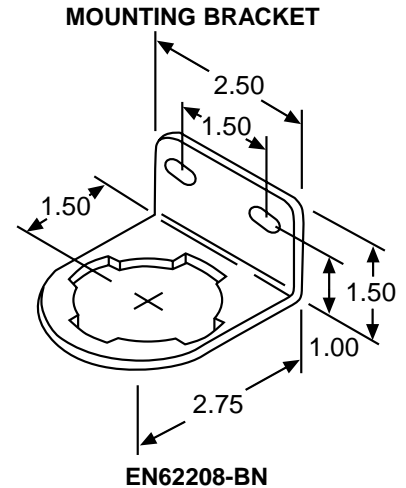

ACCESSORIES / REPAIR PARTS, PAGE 12

Standard Models

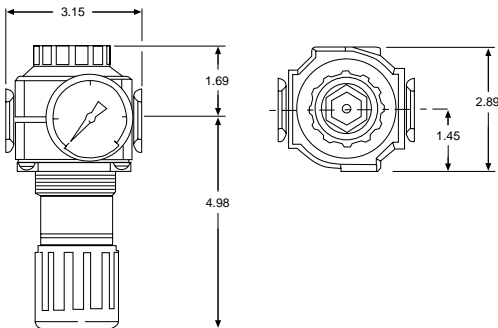

Specifications

Main Ports – 3/8", 1/2" and 3/4" PTF
 Types – Diaphragm, Self Relieving
 Operating Conditions
 Maximum Inlet Pressure – 300 PSIG
 Temperature Range – 0 to 175°F
 Gauge Ports – Two 1/4" PTF, full flow
 Outlet Pressure Adjustment Range* –
 Standard – 5 to 150 PSIG
 Optional – 5 to 60 PSIG (L)

Materials

Body – Aluminum
 Bonnet – Aluminum
 Valve – Brass
 Elastomers – Nitrile
 Bottom Plug – Acetal

*Outlet pressure adjustment ranges are not minimum or maximum outlet pressure limits. Regulators can be adjusted to zero PSIG outlet pressure and, generally, to pressures in excess of those specified. The use of these regulators to control pressures outside of the specified ranges is not recommended.

ORDER BY CATALOG NUMBER OR ITEM CODE

Port Size (PTF)	Regulator with Gauge		Regulator without Gauge	
	Catalog Number	Item Code	Catalog Number	Item Code
3/8	EN62330-G	70689	EN62330	70692
1/2	EN62340-G	70690	EN62340	70693
3/4	EN62350-G	70691	EN62350	70694

Note: To mount an FRL Assembly you may order two (2) pcs EN61308-F (39833) in place of this bracket.

MOUNTING BRACKET

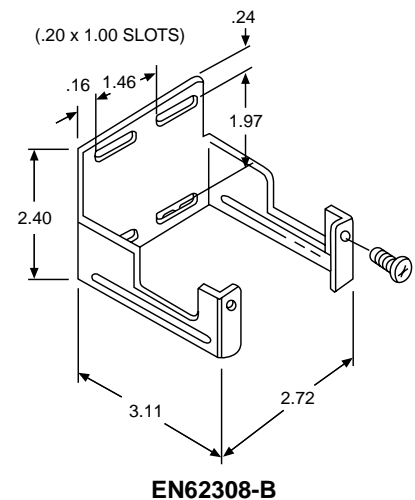

ACCESSORIES / REPAIR PARTS, PAGE 12

REGULATORS

Jumbo Models

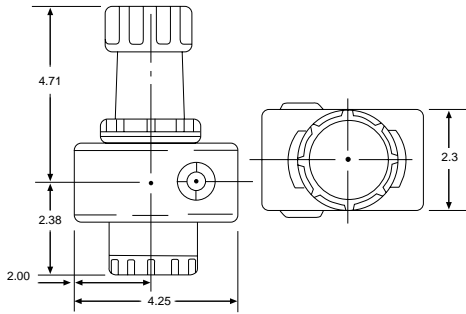

Specifications

Main Ports – 3/4", 1" 1-1/4" and 1-1/2" PTF
 Types – Diaphragm, Self Relieving
 Operating Conditions
 Maximum Inlet Pressure – 300 PSIG
 Temperature Range – 0 to 175°F
 Gauge Ports – Two 1/4" PTF, full flow
 Outlet Pressure Adjustment Range* –
 Standard – 5 to 125 PSIG
 Optional – 5 to 50 PSIG (L)
 Optional – 12 to 250 PSIG (H)

Materials

Body – Aluminum
 Bonnet – Aluminum
 Valve – Aluminum and Nylon
 Elastomers – Nitrile
 Bottom Plug – Aluminum

*Outlet pressure adjustment ranges are not minimum or maximum outlet pressure limits. Regulators can be adjusted to zero PSIG outlet pressure and, generally, to pressures in excess of those specified. The use of these regulators to control pressures outside of the specified ranges is not recommended.

ORDER BY CATALOG NUMBER OR ITEM CODE

Port Size (PTF)	Regulator with Gauge		Regulator without Gauge	
	Catalog Number	Item Code	Catalog Number	Item Code
3/4	EN42450-G	74909	EN42450	74930
1	EN42460-G	74910	EN42460	74820
1 1/4	EN42470-G	74906	EN42470	74937
1 1/2	EN42480-G	71776	EN42480	71767

MOUNTING BRACKET

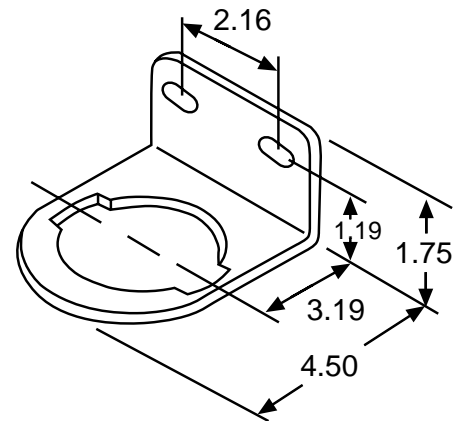

EN42408-BN

ACCESSORIES / REPAIR PARTS, BELOW

Regulator — Accessories / Repair Parts

ORDER BY CATALOG NUMBER OR ITEM CODE

Description	Miniature		Compact		Standard		Jumbo	
	Catalog Number	Item Code	Catalog Number	Item Code	Catalog Number	Item Code	Catalog Number	Item Code
Repair Kit								
Self Relieving	EN42109	70755	EN72209	39839	EN62309	70678	EN42409	74823
Non Relieving	EN42109-W	73862	EN72209-NR	39840	EN62309-W	70679	EN42409-W	73865
Adjustment Spring								
1 to 10 (LL)	EN42108-LL	70799						
5 to 50 (L)	EN42108-L	70800					EN42308-L	74992
5 to 60 (L)			EN72208-L	39847	EN62308-L	71011		
5 to 100 (Std)	EN42108	70814					EN42308	70760
5 to 125 (Std)			EN72208	39848	EN62308	71010		
5 to 150 (Std)			EN72208-H	39849			EN42308-H	70761
12 to 250 (H)								
Panel Nut	EN42108-N	74817	EN62209-NZ	70333	EN62309-N	70680		
Mounting Bracket	EN42108-B	74770			EN62308-B	70677		
Mounting Bracket With Panel Nut	EN42108-BN	74706	EN62208-BN	70336			EN42408-BN	70815
Tamper Resistant Kit	EN42108-TRN*	76814	EN72208-TR	39854	EN62308-TR	76815	EN42108-TR	74775
Connector†			EN61308-C	76812	EN61308-C	76812		
Connector with Mounting Feet†			EN61308-CB	76813	EN61308-CB	76813		
Mounting Feet†			EN61308-F	39833	EN61308-F	39833		

*Adjustment knob with locking screw

† See Page 22 For Dimensions

LUBRICATORS



Boston Gear Lubricators are used in compressed air systems to provide the proper amount of lubrication required for downstream components. Two styles of lubricators are available, the Standard and Micro-Lube. Each has its own characteristics as described below.

FEATURES

- Flow sensor design provides a nearly constant oil/air ratio over a wide range of air flows.
- All around (360°) visibility of the sight-feed dome simplifies installation and adjustment.
- Simple knob type, oil-feed control with integral sight-feed dome permits fine adjustment of oil-feed rate to provide the proper degree of lubrication at the point of need.
- Final oil-feed adjustment is easily locked with integral push-pull locking ring on the control knob. Optional *Tamper Resistant Kit* can be installed to resist unauthorized adjustment.

Boston Gear offers two styles of lubricators for use in industrial compressed air systems to lubricate air driver devices. **Standard Lubricators** are used in industrial compressed air systems to lubricate a single air tool, cylinder, valve or air motor. They inject a finely divided "fog" of oil into the air stream. One standard lubricator should be provided for each device requiring lubrication. The standard lubricators can be filled under pressure. **Micro-Lube Lubricators** inject a finely divided "Micro-Fog" of oil into the air stream, which allow usage in systems containing complex piping and multiple points of lubrication. Typical applications are air tools, cylinders, valves and air motors.

Miniature Models

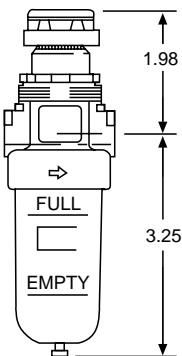
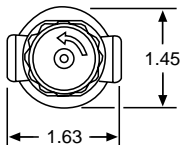

Specifications

Port Sizes – 1/8" and 1/4" NPT
 Maximum Operating Conditions
 Plastic Bowl – 150 PSIG, 125°F
 Metal Bowl – 250 PSIG, 175°F
 Bowl Capacity – 1 oz.
 Recommended Lubricants: Use a misting type oil rated 50 to 200 SSU (ISO grade 7 to 46) at 100°F. The oils must be compatible with materials of construction.

Materials

Body – Zinc
 Bowl –
 Plastic – Polycarbonate
 Metal – Zinc
 Sight Feed Dome – Transparent Nylon
 Elastomers – Neoprene and Nitrile

ORDER BY CATALOG NUMBER OR ITEM CODE

Port Size (NPT)	Recommended Flow Range* (SCFM)	Micro-Lube Lubricators	
		Catalog Number	Item Code
1/8	0.5 to 10	EN43111-F	74790
1/4	0.5 to 10	EN43121-F	74791

*At 100 PSIG inlet pressure and 5 PSID

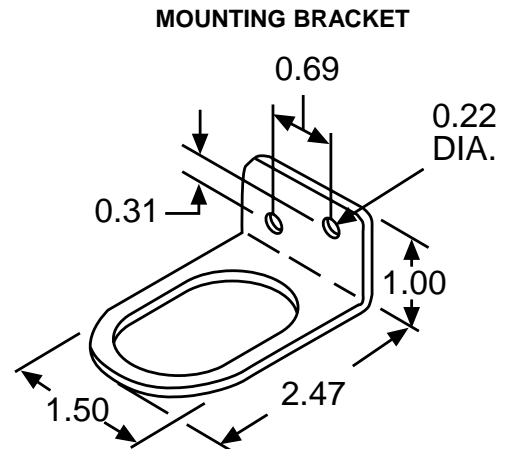

EN42108-BN

LUBRICATORS

Compact Models

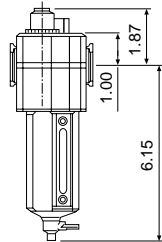
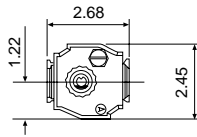

Specifications

Port Sizes – 1/4", 3/8", and 1/2" PTF
Maximum Operating Conditions
– 250 PSIG, 175°F

Bowl Capacity – 3.5 Oz.

Recommended Lubricants: Use a misting type oil rated 50 to 200 SSU (ISO grade 7 to 46) at 100°F. The oils must be compatible with materials of construction.

Materials

Body – Aluminum

Bowl – Aluminum

Sight Feed Dome – Transparent Nylon

Elastomers – Neoprene and Nitrile

Capsule (Micro-Lube) – Red Acetal

Liquid Level Indicator Lens – Transparent Nylon

ORDER BY CATALOG NUMBER OR ITEM CODE

Port Size (PTF)	Recommended Flow Range* (SCFM)	Standard Lubricators		Micro-Lube Lubricators	
		Catalog Number	Item Code	Catalog Number	Item Code
1/4	1.5 to 60	EN73220-MG	39923	EN73220-FMG	39922
3/8	1.5 to 60	EN73230-MG	39925	EN73230-FMG	39924
1/2	1.5 to 60	EN73240-MG	39927	EN73240-FMG	39926

*At 100 PSIG inlet pressure and 5 PSID

MOUNTING BRACKET

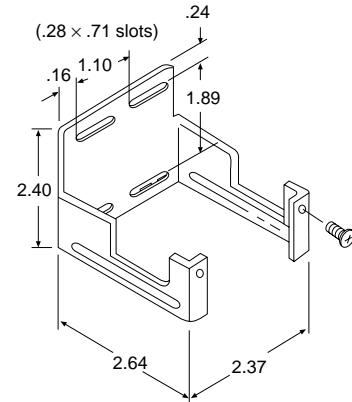

EN71208-B

ACCESSORIES / REPAIR PARTS, PAGE 15

Standard Models

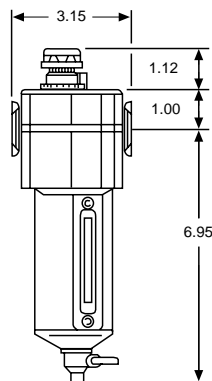
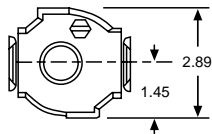

Specifications

Port Sizes – 3/8", 1/2" and 3/4" PTF
Maximum Operating Conditions
– 250 PSIG, 175°F

Bowl Capacity – 7 Oz.

Recommended Lubricants: Use a misting type oil rated 50 to 200 SSU (ISO grade 7 to 46) at 100°F. The oils must be compatible with materials of construction.

Materials

Body – Aluminum

Bowl – Aluminum

Liquid Level Indicator – Transparent Nylon

Sight Feed Dome – Transparent Nylon

Elastomers – Neoprene and Nitrile

ORDER BY CATALOG NUMBER OR ITEM CODE

Port Size (PTF)	Recommended Flow Range* (SCFM)	Standard Lubricators		Micro-Lube Lubricators	
		Catalog Number	Item Code	Catalog Number	Item Code
3/8	2.5 to 40	EN63330-MG	70041	EN63330-FMG	70042
1/2	3.5 to 100	EN63340-MG	70043	EN63340-FMG	70044
3/4	3.5 to 100	EN63350-MG	70045	EN63350-FMG	70046

*At 100 PSIG inlet pressure and 5 PSID

MOUNTING BRACKET

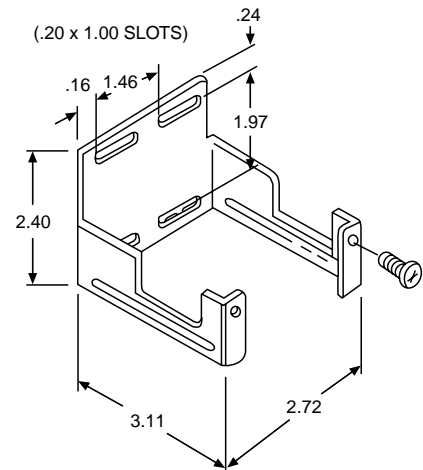

EN62308-B

ACCESSORIES / REPAIR PARTS, PAGE 15

Jumbo Models

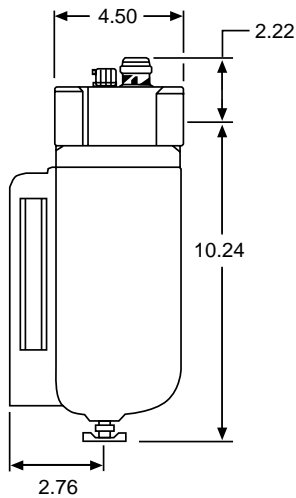

Specifications

Port Sizes – 3/4, 1", 1-1/4" and 1-1/2" PTF
 Maximum Operating Conditions – 250 PSIG, 175°F
 Bowl Capacity – 1 Qt.
 Recommended Lubricants: Use a misting type oil rated 50 to 200 SSU (ISO grade 7 to 46) at 100°F. The oils must be compatible with materials of construction.

Materials

Body – Aluminum
 Bowl – Aluminum
 Sight Glass – Pyrex
 Sight Feed Dome – Transparent Nylon
 Elastomers – Neoprene and Acetal

ORDER BY CATALOG NUMBER OR ITEM CODE

Port Size (PTF)	Recommended Flow Range* (SCFM)	Standard Lubricators		Micro-Lube Lubricators	
		Catalog Number	Item Code	Catalog Number	Item Code
3/4	8 to 160	EN43450-MG	73957	EN43450-FMG	73973
1	8 to 275	EN43460-MG	73963	EN43460-FMG	73979
1-1/4	8 to 275	EN43470-MG	73965	EN43470-FMG	73981
1-1/2	8 to 275	EN43480-MG	73971	EN43480-FMG	73983

*At 100 PSIG inlet pressure and 5 PSID

MOUNTING BRACKET

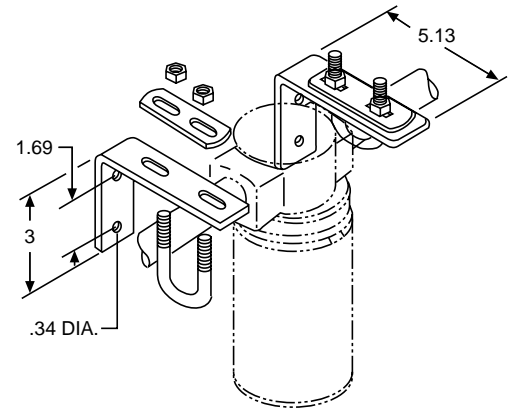

ACCESSORIES / REPAIR PARTS, BELOW

EN41408-BA
 EN41408-BB

Lubricator — Accessories / Repair Parts

ORDER BY CATALOG NUMBER OR ITEM CODE

Description	Miniature		Compact		Standard		Jumbo	
	Catalog Number	Item Code	Catalog Number	Item Code	Catalog Number	Item Code	Catalog Number	Item Code
Service Kit (Seals)	EN43109	70991	EN73209	39841	EN63309	70682	EN43409	70985
Plastic Bowl	EN43109-PB	71074	EN63209-PB	70327				
Metal Bowl	EN43109-M	—	EN73209-MG	39845	EN63309-MG	70823	EN43409-MG	71083
Sight Dome Assembly Micro-Lubricators Standard-Lubricators	EN43109-D	70992	EN73109-D	39831	EN43109-D	70992	EN43109-D	70992
			EN73209-D	39832	EN43209-D	71012	EN43209-D	71012
Fill Plug	EN43109-FP	71785	EN63209-FP	70717	EN63209-FP	70717	EN43309-FP	71787
Manual Drain Kit					EN61009	71084	EN41009	71405
Mounting Bracket All 3/4 & 1" Ports 1-1/4 & 1-1/2 Ports	EN42108-BN	74706	EN71208-B	39846	EN62308-B	70677		
							EN41408-BA	76825
							EN41408-BB	76826
Tamper Resistant Kit	EN42108-TR	74775	EN73208-TR	39830	EN42108-TR	74775	EN42108-TR	74775
Connector†			EN61308-C	76812	EN61308-C	76812		
Connector with Mounting Feet†			EN61308-CB	76813	EN61308-CB	76813		
Mounting Feet†			EN61308-F	39833	EN61308-F	39833		

† See Page 22 for Dimensions

FILTER/REGULATORS



Boston Gear's Piggy-Back Filter / Regulators are designed for general applications in compressed air systems where effective filtration and reliable, accurate pressure regulation are required. The space saving design of combining the filter and regulator into a common body reduces the amount of space needed on the air line in half.

COMBINES ALL FEATURES OF SEPARATE FILTER AND REGULATOR IN ONE EXCELLENT FLOW REGULATION AND RESPONSE TIME.

REMOVES LIQUID AND SOLID CONTAMINANTS to protect air tools and other equipment.

NON-RISING ADJUSTING KNOB with integral locking device.

BALANCED VALVE DESIGN minimizes the effect of variations in primary and secondary pressure.

EASILY DISASSEMBLED WITHOUT REMOVAL FROM AIR LINE TO SERVICE ATTRACTIVE, LIGHTWEIGHT, MODERN DESIGN STYLING.

Miniature Models

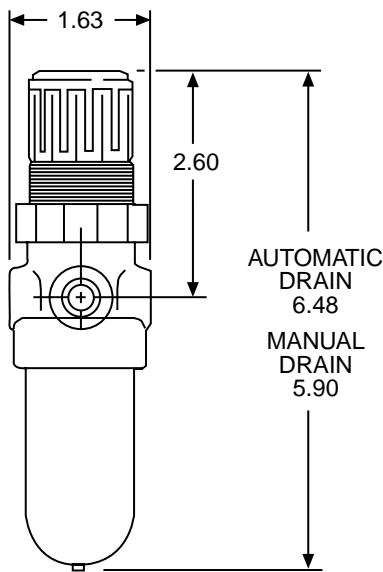

Specifications

Main Ports – 1/8" and 1/4" NPT
 Gauge Ports – Two 1/8" NPT, full flow
 Type – Diaphragm, Self Relieving
 Maximum Operating Conditions –
 Plastic Bowl – 150 PSIG, 125°F
 Metal Bowl – 250 PSIG, 175°F
 Filter Element
 Standard – 5 Micron
 Optional – 100 Micron
 Bowl
 Standard – 1/2 Oz. Plastic
 Optional – 1/2 Oz. Metal
 Drain – Manual or Automatic with
 1/4" diameter tube connection
 Outlet Pressure Adjustment Range* –
 Standard – 5 to 100 PSIG
 Optional – 1 to 10 PSIG (LL)
 Optional – 5 to 50 PSIG (L)

Materials

Body – Zinc
 Bowl
 Plastic – Polycarbonate
 Metal – Zinc
 Filter Elements – Porous Polypropylene
 Bonnet – Acetal
 Valve – Brass/Nitrile or Geolast®
 Valve Seat – Nitrile
 Elastomers – Neoprene and Nitrile

*Outlet pressure adjustment ranges are not minimum or maximum outlet pressure limits. Regulators can be adjusted to zero PSIG outlet pressure and, generally, to pressures in excess of those specified. The use of these regulators to control pressures outside of the specified ranges is not recommended.

MOUNTING BRACKET

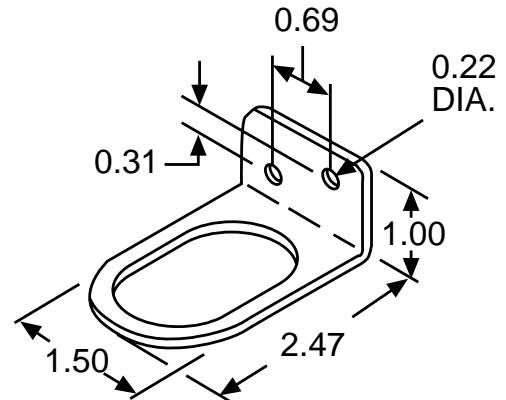

EN42108-BN

ORDER BY CATALOG NUMBER OR ITEM CODE

Port Size (NPT)	With Gauge		Without Gauge	
	Catalog Number	Item Code	Catalog Number	Item Code
AUTOMATIC DRAIN				
1/8	EN44111-G	74915	EN44111	74757
1/4	EN44121-G	74916	EN44121	74758
MANUAL DRAIN				
1/8	EN44110-G	74913	EN44110	74755
1/4	EN44120-G	74914	EN44120	74756

FILTER/REGULATORS

Compact Models

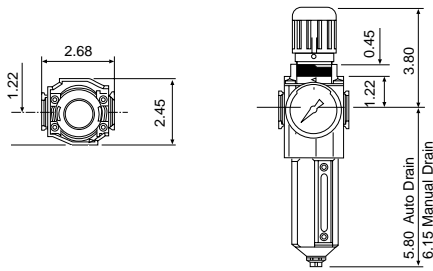

Specifications

Main Ports – 1/4", 3/8", and 1/2" PTF
 Gauge Ports – Two 1/4" PTF, full flow
 Type – Diaphragm, Self Relieving
 Maximum Operating Conditions – 250 PSIG, 175°F
 Filter Element – Standard – 40 Micron;
 Optional – 5 and 25 Micron
 Bowl – 1.9 Oz. Metal with Liquid Level Indicator
 Drain – Manual – 7/16-24 UNS Male Thread
 Automatic – 3/8 PTF Connection
 Outlet Pressure Adjustment Range* – Standard – 5 to 150 PSIG
 Optional – 5 to 60 PSIG (L)
 Optional – 10 to 250 PSIG (H)

Materials

Body–Aluminum
 Bowl–Aluminum
 Filter Elements–Sintered Polypropylene
 Bonnet–Aluminum
 Valve–Brass
 Bottom Plug–Acetal
 Elastomers–Nitrile and Neoprene
 Liquid Level Indicator–Transparent Nylon

*Outlet pressure adjustment ranges are not minimum or maximum outlet pressure limits. Regulators can be adjusted to zero PSIG outlet pressure and, generally, to pressures in excess of those specified. The use of these regulators to control pressures outside of the specified ranges is not recommended.

ORDER BY CATALOG NUMBER OR ITEM CODE

Port Size (PTF)	With Gauge		Without Gauge	
	Catalog Number	Item Code	Catalog Number	Item Code
AUTOMATIC DRAIN				
1/4	EN74221-MGG	39857	EN74221-MG	39855
3/8	EN74231-MGG	39861	EN74231-MG	39859
1/2	EN74241-MGG	39865	EN74241-MG	39863
MANUAL DRAIN				
1/4	EN74220-MGG	39858	EN74220-MG	39856
3/8	EN74230-MGG	39862	EN74230-MG	39860
1/2	EN74240-MGG	39866	EN74240-MG	39864

MOUNTING BRACKET

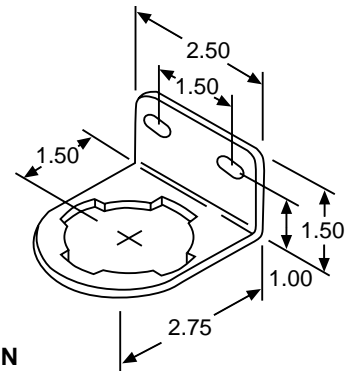

EN62208-BN

ACCESSORIES / REPAIR PARTS, PAGE 18

Standard Models

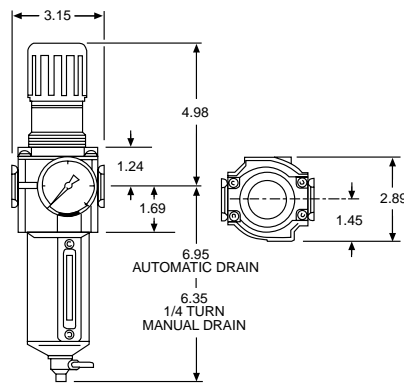

Specifications

Main Ports – 3/8", 1/2" and 3/4" PTF
 Gauge Ports – Two 1/4" PTF, full flow
 Type – Diaphragm, Self Relieving
 Maximum Operating Conditions – 250 PSIG, 175°F
 Filter Element
 Standard – 40Micron
 Optional – 5 and 75 Micron
 Bowl – 7 Oz. with Liquid Level Indicator
 Drain – Manual or Automatic with 1/8" NPTF connection
 Outlet Pressure Adjustment Range* – Standard – 5 to 150 PSIG
 Optional – 5 to 60 PSIG (L)

Materials

Body–Aluminum
 Bowl–Aluminum with Nylon Level
 Filter Elements–Porous Polypropylene
 Bonnet–Aluminum
 Valve–Brass
 Bottom Plug–Acetal
 Elastomers–Neoprene and Nitrile

*Outlet pressure adjustment ranges are not minimum or maximum outlet pressure limits. Regulators can be adjusted to zero PSIG outlet pressure and, generally, to pressures in excess of those specified. The use of these regulators to control pressures outside of the specified ranges is not recommended.

ORDER BY CATALOG NUMBER OR ITEM CODE

Port Size (PTF)	With Gauge		Without Gauge	
	Catalog Number	Item Code	Catalog Number	Item Code
AUTOMATIC DRAIN				
3/8	EN64331-MGG	70628	EN64331-MG	70629
1/2	EN64341-MGG	70630	EN64341-MG	70631
3/4	EN64351-MGG	70632	EN64351-MG	70633
MANUAL DRAIN				
3/8	EN64330-MGG	70634	EN64330-MG	70635
1/2	EN64340-MGG	70636	EN64340-MG	70637
3/4	EN64350-MGG	70638	EN64350-MG	70639

MOUNTING BRACKET

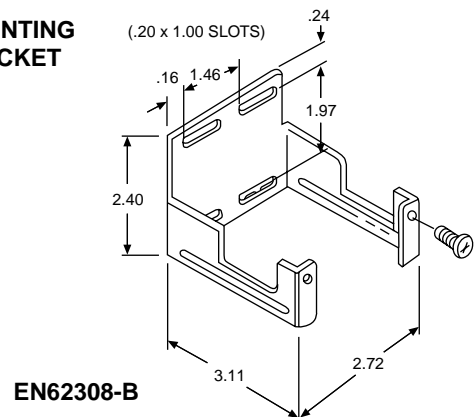

EN62308-B

ACCESSORIES / REPAIR PARTS, PAGE 18

FILTER / REGULATORS

Piggy-Back Filter/Regulator — Accessories / Repair Parts

ORDER BY CATALOG NUMBER OR ITEM CODE

Description	Miniature		Compact		Standard	
	Catalog Number	Item Code	Catalog Number	Item Code	Catalog Number	Item Code
Service Kit (Seals)	EN42109	70755	EN74209	39842	EN64309	70681
Plastic Bowl Manual Drain Automatic Drain	EN41109-PBT EN41109-PBAT	74144 74787	EN61209-PB —	70324 —		
Metal Bowl Manual Drain Automatic Drain	EN41109-MB EN41109-MAT	74142 74143	EN71209-MG EN71209-MGA	39843 39844	EN61309-MG EN61309-MGA	76811 71082
Filter Element 5 Micron 25 Micron 40 Micron 50 Micron 75 Micron 100 Micron	EN41109-5 EN41109-100	74735 ____	EN71209-5 EN71209-25 EN71209-40	39850 39851 39852	EN61309-5 EN61309-40 EN61309-75	70670 70671 _____
Automatic Drain Kit			EN71001	39829	EN41001	74752
Manual Drain Kit			EN61009	71084	EN61009	71084
Adjustment Spring 1 to 10 (LL) 5 to 50 (L) 5 to 60 (L) 5 to 100 (Std) 5 to 125 (Std) 5 to 150 (Std) 12 to 250 (H)	EN42108-LL EN42108-L EN42108	70799 70800 70814	EN72208-L EN72208 EN72208-H	39847 39848 39849	EN62308-L EN62308	71011 71010
Mounting Bracket Mounting Bracket With Panel Nut Panel Nut	EN42108-B EN42108-BN EN42108-N	74770 74706 74817	EN62208-BN EN62208-N	70336 70978	EN62308-B EN62309-N	70677 70680
Tamper Resistant Kit	EN42108-TRN*	76814	EN72208-TR	39854	EN62309-TR	76815
Connector † Connector with Mounting Feet † Mounting Feet †			EN61308-C EN61308-CB EN61308-F	76812 76813 39833	EN61308-C EN61308-CB EN61308-F	76812 76813 39833

*Adjustment knob with locking screw

† See Page 22 For Dimensions

Air Pressure Gauges



Specifications

Scale – Dual, PSI and Kpa

Dial Ranges – 0-30 PSIG

0-60 PSIG

0-160 PSIG

0-300 PSIG

Accuracy – 3%-2%-3%

Temperature Range – – 10°F to

140°F

Connection Location – Centered

on back

Materials

Case – ABS Plastic

Window – Acrylic

Bourdon Tube – Copper Alloy

Connection – Copper Alloy

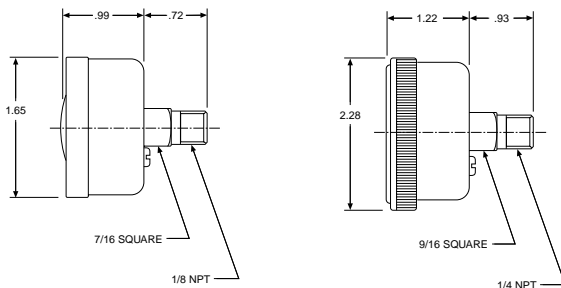

ORDER BY CATALOG NUMBER OR ITEM CODE

Pipe Size (NPT)	Pressure Range (PSIG)	Series	Catalog Number	Item Code	Use with Model
1/8	0-30	Miniature	E61-1C030	78400	-LL
	0-60		E61-1C060	78401	-L
	0-160		E61-1C0160	70515	(STD)
1/4	0-60	Compact, Standard, and Jumbo	E61-2C060	70796	-L
	0-160		E61-2C0160	70516	(STD)
	0-300		E61-2C0300	70797	-H

RELIEF VALVES



A relief valve is used in a compressed air system to retard excessive air pressure buildup and thereby help prevent damage to system components.

FEATURES

ATTRACTIVE, LIGHTWEIGHT STYLING
 STANDARD NON-RISING ADJUSTING KNOB with integral locking device which can be made tamper resistant
 INLINE MOUNTING
 EASILY DISASSEMBLED FOR SERVICING without removal from air line. (Air Pressure Off)

Miniature Models

PANEL MOUNTING

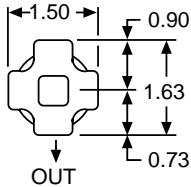
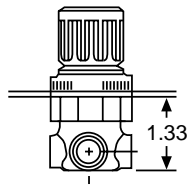
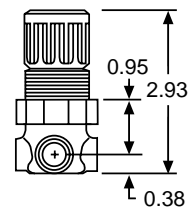

PANEL MOUNTING HOLE:
 1.19 DIA.
 MAXIMUM PANEL THICKNESS: 0.25

Specifications

Main Ports – 1/8" and 1/4" NPT
 Type – Diaphragm
 Operating Conditions –
 Maximum Inlet Pressure – 300 PSIG
 Temperature Range – 0-150°F
 Gauge Ports – Two 1/8" NPT, Full Flow
 Outlet Pressure Adjustment Range* –
 Standard – 5 to 100 PSIG
 Optional – 1 to 10 PSIG (LL)
 Optional – 2 to 50 PSIG (L)

Materials

Body – Zinc
 Bonnet – Acetal
 Valve – Brass/Nitrile or Geolast®
 Valve Seat – Acetal
 Elastomers – Nitrile

*Outlet pressure adjustment ranges are not minimum or maximum pressure limits. Relief valves can be adjusted to zero PSIG relief pressure and, generally, to pressures in excess of those specified. The use of these relief valves to control pressures outside of the specified ranges is not recommended.

ORDER BY CATALOG NUMBER OR ITEM CODE

Port Size (NPT)	Catalog Number	Item Code
1/8	EN49110	74986
1/4	EN49120	74987

Accessories/Repair Parts

Item	Catalog Number	Item Code
Adjustment Spring		
5 to 100 (Standard)	EN42108	70814
1 to 10 (LL)	EN42108-LL	70799
5 to 50 (L)	EN42108-L	70800
Panel Nut (Plastic)	EN42108-N	74817
Mounting Bracket	EN42108-B	74770
Mounting Bracket with Panel Nut	EN42108-BN	74706
Tamper Resistant Kit*	EN42108-TRN	76814

*Adjustment knob with locking screw

MOUNTING BRACKET

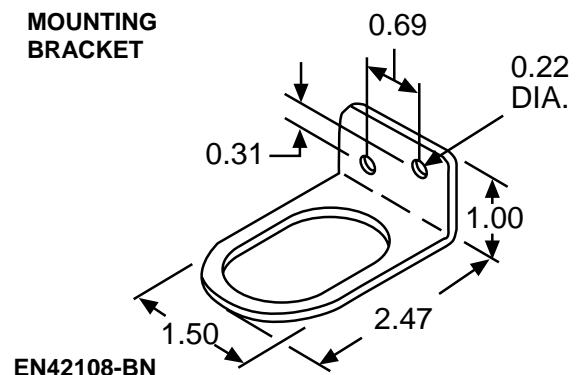

BOSTON GEAR®

Fluid Power Catalog

RELIEF VALVES

Standard Models

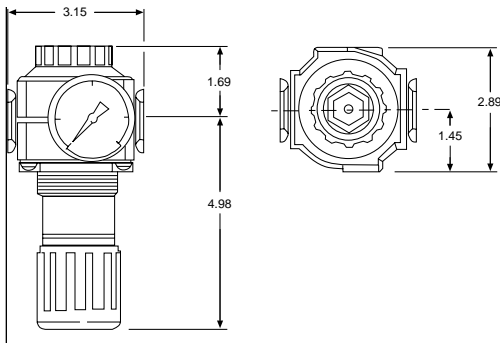

Specifications

Main Ports – 3/8", 1/2" and 3/4" PTF
 Type – Diaphragm
 Operating Conditions –
 Maximum Inlet Pressure –
 300 PSIG
 Temperature Range – 0-175°F
 Gauge Ports – Two 1/4" PTF,
 Full Flow
 Outlet Pressure Adjustment Range* –
 Standard – 5 to 150 PSIG
 Optional – 5 to 60 PSIG (L)

Materials

Body – Aluminum
 Bonnet – Aluminum
 Valve – Brass
 Elastomers – Nitrile
 Bottom Plug – Acetal

*Outlet pressure adjustment ranges are not minimum or maximum pressure limits. Relief valves can be adjusted to zero PSIG relief pressure and, generally, to pressures in excess of those specified. The use of these relief valves to control pressures outside of the specified ranges is not recommended.

ORDER BY CATALOG NUMBER OR ITEM CODE

Port Size (PTF)	Catalog Number	Item Code
3/8	EN69330	79081
1/2	EN69340	79082
3/4	EN69350	79080

Accessories/Repair Parts

Item	Catalog Number	Item Code
Adjustment Spring		
5 to 150 (Standard)	EN62308	71010
5 to 60 (L)	EN62308-L	71011
Panel Nut (Zinc)	EN62309-N	70680
Mounting Bracket	EN62308-B	70677
Tamper Resistant Kit	EN62308-TR	76815

MOUNTING BRACKET

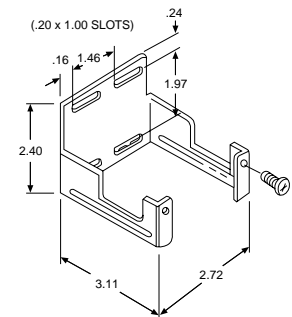

EN62308-B

Drip Leg Automatic Drain

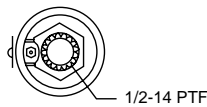

The Boston Automatic Drip Leg Drain should be installed at low points in the piping and at the far end of the distribution system where water is likely to accumulate.

Features

THREADED BOWL for easy removal
 1/8" NPT PORTED AUTOMATIC DRAIN for ease in piping away expelled liquid
 AUTOMATIC DRAIN VALVE actuated by water level on float in normal pressurized service.
 Opens when system is unpressurized, allowing water to escape by gravity.
 EASILY DISASSEMBLED and SERVICED without tools or removal from air line (air pressure off).

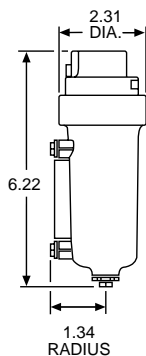

Specifications

Port Size – 1/2" NPT
 Maximum Operating Conditions – 250 PSIG,
 175°F
 Bowl Capacity – 1/3 pt. Metal Bowl with Sight Glass

Materials

Body – Zinc
 Bowl – Zinc
 Elastomers – Neoprene and Buna-N

Accessories/Repair Parts

ORDER BY CATALOG NUMBER OR ITEM CODE

Port Size NPT	Catalog Number	Item Code
1/2	EN49241-MG	74984

ORDER BY CATALOG NUMBER OR ITEM CODE

Description	Catalog Number	Item Code
Automatic Drain Kit	EN41001	74752
Metal Bowl	EN61209-MGA	70329

SHUT-OFF VALVES



Shut-Off Valves, typically attach to the inlet end of a combination unit, are manually operated, slide type valves that open and close with a short one-inch movement of the slide. The valve slide can be locked in the closed position with a customer supplied padlock. The standard valve is a 3-way valve that exhausts downstream air in the closed position.

SPECIFICATIONS

Ports – 1/4", 3/8" and 1/2" PTF
 Operating Conditions –
 Maximum Inlet Pressure – 250 PSIG
 Temperature Range – 0 to 175°F

MATERIALS

Body – Zinc
 Slide – Acetal
 Elastomers – Nitrile

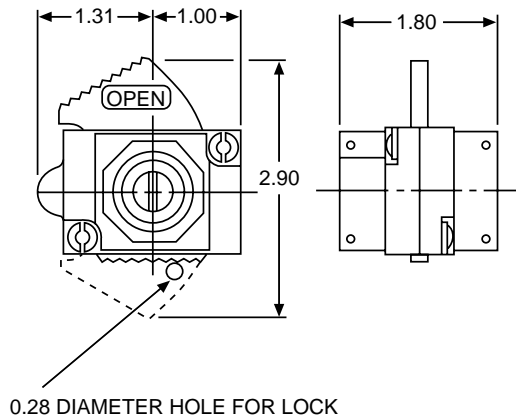

ORDER BY CATALOG NUMBER OR ITEM CODE

Port Size (PTF)	Catalog Number	Item Code
1/4	EN60223	70311
3/8	EN60233	70312
1/2	EN60243	70547

Differential Pressure Indicator

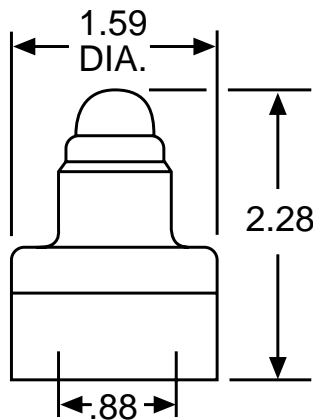

The differential pressure indicator, using the familiar "stop" and "go" colors, red and green, is used to monitor the pressure drop across air line filters and other components. It is a standard feature on all Boston Oil Removal Filters. The Differential Pressure Indicator can also be used inline to measure pressure drop across any device in an air circuit.

Color Code

GREEN: Pressure drop less than 6 psig
 GREEN/RED: Pressure drop between 6 and 15 psig
 RED: Pressure drop greater than 15 psig

Specifications

Ports – 1/8" PTF
 Maximum Rated Operating Conditions –
 250 psig, 175°F

Materials

Body – Aluminum
 Lens – Polycarbonate
 Internal Parts – Stainless Steel, ABS and Acetal
 Elastomers – Buna-N

ORDER BY CATALOG NUMBER OR ITEM CODE

Description	Catalog Number	Item Code
Differential Pressure Indicator	EN41218	74816
Replacement Unit for Oil Removal Filters	EN5796-50	74976
Service Kit	ENP0550A-02	74975

COMBINATION ASSEMBLIES

Filter – Regulator – Lubricator Combination Units

ORDER BY CATALOG NUMBER OR ITEM CODE

Port Size	Drain	Lubricator Style	Catalog Number	Item Code	Consisting of:		
					Filter	Regulator with Gauge	Lubricator
MINIATURE							
1/8 1/4	Automatic	Micro-Lube	EN45111-F EN45121-F	74939 74940	EN41111 EN41121	EN42110-G EN42120-G	EN43111-F EN43121-F
1/8 1/4	Manual	Micro-Lube	EN45110-F EN45120-F	74849 74850	EN41110 EN41120	EN42110-G EN42120-G	EN43111-F EN43121-F
COMPACT*							
1/4 3/8 1/2	Automatic	Micro-Lube	EN75221-FMG EN75231-FMG EN75241-FMG	39867 39869 39873	EN71221-MG EN71231-MG EN71241-MG	EN72220-G EN72230-G EN72240-G	EN73220-FMG EN73230-FMG EN73240-FMG
1/4 3/8 1/2	Manual	Micro-Lube	EN75220-FMG EN75230-FMG EN75240-FMG	39868 39870 39871	EN71220-MG EN71230-MG EN71240-MG	EN72220-G EN72230-G EN72240-G	EN73220-FMG EN73230-FMG EN73240-FMG
1/4 3/8 1/2	Automatic	Standard	EN75221-MG EN75231-MG EN75241-MG	39872 39875 39877	EN71221-MG EN71231-MG EN71241-MG	EN72220-G EN72230-G EN72240-G	EN73220-MG EN73230-MG EN73240-MG
1/4 3/8 1/2	Manual	Standard	EN75220-MG EN75230-MG EN75240-MG	39874 39876 39878	EN71220-MG EN71230-MG EN71240-MG	EN72220-G EN72230-G EN72240-G	EN73220-MG EN73230-MG EN73240-MG
STANDARD*							
3/8 1/2 3/4	Automatic	Micro-Lube	EN65331-FMG EN65341-FMG EN65351-FMG	70947 70948 70949	EN61331-MG EN61341-MG EN61351-MG	EN62330-G EN62340-G EN62350-G	EN63330-FMG EN63340-FMG EN63350-FMG
3/8 1/2 3/4	Manual	Micro-Lube	EN65330-FMG EN65340-FMG EN65350-FMG	70950 70951 70952	EN61330-MG EN61340-MG EN61350-MG	EN62330-G EN62340-G EN62350-G	EN63330-FMG EN63340-FMG EN63350-FMG
3/8 1/2 3/4	Automatic	Standard	EN65331-MG EN65341-MG EN65351-MG	70619 70620 70621	EN61331-MG EN61341-MG EN61351-MG	EN62330-G EN62340-G EN62350-G	EN63330-MG EN63340-MG EN63350-MG
3/8 1/2 3/4	Manual	Standard	EN65330-MG EN65340-MG EN65350-MG	70622 70623 70806	EN61330-MG EN61340-MG EN61350-MG	EN62330-G EN62340-G EN62350-G	EN63330-MG EN63340-MG EN63350-MG
JUMBO							
3/4 1 1-1/4 1-1/2	Automatic	Micro-Lube	EN45451-FMG EN45461-FMG EN45471-FMG EN45481-FMG	73899 73900 73901 73902	EN41451-MG EN41461-MG EN41471-MG EN41481-MG	EN42450-G EN42460-G EN42470-G EN42480-G	EN43450-FMG EN43460-FMG EN43470-FMG EN43480-FMG
3/4 1 1-1/4 1-1/2	Manual	Micro-Lube	EN45450-FMG EN45460-FMG EN45470-FMG EN45480-FMG	73989 73990 73991 73992	EN41450-MG EN41460-MG EN41470-MG EN41480-MG	EN42450-G EN42460-G EN42470-G EN42480-G	EN43450-FMG EN43460-FMG EN43470-FMG EN43480-FMG
3/4 1 1-1/4 1-1/2	Automatic	Standard	EN45451-MG EN45461-MG EN45471-MG EN45481-MG	73895 73896 73897 73898	EN41451-MG EN41461-MG EN41471-MG EN41481-MG	EN42450-G EN42460-G EN42470-G EN42480-G	EN43450-MG EN43460-MG EN43470-MG EN43480-MG
3/4 1 1-1/4 1-1/2	Manual	Standard	EN45450-MG EN45460-MG EN45470-MG EN45480-MG	73985 73986 73987 73988	EN41450-MG EN41460-MG EN41470-MG EN41480-MG	EN42450-G EN42460-G EN42470-G EN42480-G	EN43450-MG EN43460-MG EN43470-MG EN43480-MG

* Compact & Standard FRLs use connector (EN61308-C) To attach components, Miniature or Jumbo use brass fittings.

Dimensions, Compact and Standard Units

Connector

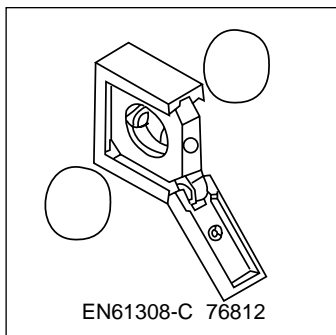

Mounting Feet

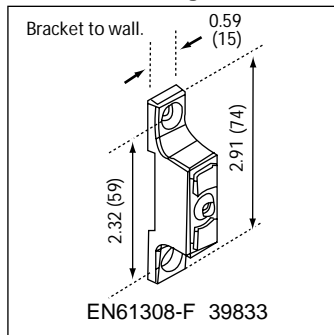

Connector With Feet

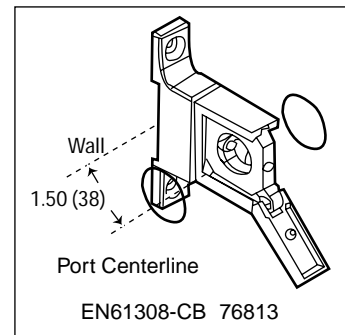

COMBINATION ASSEMBLIES

Piggy-Back Filter/Regulator – Lubricator Combination Units

ORDER BY CATALOG NUMBER OR ITEM CODE

Port Size	Drain	Lubricator Style	Catalog Number	Item Code	Consisting of:	
					Filter/Regulator with Gauge	Lubricator
MINIATURE						
1/8 1/4	Automatic	Micro-Lube	EN45115-F EN45125-F	74941 74942	EN44111-G EN44121-G	EN43111-F EN43121-F
1/8 1/4	Manual	Micro-Lube	EN45114-F EN45124-F	74851 74888	EN44110-G EN44120-G	EN43111-F EN43121-F
COMPACT*						
1/4 3/8 1/2	Automatic	Micro-Lube	EN75225-FMG EN75235-FMG EN75245-FMG	39903 39904 39906	EN74221-G EN74231-G EN74241-G	EN73220-FMG EN73230-FMG EN73240-FMG
1/4 3/8 1/2	Manual	Micro-Lube	EN75224-FMG EN75234-FMG EN75244-FMG	39902 39905 39907	EN74220-G EN74230-G EN74240-G	EN73220-FMG EN73230-FMG EN73240-FMG
1/4 3/8 1/2	Automatic	Standard	EN75225-MG EN75235-MG EN75245-MG	39908 39910 39911	EN74221-G EN74231-G EN74241-G	EN73220-MG EN73230-MG EN73240-MG
1/4 3/8 1/2	Manual	Standard	EN75224-MG EN75234-MG EN75244-MG	39909 39912 39913	EN74220-G EN74230-G EN74240-G	EN73220-MG EN73230-MG EN73240-MG
STANDARD*						
3/8 1/2 3/4	Automatic	Micro-Lube	EN65335-FMG EN65345-FMG EN65355-FMG	70741 70758 70769	EN64331-MGG EN64341-MGG EN64351-MGG	EN63330-FMG EN63340-FMG EN63350-FMG
3/8 1/2 3/4	Manual	Micro-Lube	EN65334-FMG EN65344-FMG EN65354-FMG	70752 70772 70781	EN64330-MGG EN64340-MGG EN64350-MGG	EN63330-FMG EN63340-FMG EN63350-FMG
3/8 1/2 3/4	Automatic	Standard	EN65335-MG EN65345-MG EN65355-MG	70754 71075 71076	EN64331-MGG EN64341-MGG EN64351-MGG	EN63330-MG EN63340-MG EN63350-MG
3/8 1/2 3/4	Manual	Standard	EN65334-MG EN65344-MG EN65354-MG	70756 71077 71078	EN64330-MGG EN64340-MGG EN64350-MGG	EN63330-MG EN63340-MG EN63350-MG

* Compact & Standard FRLs use connector (EN61308-C) To attach components, Miniature or Jumbo use brass fittings.

Filter – Regulator Combination Units

ORDER BY CATALOG NUMBER OR ITEM CODE

Drain	Port Size	Catalog Number	Item Code	Consisting of:	
				Filter	Regulator with Gauge
COMPACT*					
1/4 3/8 1/2	Automatic	EN76221-MG EN76231-MG EN76241-MG	39880 39882 39883	EN71221-MG EN71231-MG EN71241-MG	EN72220-G EN72230-G EN72240-G
1/4 3/8 1/2	Manual	EN76220-MG EN76230-MG EN76240-MG	39879 39881 39884	EN71220-MG EN71230-MG EN71240-MG	EN72220-G EN72230-G EN72240-G
STANDARD*					
3/8 1/2 3/4	Automatic	EN66331-MG EN66341-MG EN66351-MG	70745 70746 70747	EN61331-MG EN61341-MG EN61351-MG	EN62330-G EN62340-G EN62350-G
3/8 1/2 3/4	Manual	EN66330-MG EN66340-MG EN66350-MG	70748 70749 70813	EN61330-MG EN61340-MG EN61350-MG	EN62330-G EN62340-G EN62350-G
JUMBO					
3/4 1 1-1/4 1-1/2	Automatic	EN46451-MG EN46461-MG EN46471-MG EN46481-MG	73907 73908 73909 73910	EN41451-MG EN41461-MG EN41471-MG EN41481-MG	EN42450-G EN42460-G EN42470-G EN42480-G
3/4 1 1-1/4 1-1/2	Manual	EN46450-MG EN46460-MG EN46470-MG EN46480-MG	73903 73904 73905 73906	EN41450-MG EN41460-MG EN41470-MG EN41480-MG	EN42450-G EN42460-G EN42470-G EN42480-G

* Compact & Standard FRLs use connector (EN61308-C) To attach components, Miniature or Jumbo use brass fittings.

COMBINATION ASSEMBLIES

Filter – Lubricator Combination Units

ORDER BY CATALOG NUMBER OR ITEM CODE

Port Size	Drain	Lubricator Style	Catalog Number	Item Code	Consisting of:	
					Filter	Lubricator
MINIATURE						
1/8 1/4	Automatic	Micro-Lube	EN47111-F EN47121-F	74943 74944	EN41111 EN41121	EN43111-F EN43121-F
1/8 1/4	Manual	Micro-Lube	EN47110-F EN47120-F	74895 74896	EN41110 EN41120	EN43111-F EN43121-F
COMPACT*						
1/4 3/8 1/2	Automatic	Micro-Lube	EN77221-FMG EN77231-FMG EN77241-FMG	39888 39890 39892	EN71221-MG EN71231-MG EN71241-MG	EN73220-FMG EN73230-FMG EN73240-FMG
1/4 3/8 1/2	Manual	Micro-Lube	EN77220-FMG EN77230-FMG EN77240-FMG	39889 39891 39895	EN71220-MG EN71230-MG EN71240-MG	EN73220-FMG EN73230-FMG EN73240-FMG
1/4 3/8 1/2	Automatic	Standard	EN77221-MG EN77231-MG EN77241-MG	39896 39898 39900	EN71221-MG EN71231-MG EN71241-MG	EN73220-MG EN73230-MG EN73240-MG
1/4 3/8 1/2	Manual	Standard	EN77220-MG EN77230-MG EN77240-MG	39897 39899 39901	EN71220-MG EN71230-MG EN71240-MG	EN73220-MG EN73230-MG EN73240-MG
STANDARD*						
3/8 1/2 3/4	Automatic	Micro-Lube	EN67331-FMG EN67341-FMG EN67351-FMG	70640 70641 70642	EN61331-MG EN61341-MG EN61351-MG	EN63330-FMG EN63340-FMG EN63350-FMG
3/8 1/2 3/4	Manual	Micro-Lube	EN67330-FMG EN67340-FMG EN67350-FMG	70643 70599 70816	EN61330-MG EN61340-MG EN61350-MG	EN63330-FMG EN63340-FMG EN63350-FMG
3/8 1/2 3/4	Automatic	Standard	EN67331-MG EN67341-MG EN67351-MG	70736 70737 70743	EN61331-MG EN61341-MG EN61351-MG	EN63330-MG EN63340-MG EN63350-MG
3/8 1/2 3/4	Manual	Standard	EN67330-MG EN67340-MG EN67350-MG	70744 71072 71073	EN61330-MG EN61340-MG EN61350-MG	EN63330-MG EN63340-MG EN63350-MG
JUMBO						
3/4 1 1-1/4 1-1/2	Automatic	Micro-Lube	EN47451-FMG EN47461-FMG EN47471-FMG EN47481-FMG	73923 73924 73925 73926	EN41451-MG EN41461-MG EN41471-MG EN41481-MG	EN43450-FMG EN43460-FMG EN43470-FMG EN43480-FMG
3/4 1 1-1/4 1-1/2	Manual	Micro-Lube	EN47450-FMG EN47460-FMG EN47470-FMG EN47480-FMG	73919 73920 73921 73922	EN41450-MG EN41460-MG EN41470-MG EN41480-MG	EN43450-FMG EN43460-FMG EN43470-FMG EN43480-FMG
3/4 1 1-1/4 1-1/2	Automatic	Standard	EN47451-MG EN47461-MG EN47471-MG EN47481-MG	73915 73916 73917 73918	EN41451-MG EN41461-MG EN41471-MG EN41481-MG	EN43450-MG EN43460-MG EN43470-MG EN43480-MG
3/4 1 1-1/4 1-1/2	Manual	Standard	EN47450-MG EN47460-MG EN47470-MG EN47480-MG	73911 73912 73913 73914	EN41450-MG EN41460-MG EN41470-MG EN41480-MG	EN43450-MG EN43460-MG EN43470-MG EN43480-MG

* Compact & Standard FRLs use connector (EN61308-C) To attach components, Miniature or Jumbo use brass fittings.



Table of Contents

	Page
E25 Series—Disposable Cylinders	26-40
BE10 Series—Medium Duty Pneumatic Cylinders	41-48
BE11 Series—Heavy Duty Pneumatic Cylinders	49-57
BJ11 Series—Medium Duty Hydraulic Cylinders	49-57
Repair Kits	58-59
Cylinder Force Chart	60-61
Cylinder Mounting Accessories	62-63

Selection Chart

Series	Bore Sizes	Operating Pressures (PSIG)	
		Pneumatic	Hydraulic
E25	7/16 – 2-1/2"	250	—
BE10	1-1/2 – 6"	250	500 (Non-Shock)
BE11	1-1/2 – 8"	250	500 (Non-Shock)
BJ11	1-1/2 – 8"	—	500-2000

DISPOSABLE CYLINDERS

E25 Series

Boston Gear E25 Series, stainless steel body, disposable air cylinders have been designed using materials specifically selected for optimum performance and long service life! Each component is precision machined, assembled and tested for exacting quality standards using state-of-the-art equipment and cylinder technology.

The E25 Series cylinders are dimensionally interchangeable with many other manufacturers. See guide on pages 38 & 39.



Material Specifications

1. **HEAD/CAP:** Precision machined from 2011-T3 solid aluminum alloy for strength and durability. "V" grooves in the face of the head and cap provide maximum air flow for fast response.
2. **CYLINDER BODY:** Type 304 stainless steel with a drawn and polished internal diameter which ensures smooth performance and outstanding cycle life. The body is secured to the head and cap using double rolled in construction.
3. **PISTON ROD:** Type 303 stainless steel which is hard chrome plated, ground and polished for extended rod seal life; non-rotating rod cylinders use a carbon steel piston rod.
4. **ROD THREADS:** Roll-formed for superior strength and resistance to wear or breakage.
5. **WRENCH FLATS:** Broached wrench flats are standard on most models.
6. **PISTON:** Solid aluminum alloy (2011-T3) which is strong yet lightweight for low inertia. The piston is spin riveted to roll formed piston rod threads for maximum strength.
7. **PISTON SEALS:** Lip type nitrile seals are pressure energized and wear compensating. Excellent lubricant retention characteristics reduce seal friction, ensuring long life.
8. **BEARING:** Oil impregnated sintered bronze provides exceptional rod support, smooth rod movement and optimum cycle life.
9. **ROD SEAL:** Lip type nitrile which is pressure energized and wear compensating.
10. **PRESSURE PORTS:** Full, unrestricted porting for maximum air flow.
11. **SPRINGS:** The springs used on single acting models are manufactured from music wire and are designed for literally millions of trouble free cycles.

SPECIFICATIONS

Pressure Rating:	250 PSI AIR
Temperature Limits:	Standard Nitrile -20° to 200°F Viton Seals -50° to 450°F
Fluids:	Compressed Air
Lubrication:	All E25 stainless steel body air cylinders are prelubricated at the time of assembly with a Teflon® based grease. Cylinder life could be enhanced with the use of a properly maintained, air line mist lubricator. In the absence of a lubricator, it is recommended that a non-detergent, mineral base oil be directly introduced to the cylinder periodically.
Side Loading:	Cylinders are specifically designed to push and pull. Side loading of the piston rod should be avoided to ensure maximum operating performance and life. Care should be taken during installation to properly align the load to be moved with the centerline of the cylinder.

DISPOSABLE CYLINDERS

How to Order Cylinders

The E25 Series of disposable cylinders are stocked in a variety of bore, stroke and mounting combinations.

Example: Required cylinder — Disposable cylinder, 3/4" dia. bore, double end mount, double acting, non cushioned, standard port position and 1-1/2 inch stroke.

E25	08	DS	1	1	01	4
Series	Code No. Bore Dia.	Code No. Mounting*	Code No. Cushions and Rod	Code No. Port Position	Stroke in Code Whole Inches	Stroke in Code Fractions No. of Inches
E25 Stainless Steel Disposable Cylinders	04 - 7/16"	DC - Double Acting, Pivot Mount	1 - Non-Cushioned	1 - Standard	00 - 0"	0 - 0"
	06 - 9/16"	DR - Double Acting, Double Rod End, Double End Mount			01 - 1"	4 - 1/2"
	08 - 3/4"	DS - Double Acting, Double End Mount			02 - 2"	
	10 - 1-1/16"	DX - Double Acting, Nose Mount			03 - 3"	
	12 - 1-1/4"	NC - Single Acting, Non-Rotating, Pivot Mount			04 - 4"	
	15 - 1-1/2"	NX - Single Acting, Non-Rotating, Nose Mount			05 - 5"	
	20 - 2"	PC - Reverse Single Acting, Pivot Mount			06 - 6"	
	25 - 2-1/2"	PX - Reverse Single Acting, Nose Mount				
		SC - Single Acting, Pivot Mount				
		SX - Single Acting, Nose Mount				

Available Bore/Mounting Combinations

Style	Mounting Style	Bore Diameter (CODE)								Page
		7/16" (04)	9/16" (06)	3/4" (08)	1-1/16" (10)	1-1/4" (12)	1-1/2" (15)	2" (20)	2-1/2" (25)	
Single Acting	Nose Mount	X	X	X	X	X	X	X		37
	Pivot Mount	X	X	X	X	X	X	X		36
Single Acting Non-Rotating	Nose Mount	X	X	X	X	X	X			33
	Pivot Mount	X	X	X	X	X	X			32
Reverse Single Acting	Nose Mount	X	X	X	X	X	X	X		35
	Pivot Mount	X	X	X	X	X	X	X		34
Double Acting	Nose Mount	X	X	X	X	X	X	X	X	31
	Pivot Mount	X	X	X	X	X	X	X	X	28
	Double End Mount	X	X	X	X	X	X	X	X	30
Double Acting Double Rod End	Double End Mount	X	X	X	X	X	X	X	X	29

Force Factors And Spring Forces

Bore	Force Factor		Approximate Spring Force (Lbs)	
	Extend	Retract	Retracted*	Extended*
7/16	.15	.12	1	2
9/16	.25	.22	2	4
3/4	.44	.39	3	6
1-1/16	.89	.61	3	6
1-1/4	1.23	1.08	7.5	15
1-1/2	1.77	1.62	6	12
2	3.14	2.84	15	30
2-1/2	4.91	4.61	N/A	N/A

Double Acting Cylinder Output Force (lbs) = Force Factor x Air Line Pressure (PSI)

Single Acting Cylinder Output Force (lbs) = Force Factor x Air Line Pressure (PSI) – Spring Force

* Single acting models. For reverse single acting models, the retracted and extended valves are reversed.

DISPOSABLE CYLINDERS

DC – Double Acting, Pivot Mount

E25 Series
250 PSIG Air
7/16" to 2-1/2" Bore

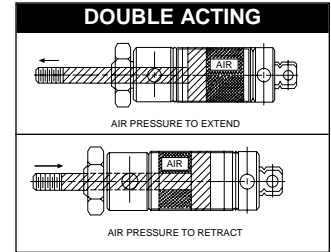

ORDER BY CATALOG NUMBER OR ITEM CODE

Bore	Stroke	Boston Gear Catalog Number	Item Code
7/16	1/2	E25-04DC1-1004	71138
	1	E25-04DC1-1010	71139
	1 1/2	E25-04DC1-1014	71140
	2	E25-04DC1-1020	71141
	3	E25-04DC1-1030	71142
	4	E25-04DC1-1040	71143
	5	E25-04DC1-1050	71144
9/16	1/2	E25-06DC1-1004	71212
	1	E25-06DC1-1010	71213
	1 1/2	E25-06DC1-1014	71214
	2	E25-06DC1-1020	71215
	3	E25-06DC1-1030	71216
	4	E25-06DC1-1040	71217
	3/4	1/2	E25-08DC1-1004
1		E25-08DC1-1010	71395
1 1/2		E25-08DC1-1014	71396
2		E25-08DC1-1020	71397
3		E25-08DC1-1030	71400
4		E25-08DC1-1040	71412
5		E25-08DC1-1050	71413
1 1/16	1	E25-10DC1-1010	71564
	2	E25-10DC1-1020	71565
	3	E25-10DC1-1030	71566
	4	E25-10DC1-1040	71568
	5	E25-10DC1-1050	71569
	6	E25-10DC1-1060	71570

ORDER BY CATALOG NUMBER OR ITEM CODE

Bore	Stroke	Boston Gear Catalog Number	Item Code
1 1/4	1	E25-12DC1-1010	71686
	2	E25-12DC1-1020	71687
	3	E25-12DC1-1030	71689
	4	E25-12DC1-1040	71690
	5	E25-12DC1-1050	71691
	6	E25-12DC1-1060	71696
1 1/2	1	E25-15DC1-1010	71783
	2	E25-15DC1-1020	71784
	3	E25-15DC1-1030	71788
	4	E25-15DC1-1040	71789
	5	E25-15DC1-1050	71790
	6	E25-15DC1-1060	71791
2	1	E25-20DC1-1010	73024
	2	E25-20DC1-1020	73025
	3	E25-20DC1-1030	73029
	4	E25-20DC1-1040	73030
	5	E25-20DC1-1050	73032
	6	E25-20DC1-1060	73034
2 1/2	1	E25-25DC1-1010	73086
	2	E25-25DC1-1020	73087
	3	E25-25DC1-1030	73088
	4	E25-25DC1-1040	73089
	5	E25-25DC1-1050	73090
	6	E25-25DC1-1060	73091

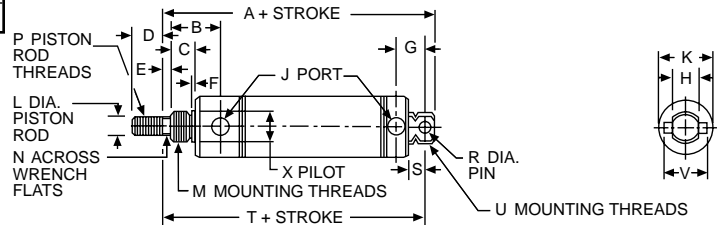

ALL DIMENSIONS IN INCHES

Bore	A	B	C	D	E	F	G	H	J	K	L	M	N	P	R	S	T	U	V	X
7/16	2.81	.72	.38	.50	—	.05	.44	.31	10-32	.74	.18	7/16-20	—	10-32	.156	.25	2.56	7/16-20	.50	.434/.437
9/16	2.75	.75	.38	.50	—	.06	.38	.31	10-32	.62	.18	7/16-20	—	10-32	.156	.25	2.56	7/16-20	.50	.434/.437
3/4	4.03	.97	.50	.50	—	.09	.62	.38	1/8 NPT	.86	.25	5/8-18	—	1/4-28	.250	.34	3.75	5/8-18	.75	.621/.624
1 1/16	4.12	1.07	.50	.50	.12	.09	.62	.38	1/8 NPT	1.12	.31	5/8-18	.25	5/16-24	.250	.34	3.84	5/8-18	.75	.621/.624
1 1/4	5.12	1.37	.63	.75	.25	.09	.78	.50	1/8 NPT	1.34	.43	3/4-16	.38	7/16-20	.250	.41	4.72	3/4-16	.88	.746/.749
1 1/2	4.76	1.25	.63	.75	.25	.09	.81	.62	1/8 NPT	1.56	.43	3/4-16	.38	7/16-20	.375	.50	4.38	N/A	1.00	.746/.749
2	6.06	1.46	.81	.88	.38	.12	1.03	.75	1/4 NPT	2.08	.62	1 1/4-12	.50	1/2-20	.375	.56	5.62	1 1/4-12	1.63	1.372/1.375
2 1/2	6.06	1.46	.81	.88	.38	.12	1.03	.75	1/4 NPT	2.62	.62	1 3/8-12	.50	1/2-20	.375	.56	5.62	1 3/8-12	1.63	1.497/1.500

DISPOSABLE CYLINDERS

DR – Double Acting, Double Rod End, Double End Mount

**E25 Series
250 PSIG Air
7/16" to 2-1/2" Bore**

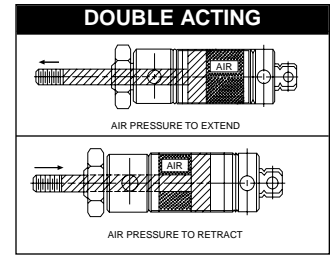

ORDER BY CATALOG NUMBER OR ITEM CODE

Bore	Stroke	Boston Gear Catalog Number	Item Code
7/16	1/2	E25-04DR1-1004	71162
	1	E25-04DR1-1010	71163
	1 1/2	E25-04DR1-1014	71164
	2	E25-04DR1-1020	71165
	3	E25-04DR1-1030	71166
	4	E25-04DR1-1040	71167
	5	E25-04DR1-1050	71168
9/16	1/2	E25-06DR1-1004	71224
	1	E25-06DR1-1010	71225
	1 1/2	E25-06DR1-1014	71226
	2	E25-06DR1-1020	71227
	3	E25-06DR1-1030	71228
	4	E25-06DR1-1040	71242
	3/4	1/2	E25-08DR1-1004
1		E25-08DR1-1010	71487
1 1/2		E25-08DR1-1014	71493
2		E25-08DR1-1020	71498
3		E25-08DR1-1030	71499
4		E25-08DR1-1040	71500
1 1/16		1	E25-10DR1-1010
	2	E25-10DR1-1020	71582
	3	E25-10DR1-1030	71583
	4	E25-10DR1-1040	71584
	5	E25-10DR1-1050	71585
	6	E25-10DR1-1060	71586

ORDER BY CATALOG NUMBER OR ITEM CODE

Bore	Stroke	Boston Gear Catalog Number	Item Code
1 1/4	1	E25-12DR1-1010	71703
	2	E25-12DR1-1020	71705
	3	E25-12DR1-1030	71706
	4	E25-12DR1-1040	71707
	5	E25-12DR1-1050	71710
	6	E25-12DR1-1060	71712
1 1/2	1	E25-15DR1-1010	71798
	2	E25-15DR1-1020	71799
	3	E25-15DR1-1030	71836
	4	E25-15DR1-1040	71840
	5	E25-15DR1-1050	71932
	6	E25-15DR1-1060	71934
2	1	E25-20DR1-1010	73064
	2	E25-20DR1-1020	73065
	3	E25-20DR1-1030	73068
	4	E25-20DR1-1040	73073
	5	E25-20DR1-1050	73075
	6	E25-20DR1-1060	73076
2 1/2	1	E25-25DR1-1010	73098
	2	E25-25DR1-1020	73099
	3	E25-25DR1-1030	73100
	4	E25-25DR1-1040	73101
	5	E25-25DR1-1050	73102
	6	E25-25DR1-1060	73103

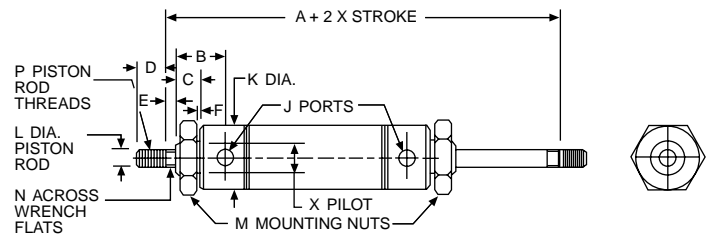

ALL DIMENSIONS IN INCHES

Bore	A	B	C	D	E	F	J	K	L	M	N	P	X
7/16	2.81	.72	.38	.50	—	.05	10-32	.74	.19	7/16-20	—	10-32	.434/.437
9/16	2.94	.75	.38	.50	—	.06	10-32	.62	.19	7/16-20	—	10-32	.434/.437
3/4	4.00	.97	.50	.50	—	.09	1/8 NPT	.86	.25	5/8-18	—	1/4-28	.621/.624
1 1/16	4.00	1.06	.50	.50	.12	.09	1/8 NPT	1.12	.31	5/8-18	.25	5/16-24	.621/.624
1 1/4	5.56	1.37	.63	.75	.25	.09	1/8 NPT	1.34	.43	3/4-16	.38	7/16-20	.746/.749
1 1/2	5.12	1.25	.63	.75	.25	.09	1/8 NPT	1.56	.43	3/4-16	.38	7/16-20	.746/.749
2	6.56	1.46	.81	.88	.38	.12	1/4 NPT	2.08	.62	1 1/4-12	.50	1/2-20	1.372/1.375
2 1/2	6.56	1.46	.81	.88	.38	.12	1/4 NPT	2.62	.62	1 3/8-12	.50	1/2-20	1.497/1.500

See page 27 for Force Factors.

BOSTON GEAR®

Fluid Power Catalog

DISPOSABLE CYLINDERS

DS – Double Acting, Double End Mount

E25 Series
250 PSIG Air
7/16" to 2-1/2" Bore

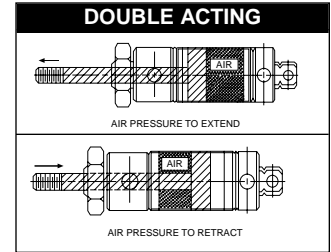

ORDER BY CATALOG NUMBER OR ITEM CODE

Bore	Stroke	Boston Gear Catalog Number	Item Code
7/16	1/2	E25-04DS1-1004	71146
	1	E25-04DS1-1010	71147
	1 1/2	E25-04DS1-1014	71148
	2	E25-04DS1-1020	71149
	3	E25-04DS1-1030	71150
	4	E25-04DS1-1040	71151
	5	E25-04DS1-1050	71156
9/16	1/2	E25-06DS1-1004	71218
	1	E25-06DS1-1010	71219
	1 1/2	E25-06DS1-1014	71220
	2	E25-06DS1-1020	71221
	3	E25-06DS1-1030	71222
	4	E25-06DS1-1040	71223
	3/4	1/2	E25-08DS1-1004
1		E25-08DS1-1010	71472
1 1/2		E25-08DS1-1014	71473
2		E25-08DS1-1020	71475
3		E25-08DS1-1030	71480
4		E25-08DS1-1040	71481
5		E25-08DS1-1050	71483
1 1/16	1/2	E25-10DS1-1010	71571
	1	E25-10DS1-1020	71572
	1 1/2	E25-10DS1-1030	71573
	2	E25-10DS1-1040	71574
	3	E25-10DS1-1050	71575
	4	E25-10DS1-1060	71484
	6	E25-10DS1-1060	71576

ORDER BY CATALOG NUMBER OR ITEM CODE

Bore	Stroke	Boston Gear Catalog Number	Item Code
1 1/4	1	E25-12DS1-1010	71697
	2	E25-12DS1-1020	71698
	3	E25-12DS1-1030	71699
	4	E25-12DS1-1040	71700
	5	E25-12DS1-1050	71701
	6	E25-12DS1-1060	71702
1 1/2	1	E25-15DS1-1010	71792
	2	E25-15DS1-1020	71793
	3	E25-15DS1-1030	71794
	4	E25-15DS1-1040	71795
	5	E25-15DS1-1050	71796
	6	E25-15DS1-1060	71797
2	1	E25-20DS1-1010	73037
	2	E25-20DS1-1020	73051
	3	E25-20DS1-1030	73055
	4	E25-20DS1-1040	73058
	5	E25-20DS1-1050	73059
	6	E25-20DS1-1060	73062
2 1/2	1	E25-25DS1-1010	73092
	2	E25-25DS1-1020	73093
	3	E25-25DS1-1030	73094
	4	E25-25DS1-1040	73095
	5	E25-25DS1-1050	73096
	6	E25-25DS1-1060	73097

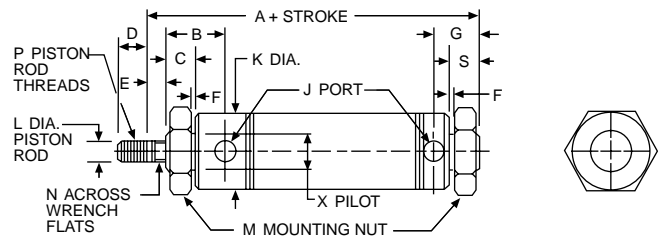

ALL DIMENSIONS IN INCHES

Bore	A	B	C	D	E	F	G	J	K	L	M	N	P	S	X
7/16	2.81	.73	.38	.50	—	.05	.69	10-32	.74	.18	7/16-20	—	10-32	.50	.434/.437
9/16	2.75	.75	.38	.50	—	.06	.57	10-32	.62	.18	7/16-20	—	10-32	.44	.434/.437
3/4	4.03	.97	.50	.50	—	.09	.90	1/8 NPT	.86	.25	5/8-18	—	1/4-28	.62	.621/.624
1 1/16	4.12	1.07	.50	.50	.12	.09	.90	1/8 NPT	1.12	.31	5/8-18	.25	5/16-24	.62	.621/.624
1 1/4	5.12	1.37	.63	.75	.25	.09	1.18	1/8 NPT	1.34	.43	3/4-16	.38	7/16-20	.81	.746/.749
1 1/2	4.50	1.25	.63	.75	.25	.09	.94	1/8 NPT	1.56	.43	3/4-16	.38	7/16-20	.62	.746/.749
2	6.06	1.46	.81	.88	.38	.12	1.47	1/4 NPT	2.08	.62	1 1/4-12	.50	1/2-20	1.00	1.372/1.375
2 1/2	6.06	1.46	.81	.88	.38	.12	1.47	1/4 NPT	2.62	.62	1 3/8-12	.50	1/2-20	1.00	1.497/1.500

BOSTON GEAR®

See page 27 for Force Factors.

DISPOSABLE CYLINDERS

DX – Double Acting, Nose Mount

**E25 Series
250 PSIG Air
7/16" to 2-1/2" Bore**

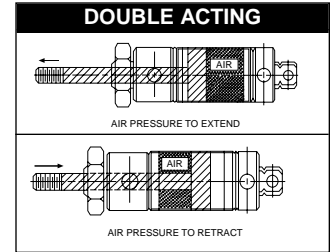

ORDER BY CATALOG NUMBER OR ITEM CODE

Bore	Stroke	Boston Gear Catalog Number	Item Code
7/16	1/2	E25-04DX1-1004	71132
	1	E25-04DX1-1010	71133
	1 1/2	E25-04DX1-1014	71134
	2	E25-04DX1-1020	71135
	3	E25-04DX1-1030	71136
	4	E25-04DX1-1040	71137
9/16	1/2	E25-06DX1-1004	71206
	1	E25-06DX1-1010	71207
	1 1/2	E25-06DX1-1014	71208
	2	E25-06DX1-1020	71209
	3	E25-06DX1-1030	71210
	4	E25-06DX1-1040	71211
3/4	1/2	E25-08DX1-1004	71380
	1	E25-08DX1-1010	71382
	1 1/2	E25-08DX1-1014	71384
	2	E25-08DX1-1020	71385
	3	E25-08DX1-1030	71386
	4	E25-08DX1-1040	71391
	5	E25-08DX1-1050	71392
	6	E25-08DX1-1060	71393
1 1/16	1	E25-10DX1-1010	71555
	2	E25-10DX1-1020	71556
	3	E25-10DX1-1030	71557
	4	E25-10DX1-1040	71558
	5	E25-10DX1-1050	71559
	6	E25-10DX1-1060	71562

ORDER BY CATALOG NUMBER OR ITEM CODE

Bore	Stroke	Boston Gear Catalog Number	Item Code
1 1/4	1	E25-12DX1-1010	71676
	2	E25-12DX1-1020	71677
	3	E25-12DX1-1030	71678
	4	E25-12DX1-1040	71679
	5	E25-12DX1-1050	71680
	6	E25-12DX1-1060	71682
1 1/2	1	E25-15DX1-1010	71774
	2	E25-15DX1-1020	71775
	3	E25-15DX1-1030	71779
	4	E25-15DX1-1040	71780
	5	E25-15DX1-1050	71781
	6	E25-15DX1-1060	71782
2	1	E25-20DX1-1010	73018
	2	E25-20DX1-1020	73019
	3	E25-20DX1-1030	73020
	4	E25-20DX1-1040	73021
	5	E25-20DX1-1050	73022
	6	E25-20DX1-1060	73023
2 1/2	1	E25-25DX1-1010	73077
	2	E25-25DX1-1020	73078
	3	E25-25DX1-1030	73082
	4	E25-25DX1-1040	73083
	5	E25-25DX1-1050	73084
	6	E25-25DX1-1060	73085

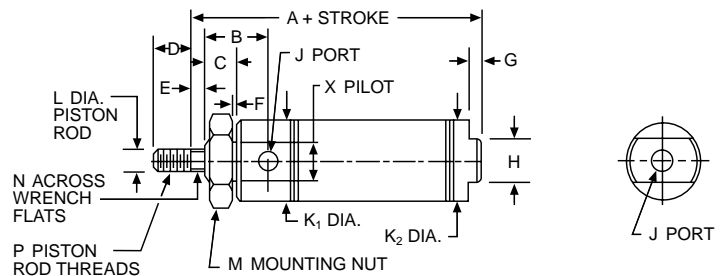

ALL DIMENSIONS IN INCHES

Bore	A	B	C	D	E	F	G	H	J	K1	K2	L	M	N	P	X
7/16	2.12	.72	.38	.50	—	.05	.19	.38	10-32	.74	.50	.18	7/16-20	—	10-32	.434/.437
9/16	2.28	.75	.38	.50	—	.06	.19	.50	10-32	.62	.62	.18	7/16-20	—	10-32	.434/.437
3/4	2.97	.97	.50	.50	—	.09	.19	.62	1/8 NPT	.86	.81	.25	5/8-18	—	1/4-28	.621/.624
1 1/16	3.12	1.06	.50	.50	—	.09	.19	.88	1/8 NPT	1.12	1.12	.31	5/8-18	—	5/16-24	.621/.624
1 1/4	4.00	1.37	.63	.75	.25	.09	.25	.88	1/8 NPT	1.34	1.34	.43	3/4-16	.38	7/16-20	.746/.749
1 1/2	3.69	1.25	.63	.75	.25	.09	.25	.88	1/8 NPT	1.56	1.56	.43	3/4-16	.38	7/16-20	.746/.749
2	4.69	1.46	.81	.88	.38	.12	.31	1.25	1/4 NPT	2.08	2.08	.62	1 1/4-12	.50	1/2-20	1.372/1.375
2 1/2	4.69	1.46	.81	.88	.38	.12	.31	1.75	1/4 NPT	2.62	2.62	.62	1 3/8-12	.50	1/2-20	1.497/1.500

See page 27 for Force Factors.

BOSTON GEAR®

DISPOSABLE CYLINDERS

NC - Single Acting, Non-Rotating, Pivot Mount

E25 Series
250 PSIG Air
7/16" to 1-1/2" Bore

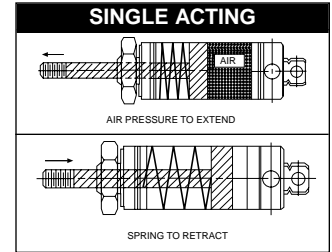

ORDER BY CATALOG NUMBER OR ITEM CODE

Bore	Stroke	Boston Gear Catalog Number	Item Code
7/16	1/2	E25-04NC1-1004	71114
	1	E25-04NC1-1010	71115
	1 1/2	E25-04NC1-1014	71116
	2	E25-04NC1-1020	71117
	3	E25-04NC1-1030	71118
	4	E25-04NC1-1040	71119
9/16	1/2	E25-06NC1-1004	71188
	1	E25-06NC1-1010	71189
	1 1/2	E25-06NC1-1014	71190
	2	E25-06NC1-1020	71191
	3	E25-06NC1-1030	71192
	4	E25-06NC1-1040	71193
3/4	1/2	E25-08NC1-1004	71338
	1	E25-08NC1-1010	71339
	1 1/2	E25-08NC1-1014	71343
	2	E25-08NC1-1020	71344
	3	E25-08NC1-1030	71345
	4	E25-08NC1-1040	71346

ORDER BY CATALOG NUMBER OR ITEM CODE

Bore	Stroke	Boston Gear Catalog Number	Item Code
1 1/16	1	E25-10NC1-1010	71539
	2	E25-10NC1-1020	71540
	3	E25-10NC1-1030	71542
	4	E25-10NC1-1040	71545
1 1/4	1	E25-12NC1-1010	71634
	2	E25-12NC1-1020	71636
	3	E25-12NC1-1030	71637
1 1/2	1	E25-15NC1-1010	71757
	2	E25-15NC1-1020	71758
	3	E25-15NC1-1030	71759
	4	E25-15NC1-1040	71760

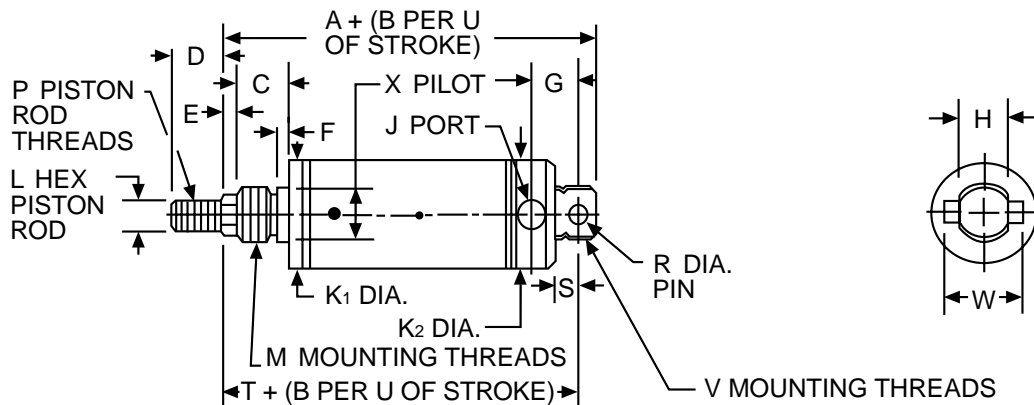

ALL DIMENSIONS IN INCHES

Bore	A	B	C	D	E	F	G	H	J	K ₁	K ₂	L	M	P	R	S	T	U	V	W	X
7/16	2.25	.94	.31	.50	.25	.05	.44	.31	10-32	.50	.74	.19	3/8-24	10-32	.156	.25	2.00	.50	7/16-20	.50	.369/.373
9/16	2.25	1.62	.38	.50	.25	.06	.38	.31	10-32	.62	.62	.19	7/16-20	10-32	.156	.25	2.06	1.00	7/16-20	.50	.434/.437
3/4	2.81	1.69	.44	.50	.25	.08	.62	.38	1/8 NPT	.81	.86	.25	1/2-20	1/4-28	.250	.34	2.53	1.00	5/8-18	.75	.494/.498
1 1/16	3.06	1.56	.50	.50	.25	.07	.62	.38	1/8 NPT	1.12	1.12	.38	5/8-18	5/16-24	.250	.34	2.78	1.00	5/8-18	.75	.621/.624
1 1/4	3.78	1.81	.63	.88	.25	.09	.78	.50	1/8 NPT	1.34	1.34	.43	3/4-16	7/16-20	.250	.41	3.38	1.00	3/4-16	.88	.746/.749
1 1/2	3.62	1.69	.63	.88	.38	.09	.81	.62	1/8 NPT	1.56	1.56	.43	3/4-16	7/16-20	.375	.50	3.25	1.00	—	1.00	.746/.749

See page 27 for Force Factors and Spring Forces

BOSTON GEAR®

DISPOSABLE CYLINDERS

NX - Single Acting, Non-Rotating, Nose Mount

**E25 Series
250 PSIG Air
7/16" to 1-1/2" Bore**

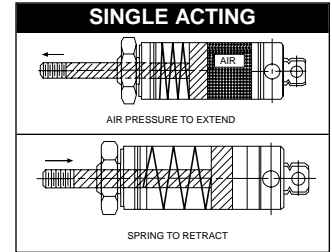

ORDER BY CATALOG NUMBER OR ITEM CODE

Bore	Stroke	Boston Gear Catalog Number	Item Code
7/16	1/2	E25-04NX1-1004	71108
	1	E25-04NX1-1010	71109
	1 1/2	E25-04NX1-1014	71110
	2	E25-04NX1-1020	71111
	3	E25-04NX1-1030	71112
	4	E25-04NX1-1040	71113
9/16	1/2	E25-06NX1-1004	71182
	1	E25-06NX1-1010	71183
	1 1/2	E25-06NX1-1014	71184
	2	E25-06NX1-1020	71185
	3	E25-06NX1-1030	71186
	4	E25-06NX1-1040	71187
3/4	1/2	E25-08NX1-1004	71327
	1	E25-08NX1-1010	71328
	1 1/2	E25-08NX1-1014	71329
	2	E25-08NX1-1020	71330
	3	E25-08NX1-1030	71332
	4	E25-08NX1-1040	71335

ORDER BY CATALOG NUMBER OR ITEM CODE

Bore	Stroke	Boston Gear Catalog Number	Item Code
1 1/16	1	E25-10NX1-1010	71525
	2	E25-10NX1-1020	71526
	3	E25-10NX1-1030	71527
	4	E25-10NX1-1040	71528
1 1/4	1	E25-12NX1-1010	71613
	2	E25-12NX1-1020	71616
	3	E25-12NX1-1030	71627
1 1/2	1	E25-15NX1-1010	71753
	2	E25-15NX1-1020	71754
	3	E25-15NX1-1030	71755
	4	E25-15NX1-1040	71756

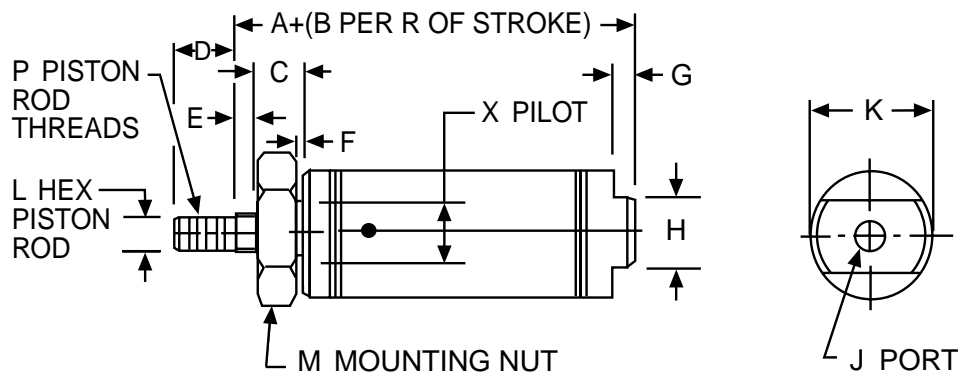

ALL DIMENSIONS IN INCHES

Bore	A	B	C	D	E	F	G	H	J	K	L	M	P	R	X
7/16	1.56	.94	.31	.50	.25	.05	.19	.38	10-32	.50	.18	3/8-24	10-32	1.00	.369/.373
9/16	1.78	1.62	.38	.50	.25	.06	.19	.50	10-32	.62	.18	7/16-20	10-32	1.00	.434/.437
3/4	1.75	1.69	.44	.50	.25	.08	.19	.62	1/8 NPT	.81	.25	1/2-20	1/4-28	1.00	.494/.498
1 1/16	2.19	1.56	.50	.50	.25	.07	.19	.88	1/8 NPT	1.12	.38	5/8-18	5/16-24	1.00	.621/.624
1 1/4	2.66	1.81	.63	.88	.25	.09	.25	.88	1/8 NPT	1.34	.43	3/4-16	7/16-20	1.00	.746/.749
1 1/2	2.44	1.69	.63	.88	.25	.09	.25	.88	1/8 NPT	1.56	.43	3/4-16	7/16-20	1.00	.746/.749

See page 27 for Force Factors and Spring Forces

DISPOSABLE CYLINDERS

PC – Reverse Single Acting, Pivot Mount

E25 Series
250 PSIG Air
7/16" to 2" Bore

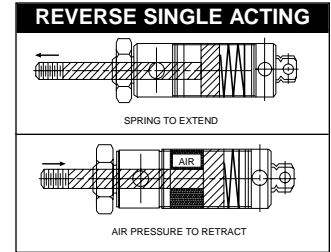

ORDER BY CATALOG NUMBER OR ITEM CODE

Bore	Stroke	Boston Gear Catalog Number	Item Code
7/16	1/2	E25-04PC1-1004	71126
	1	E25-04PC1-1010	71127
	1 1/2	E25-04PC1-1014	71128
	2	E25-04PC1-1020	71129
	3	E25-04PC1-1030	71130
	4	E25-04PC1-1040	71131
9/16	1/2	E25-06PC1-1004	71200
	1	E25-06PC1-1010	71201
	1 1/2	E25-06PC1-1014	71202
	2	E25-06PC1-1020	71203
	3	E25-06PC1-1030	71204
	4	E25-06PC1-1040	71205
3/4	1/2	E25-08PC1-1004	71358
	1	E25-08PC1-1010	71361
	1 1/2	E25-08PC1-1014	71364
	2	E25-08PC1-1020	71367
	3	E25-08PC1-1030	71368
	4	E25-08PC1-1040	71373
1 1/16	1	E25-10PC1-1010	71550
	2	E25-10PC1-1020	71551
	3	E25-10PC1-1030	71553
	4	E25-10PC1-1040	71554

ORDER BY CATALOG NUMBER OR ITEM CODE

Bore	Stroke	Boston Gear Catalog Number	Item Code
1 1/4	1	E25-12PC1-1010	71648
	2	E25-12PC1-1020	71651
	3	E25-12PC1-1030	71663
	4	E25-12PC1-1040	71675
1 1/2	1	E25-15PC1-1010	71768
	2	E25-15PC1-1020	71769
	3	E25-15PC1-1030	71770
	4	E25-15PC1-1040	71773
2	1	E25-20PC1-1010	73014
	2	E25-20PC1-1020	73015
	3	E25-20PC1-1030	73016
	4	E25-20PC1-1040	73017

2" BORE ONLY	
STROKE	A + (B Per R of Stroke)
1	8.05
2	11.05
3	13.28
4	17.28

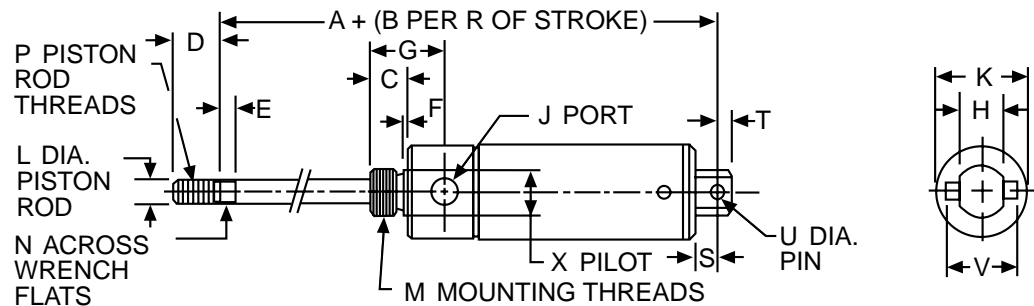

ALL DIMENSIONS IN INCHES

Bore	A	B	C	D	E	F	G	H	J	K	L	M	N	P	R	S	T	U	V	X
7/16	2.38	1.44	.38	.50	—	.05	.72	.31	10-32	.74	.19	7/16-20	—	10-32	.50	.25	.25	.156	.50	.434/.437
9/16	2.28	2.62	.38	.50	—	.06	.75	.31	10-32	.62	.19	7/16-20	—	10-32	1.00	.25	.19	.156	.50	.434/.437
3/4	2.44	2.69	.50	.50	—	.09	.97	.38	1/8 NPT	.86	.25	5/8-18	—	1/4-28	1.00	.34	.28	.250	.75	.621/.624
1 1/16	2.78	2.81	.50	.50	.12	.09	1.06	.38	1/8 NPT	1.12	.31	5/8-18	.25	5/16-24	1.00	.34	.28	.250	.75	.621/.624
1 1/4	3.78	2.81	.63	.75	.25	.09	1.37	.50	1/8 NPT	1.34	.44	3/4-16	.38	7/16-20	1.00	.34	.38	.250	1.34	.746/.749
1 1/2	3.88	3.00	.63	1.25	.25	.09	1.25	.62	1/8 NPT	1.56	.44	3/4-16	.38	7/16-20	1.00	.50	.38	.375	1.00	.746/.749
2	*	*	.81	.88	.38	.12	1.46	.75	1/4 NPT	2.08	.62	1 1/4-12	.50	1/2-20	*	.56	.44	.375	1.63	1.372/1.375

*See chart above.

BOSTON GEAR®

See page 27 for Force Factors and Spring Forces

DISPOSABLE CYLINDERS

PX - Reverse Single Acting, Nose Mount

E25 Series
250 PSIG Air
7/16" to 2" Bore

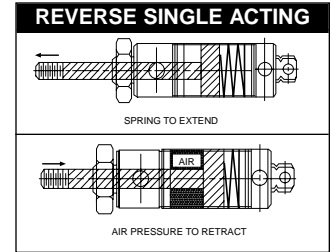

ORDER BY CATALOG NUMBER OR ITEM CODE

Bore	Stroke	Boston Gear Catalog Number	Item Code
7/16	1/2	E25-04PX1-1004	71120
	1	E25-04PX1-1010	71121
	1 1/2	E25-04PX1-1014	71122
	2	E25-04PX1-1020	71123
	3	E25-04PX1-1030	71124
9/16	1/2	E25-06PX1-1004	71194
	1	E25-06PX1-1010	71195
	1 1/2	E25-06PX1-1014	71196
	2	E25-06PX1-1020	71197
	3	E25-06PX1-1030	71198
3/4	1/2	E25-08PX1-1004	71347
	1	E25-08PX1-1010	71348
	1 1/2	E25-08PX1-1014	71349
	2	E25-08PX1-1020	71350
	3	E25-08PX1-1030	71352
1 1/16	1	E25-10PX1-1010	71546
	2	E25-10PX1-1020	71547
	3	E25-10PX1-1030	71548
	4	E25-10PX1-1040	71549

ORDER BY CATALOG NUMBER OR ITEM CODE

Bore	Stroke	Boston Gear Catalog Number	Item Code
1 1/4	1	E25-12PX1-1010	71643
	2	E25-12PX1-1020	71645
	3	E25-12PX1-1030	71646
	4	E25-12PX1-1040	71647
1 1/2	1	E25-15PX1-1010	71762
	2	E25-15PX1-1020	71763
	3	E25-15PX1-1030	71765
2	1	E25-20PX1-1010	73010
	2	E25-20PX1-1020	73011
	3	E25-20PX1-1030	73012
	4	E25-20PX1-1040	73013

2" BORE ONLY	
STROKE	A + (B Per R of Stroke)
1	7.11
2	10.11
3	12.34
4	16.34

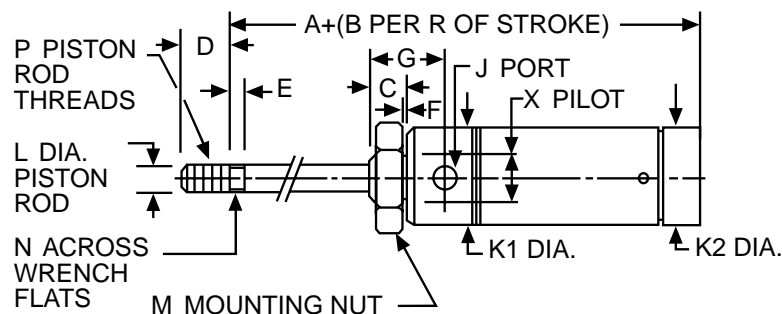

ALL DIMENSIONS IN INCHES

Bore	A	B	C	D	E	F	G	J	K1	K2	L	M	N	P	R	X
7/16	1.94	1.44	.38	.50	—	.05	.72	10-32	.74	.50	.19	7/16-20	—	10-32	.50	.434/.437
9/16	2.00	.262	.38	.50	—	.06	.75	10-32	.62	.62	.19	7/16-20	—	10-32	1.00	.434/.437
3/4	2.31	2.69	.50	.50	—	.09	.97	1/8 NPT	.86	.81	.25	5/8-18	—	1/4-28	1.00	.621/.624
1 1/16	2.62	2.81	.50	.50	.12	.09	1.06	1/8 NPT	1.12	1.12	.31	5/8-18	.25	5/16-24	1.00	.621/.624
1 1/4	3.47	2.81	.63	.75	.25	.09	1.37	1/8 NPT	1.34	1.34	.44	3/4-16	.38	7/16-20	1.00	.746/.749
1 1/2	3.19	3.00	.63	1.25	.25	.09	1.25	1/8 NPT	1.56	1.56	.44	3/4-16	.38	7/16-20	1.00	.746/.749
2	*	*	.81	.88	.38	.12	1.46	1/4 NPT	2.08	2.08	.62	1 1/4-12	.50	1/2-20	*	1.372/1.375

*See chart above.

See page 27 for Force Factors and Spring Forces

BOSTON GEAR®

Fluid Power Catalog

DISPOSABLE CYLINDERS

SC - Single Acting, Pivot Mount

E25 Series
250 PSIG Air
7/16" to 2" Bore

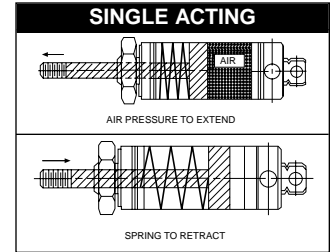

ORDER BY CATALOG NUMBER OR ITEM CODE

Bore	Stroke	Boston Gear Catalog Number	Item Code
7/16	1/2	E25-04SC1-1004	71102
	1	E25-04SC1-1010	71103
	1 1/2	E25-04SC1-1014	71104
	2	E25-04SC1-1020	71105
	3	E25-04SC1-1030	71106
	4	E25-04SC1-1040	71107
9/16	1/2	E25-06SC1-1004	71176
	1	E25-06SC1-1010	71177
	1 1/2	E25-06SC1-1014	71178
	2	E25-06SC1-1020	71179
	3	E25-06SC1-1030	71180
	4	E25-06SC1-1040	71181
3/4	1/2	E25-08SC1-1004	71253
	1	E25-08SC1-1010	71263
	1 1/2	E25-08SC1-1014	71264
	2	E25-08SC1-1020	71265
	3	E25-08SC1-1030	71321
	4	E25-08SC1-1040	71326

ORDER BY CATALOG NUMBER OR ITEM CODE

Bore	Stroke	Boston Gear Catalog Number	Item Code
1 1/16	1	E25-10SC1-1010	71521
	2	E25-10SC1-1020	71522
	3	E25-10SC1-1030	71523
	4	E25-10SC1-1040	71524
1 1/4	1	E25-12SC1-1010	71591
	2	E25-12SC1-1020	71592
	3	E25-12SC1-1030	71593
	4	E25-12SC1-1040	71611
1 1/2	1	E25-15SC1-1010	71741
	2	E25-15SC1-1020	71743
	3	E25-15SC1-1030	71745
	4	E25-15SC1-1040	71752
2	1	E25-20SC1-1010	73006
	2	E25-20SC1-1020	73007
	3	E25-20SC1-1030	73008
	4	E25-20SC1-1040	73009

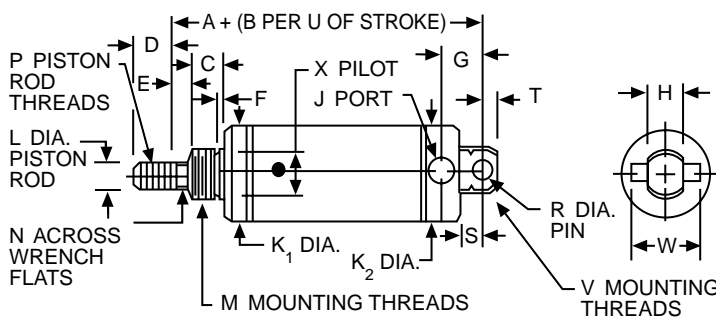

2" BORE ONLY	
STROKE	A + (B Per U of Stroke)
1	6.34
2	8.34
3	9.59
4	12.53

ALL DIMENSIONS IN INCHES

Bore	A	B	C	D	E	F	G	H	J	K1	K2	L	M	N	P	R	S	T	U	V	W	X
7/16	1.75	.94	.31	.50	—	.05	.44	.31	10-32	.50	.74	.18	3/8-24	—	10-32	.156	.25	.25	.50	7/16-20	.50	.369/.373
9/16	1.81	1.62	.38	.50	—	.06	.38	.31	10-32	.62	.62	.18	7/16-20	—	10-32	.156	.25	.19	1.00	7/16-20	.50	.434/.437
3/4	2.28	1.69	.44	.50	—	.08	.62	.38	1/8 NPT	.81	.86	.25	1/2-20	—	1/4-28	.250	.34	.28	1.00	5/8-18	.75	.494/.498
1 1/16	2.66	1.56	.50	.50	.12	.07	.62	.38	1/8 NPT	1.12	1.12	.31	5/8-18	.25	5/16-24	.250	.34	.28	1.00	5/8-18	.75	.621/.624
1 1/4	3.38	1.81	.63	.75	.25	.09	.78	.50	1/8 NPT	1.34	1.34	.43	3/4-16	.38	7/16-20	.250	.41	.40	1.00	3/4-16	.88	.746/.749
1 1/2	3.12	1.69	.63	.75	.25	.09	.81	.62	1/8 NPT	1.56	1.56	.43	3/4-16	.38	7/16-20	.375	.50	.38	1.00	—	1.00	.746/.749
2	*	*	.81	.88	.38	.12	1.03	.75	1/4 NPT	2.08	2.08	.62	1-1/4-12	.50	1/2-20	.375	.56	.44	*	1-1/4-12	1.63	1.372/1.375

*See chart above.

See page 27 for Force Factors and Spring Forces

DISPOSABLE CYLINDERS

SX - Single Acting, Nose Mount

E25 Series
250 PSIG Air
7/16" to 2" Bore

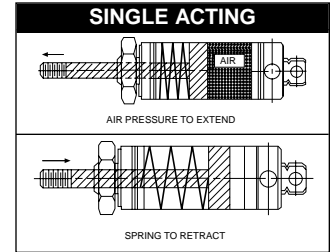

ORDER BY CATALOG NUMBER OR ITEM CODE

Bore	Stroke	Boston Gear Catalog Number	Item Code
7/16	1/2	E25-04SX1-1004	71096
	1	E25-04SX1-1010	71097
	1 1/2	E25-04SX1-1014	71098
	2	E25-04SX1-1020	71099
	3	E25-04SX1-1030	71100
9/16	1/2	E25-06SX1-1004	71170
	1	E25-06SX1-1010	71171
	1 1/2	E25-06SX1-1014	71172
	2	E25-06SX1-1020	71173
	3	E25-06SX1-1030	71174
3/4	1/2	E25-08SX1-1004	71245
	1	E25-08SX1-1010	71246
	1 1/2	E25-08SX1-1014	71247
	2	E25-08SX1-1020	71250
	3	E25-08SX1-1030	71251
1 1/16	1	E25-10SX1-1010	71512
	2	E25-10SX1-1020	71513
	3	E25-10SX1-1030	71518
	4	E25-10SX1-1040	71519

ORDER BY CATALOG NUMBER OR ITEM CODE

Bore	Stroke	Boston Gear Catalog Number	Item Code
1 1/4	1	E25-12SX1-1010	71587
	2	E25-12SX1-1020	71588
	3	E25-12SX1-1030	71589
	4	E25-12SX1-1040	71590
1 1/2	1	E25-15SX1-1010	71715
	2	E25-15SX1-1020	71720
	3	E25-15SX1-1030	71727
2	1	E25-20SX1-1010	71936
	2	E25-20SX1-1020	73003
	3	E25-20SX1-1030	73004
	4	E25-20SX1-1040	73005

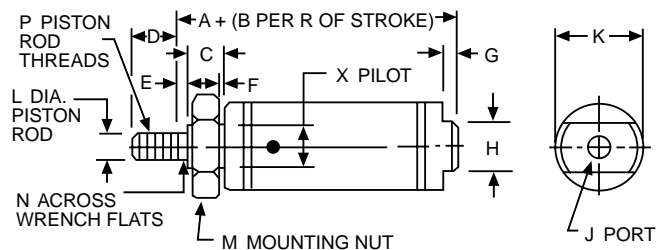

ALL DIMENSIONS IN INCHES

Bore	A	B	C	D	E	F	G	H	J	K	L	M	N	P	R	X
7/16	1.31	.94	.31	.50	—	.05	.19	.38	10-32	.50	.18	3/8-24	—	10-32	.50	.369/.373
9/16	1.53	1.62	.38	.50	—	.06	.19	.50	10-32	.62	.18	7/16-20	—	10-32	1.00	.434/.437
3/4	1.50	1.69	.44	.50	—	.08	.19	.62	1/8 NPT	.81	.25	1/2-20	—	1/4-28	1.00	.494/.498
1 1/16	1.94	1.56	.50	.50	—	.07	.19	.88	1/8 NPT	1.12	.31	5/8-18	—	5/16-24	1.00	.621/.624
1 1/4	2.66	1.81	.63	.75	.25	.09	.25	.88	1/8 NPT	1.34	.43	3/4-16	.38	7/16-20	1.00	.746/.749
1 1/2	2.44	1.69	.63	.75	.25	.09	.25	.88	1/8 NPT	1.56	.43	3/4-16	.38	7/16-20	1.00	.746/.749
2	*	*	.81	.88	.38	.12	.31	1.25	1/4 NPT	2.08	.62	1-1/4-12	.50	1/2-20	*	1.372/1.375

2" BORE ONLY	
STROKE	A + (B Per R of Stroke)
1	5.41
2	7.41
3	8.66
4	11.59

*See chart on right.

See page 27 for Force Factors and Spring Forces

DISPOSABLE CYLINDERS

Competitive Cross-Reference Guide

Boston Gear's E25 Series of disposable cylinders are designed to be functionally and dimensionally interchangeable with these and many other manufacturers cylinders. This chart is intended to be a guide only. Please see the appropriate manufacturer's catalogs for exact details regarding specifications and dimensions.

□ = manufacturer's stroke length designation

Bore	CYLINDER MODEL AND MOUNTING STYLE		MANUFACTURER						
			BOSTON GEAR Catalog No.	C&C Model No.	Bimba Model No.	Clippard Model No.	American Model No.	Humphrey Model No.	Parker Model No.
7/16"	Single Acting	- Nose	E25-04SX1-1□□□	RLA□□□-SAN-AA00	01□	N/A	437SNS-□	N/A	.44NSR□
		- Pivot	E25-04SC1-1□□□	RLA□□□-SAP-AA00	01□-P		437SVS-□		.44PSR□
	Single Acting Non-Rotating	- Nose	E25-04NX1-1□□□	RLA□□□-NRN-AA00	01□-NR		437SNHS-□		.44NRSR□
		- Pivot	E25-04NC1-1□□□	RLA□□□-NRP-AA00	01□-NRP		437RVHS-□		.44NRPSR□
	Reverse Single Acting	- Nose	E25-04PX1-1□□□	RLA□□□-RAN-AA00	01□-R		437RNS-□		.44RSR□
		- Pivot	E25-04PC1-1□□□	RLA□□□-RAP-AA00	01□-RP		437RVS-□		.44RPSR□
	Double Acting	- Nose	E25-04DX1-1□□□	RLA□□□-DAN-AA00	01□-D		437DNS-□		.44DSR□
		- Pivot	E25-04DC1-1□□□	RLA□□□-DAP-AA00	01□-DP		437DVS-□		.44DPSR□
	- Double End	E25-04DS1-1□□□	RLA□□□-DAD-AA00	01□-DX	437DVS-□-2		.44DXPSR□		
	Double Acting Double Rod End	- Double End	E25-04DR1-1□□□	RLA□□□-DRD-AA00	01□-DXDE		437DES-□		.44KDXSR□
9/16"	Single Acting	- Nose	E25-06SX1-1□□□	RLB□□□-SAN-AA00	02□	N/A	562SNS-□	N/A	.56NSR□
		- Pivot	E25-06SC1-1□□□	RLB□□□-SAP-AA00	02□-P		562SVS-□		.56PSR□
	Single Acting Non-Rotating	- Nose	E25-06NX1-1□□□	RLB□□□-NRN-AA00	02□-NR		562SNHS-□		.56NRSR□
		- Pivot	E25-06NC1-1□□□	RLB□□□-NRP-AA00	02□-NRP		562SVHS-□		.56NRPSR□
	Reverse Single Acting	- Nose	E25-06PX1-1□□□	RLB□□□-RAN-AA00	02□-R		562RNS-□		.56RSR□
		- Pivot	E25-06PC1-1□□□	RLB□□□-RAP-AA00	02□-RP		562RVS-□		.56RPSR□
	Double Acting	- Nose	E25-06DX1-1□□□	RLB□□□-DAN-AA00	02□-D		562DNS-□		.56DSR□
		- Pivot	E25-06DC1-1□□□	RLB□□□-DAP-AA00	02□-DXP		562DVS-□		.56DXPSR□
	- Double End	E25-06DS1-1□□□	RLB□□□-DAD-AA00	02□-DXP	562DVS-□-2		.56DXPSR□		
	Double Acting Double Rod End	- Double End	E25-06DR1-1□□□	RLB□□□-DRD-AA00	02□-DXDE		562DES-□		.56KDXSR□
3/4"	Single Acting	- Nose	E25-08SX1-1□□□	RLC□□□-SAN-AA00	04□	SSR-12-□	750SNS-□	7-S-□	.75NSR□
		- Pivot	E25-08SC1-1□□□	RLC□□□-SAP-AA00	04□-P	USR-12-□	750SVS-□	7-SP-□	.75PSR□
	Single Acting Non-Rotating	- Nose	E25-08NX1-1□□□	RLC□□□-NRN-AA00	04□-NR	SSN-12-□	750SNHS-□	7-SH-□	.75NRSR□
		- Pivot	E25-08NC1-1□□□	RLC□□□-NRP-AA00	04□-NRP	USN-12-□	750SVHS-□	7-SHP-□	.75NRPSR□
	Reverse Single Acting	- Nose	E25-08PX1-1□□□	RLC□□□-RAN-AA00	04□-R	SSR-12-□	750RNS-□	7-SR-□	.75RSR□
		- Pivot	E25-08PC1-1□□□	RLC□□□-RAP-AA00	04□-RP	URR-12-□	750RVS-□	7-SRP-□	.75RPSR□
	Double Acting	- Nose	E25-08DX1-1□□□	RLC□□□-DAN-AA00	04□-D	SDR-12-□	750DNS-□	7-D-□	.75DSR□
		- Pivot	E25-08DC1-1□□□	RLC□□□-DAP-AA00	04□-DP	UDR-12-□	750DVS-□	7-DP-□	.75DPSR□
	- Double End	E25-08DS1-1□□□	RLC□□□-DAD-AA00	04□-DX	UDR-12-□	750DVS-□-2	7-DP-□	.75DXPSR□	
	Double Acting Double Rod End	- Double End	E25-08DR1-1□□□	RLC□□□-DRD-AA00	04□-DXDE	SDD-12-□	750DES-□	7-D2EY-□	.75KDXSR□

DISPOSABLE CYLINDERS

Competitive Cross-Reference Guide

□ = manufacturer's stroke length designation

Bore	CYLINDER MODEL AND MOUNTING STYLE		MANUFACTURER						
			BOSTON GEAR Catalog No.	C&C Model No.	Bimba Model No.	Clippard Model No.	American Model No.	Humphrey Model No.	Parker Model No.
1 1/16"	Single Acting	- Nose - Pivot	E25-10SX1-1□□□ E25-10SC1-1□□□	RLD□□□-SAN-AA00 RLD□□□-SAP-AA00	09□ 09□-P	SSR-17-□ USR-17-□	1062SNS-□ 1062SVS-□	6-S-□ 6-SP-□	1.06NSR□ 1.06PSR□
	Single Acting Non-Rotating	- Nose - Pivot	E25-10NX1-1□□□ E25-10NC1-1□□□	RLD□□□-NRN-AA00 RLD□□□-NRP-AA00	09□-NR 09□-NRP	SSN-17-□ USN-17-□	1062SNHS-□ 1062SVHS-□	6-SH-□ 6-SHP-□	1.06NRSR□ 1.06NRPSR□
	Reverse Single Acting	- Nose - Pivot	E25-10PX1-1□□□ E25-10PC1-1□□□	RLD□□□-RAN-AA00 RLD□□□-RAP-AA00	09□-R 09□-RP	SSR-17-□ URR-17-□	1062RNS-□ 1062RVS-□	6-SR-□ 6-SRP-□	1.06RSR□ 1.06RPSR□
	Double Acting	- Nose - Pivot	E25-10DX1-1□□□ E25-10DC1-1□□□	RLD□□□-DAN-AA00 RLD□□□-DAP-AA00	09□-D 09□-DP	SDR-17-□ UDR-17-□	1062DNS-□ 1062DVS-□	6-D-□ 6-DP-□	1.06DSR□ 1.06DPSR□
	Double Acting Double Rod End	- Double End	E25-10DS1-1□□□ E25-10DR1-1□□□	RLD□□□-DAD-AA00 RLD□□□-DRD-AA00	09□-DX 09□-DXDE	UDR-17-□ SDD-17-□	1062DVS-□-2 1062DES-□	6-DP-□ 6-D2EY-□	1.06DXPSR□ 1.06KDXSR□
1 1/4"	Single Acting	- Nose - Pivot	E25-12SX1-1□□□ E25-12SC1-1□□□	RLF□□□-SAN-AA00 RLF□□□-SAP-AA00	12□ 12□-P	SSR-20-□ USR-20-□	1250SNS-□ 1250SVS-□	25-S-□ 25-SP-□	1.25NSR□ 1.25PSR□
	Single Acting Non-Rotating	- Nose - Pivot	E25-12NX1-1□□□ E25-12NC1-1□□□	RLF□□□-NRN-AA00 RLF□□□-NRP-AA00	12□-NR 12□-NRP	SSN-20-□ USN-20-□	1250SNHS-□ 1250SVHS-□	25-SH-□ 25-SHP-□	1.25NRSR□ 1.25NRPSR□
	Reverse Single Acting	- Nose - Pivot	E25-12PX1-1□□□ E25-12PC1-1□□□	RLF□□□-RAN-AA00 RLF□□□-RAP-AA00	12□-R 12□-RP	SRR-20-□ URR-20-□	1250RNS-□ 1250RVS-□	25-SR-□ 25-SRP-□	1.25RSR□ 1.25RPSR□
	Double Acting	- Nose - Pivot - Double End	E25-12DX1-1□□□ E25-12DC1-1□□□ E25-12DS1-1□□□	RLF□□□-DAN-AA00 RLF□□□-DAP-AA00 RLF□□□-DAD-AA00	12□-D 12□-DP 12□-DP	SDR-20-□ UDR-20-□ UDR-20-□	1250DNS-□ 1250DVS-□ 1250DVS-□-2	25-D-□ 25-DP-□ 25-DP-□	1.25DSR□ 1.25DXPSR□ 1.25DXPSR□
	Double Acting Double Rod End	- Double End	E25-12DR1-1□□□	RLF□□□-DRD-AA00	12□-DXDE	SDD-20-□	1250DES-□	25-D2EY-□	1.25KDXSR□
1 1/2"	Single Acting	- Nose - Pivot	E25-15SX1-1□□□ E25-15SC1-1□□□	RLF□□□-SAN-AA00 RLF□□□-SAP-AA00	17□ 17□-P	SSR-24-□ CSR-24-□	1500SNS-□ 1500SVS-□	5-S-□ 5-SP-□	1.50NSR□ 1.50PSR□
	Single Acting Non-Rotating	- Nose - Pivot	E25-15NX1-1□□□ E25-15NC1-1□□□	RLF□□□-NRN-AA00 RLF□□□-NRP-AA00	17□-NR 17□-NRP	SSN-24-□ CSN-24-□	1500SNHS-□ 1500SVHS-□	5-SH-□ 5-SHP-□	1.50NRSR□ 1.50NRPSR□
	Reverse Single Acting	- Nose - Pivot	E25-15PX1-1□□□ E25-15PC1-1□□□	RLF□□□-RAN-AA00 RLF□□□-RAP-AA00	17□-R 17□-RP	SRR-24-□ CRR-24-□	1500RNS-□ 1500RVS-□	5-SR-□ 5-SRP-□	1.50RSR□ 1.50RPSR□
	Double Acting	- Nose - Pivot - Double End	E25-15DX1-1□□□ E25-15DC1-1□□□ E25-15DS1-1□□□	RLF□□□-DAN-AA00 RLF□□□-DAP-AA00 RLF□□□-DAD-AA00	17□-D 17□-DP 17□-DX	SDR-24-□ CDR-24-□ EDR-24-□	1500DNS-□ 1500DVS-□ 1500DVS-□-2	5-D-□ 5-DP-□ 5-DP-□	1.50DSR□ 1.50DPSR□ 1.50DXSR□
	Double Acting Double Rod End	- Double End	E25-15DR1-1□□□	RLF□□□-DRD-AA00	17□-DXDE	SDD-24-□	1500DES-□	5-D2EY-□	1.50KDXSR□
2"	Single Acting	- Nose - Pivot	E25-20SX1-1□□□ E25-20SC1-1□□□	RLG□□□-SAN-AA00 RLG□□□-SAP-AA00	31□ 31□-XP	N/A	N/A	4-S-□ 4-SP-□	2.00NSR□ 2.00PSR□
	Reverse Single Acting	- Nose - Pivot	E25-20PX1-1□□□ E25-20PC1-1□□□	RLG□□□-RAN-AA00 RLG□□□-RAP-AA00	31□-R 31□-RP			4-SR-□ 4-SRP-□	2.00RSR□ 2.00RPSR□
	Double Acting	- Nose - Pivot - Double End	E25-20DX1-1□□□ E25-20DC1-1□□□ E25-20DS1-1□□□	RLG□□□-DAN-AA00 RLG□□□-DAP-AA00 RLG□□□-DAD-AA00	31□-D 31□-DXP 31□-DXP	SDR-32-□ UDR-32-□ UDR-32-□		4-D-□ 4-DP-□ 4-DP-□	2.00DSR□ 2.00DXPSR□ 2.00DXPSR□
	Double Acting Double Rod End	- Double End	E25-20DR1-1□□□	RLG□□□-DRD-AA00	31□-DXDE	N/A		2000DES-□	4-D2EY-□
2 1/2"	Double Acting	- Nose - Pivot - Double End	E25-25DX1-1□□□ E25-25DC1-1□□□ E25-25DS1-1□□□	RLH□□□-DAN-AA00 RLH□□□-DAP-AA00 RLH□□□-DAD-AA00	50□-D 50□-DXP 50□-DXP	N/A UDR-40-□ UDR-40-□	N/A	3-D-□ 3-DP-□ 3-DP-□	N/A
	Double Acting Double Rod End	- Double End	E25-25DR1-1□□□	RLH□□□-DRD-AA00	50□-DXDE	N/A		3-D2EY-□	

DISPOSABLE CYLINDERS

Mounting Accessories

E25 Series

Note: All accessories are bright zinc plated.

SELECTION CHART

Bore	Style & Mounting	Nose Thread	Mounting Nut		Rod Clevis		Pivot Bracket		Foot Bracket	
			Catalog Number	Item Number	Catalog Number	Item Number	Catalog Number	Item Number	Catalog Number	Item Number
7/16	SX, SC, NX, NC	3/8-24	FMN-06	71153	FCV-03-1032	74368	CVB-025	74373	FMB-06	73382
	PX, PC, DX, DC, DS, DR	7/16-20	FMN-07	71154	FCV-03-1032	74368	CVB-025	74373	FMB-07	73383
9/16	ALL	7/16-20	FMN-07	71154	FCV-03-1032	74368	CVB-025	74373	FMB-07	73383
3/4	SX, SC, NX, NC	1/2-20	FMN-08	71155	FCV-04-0428	74369	CVB-04	74374	FMB-08	73384
	PX, PC, DX, DC, DS, DR	5/8-18	FMN-10	73104	FCV-04-0428	74369	CVB-04	74374	FMB-10	73385
1 1/16	ALL	5/8-18	FMN-10	73104	FCV-04-0524	74370	CVB-04	74374	FMB-10	73385
1 1/4	ALL	3/4-16	FMN-12	73105	FCV-06-0720	74371	CVB-04	74374	FMB-12	73386
1 1/2	ALL	3/4-16	FMN-12	73105	FCV-06-0720	74371	CVB-06A	74375	FMB-12	73386
2	ALL	1 1/4-12	FMN-22	73106	FCV-06-0820	74372	CVB-06B	74376	FMB-22	73387
2 1/2	ALL	1 3/8-12	FMN-24	73107	FCV-06-0820	74372	CVB-06B	74376	FMB-24	71152

ROD CLEVIS

(includes pin & jam nut)

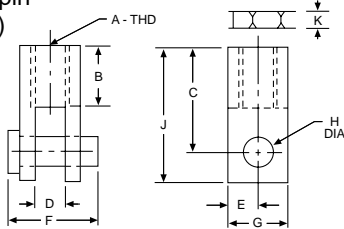

ALL DIMENSIONS IN INCHES

Catalog Number	Item Code	A	B	C	D	E	F	G	H	J	K
FCV-03-1032	74368	10-32	.38	.75	.19	.19	.66	.38	.19	.94	.12
FCV-04-0428	74369	1/4-28	.50	.94	.25	.25	.85	.50	.25	1.19	.16
FCV-04-0524	74370	5/16-24	.50	.94	.25	.25	.85	.50	.25	1.19	.19
FCV-06-0720	74371	7/16-20	.75	1.31	.38	.38	1.12	.75	.38	1.69	.25
FCV-06-0820	74372	1/2-20	.75	1.31	.38	.38	1.12	.75	.38	1.69	.31

PIVOT BRACKET (PAIR)

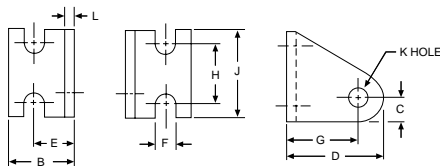

Catalog Number	Item Code	B	C	D	E	F	G	H	J	K	L
CVB-025	74373	.50	.20	.77	.28	.19	.56	.50	.75	.156	.06
CVB-04	74374	.81	.31	1.19	.44	.27	.88	.75	1.12	.250	.12
CVB-06A	74375	1.00	.38	1.75	.62	.27	1.38	1.00	1.50	.375	.12
CVB-06B	74376	1.125	.38	1.75	.68	.27	1.38	1.00	1.50	.375	.25

FOOT BRACKET

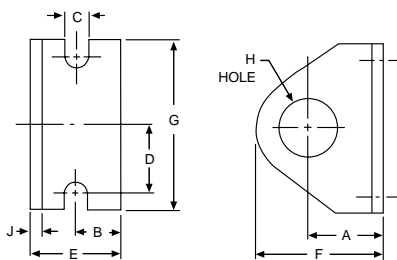

Catalog Number	Item Code	A	B	C	D	E	F	G	H	J
FMB-06	73382	.56	.22	.19	.50	.52	.88	1.38	.38	.07
FMB-07	73383	.56	.31	.19	.50	.69	.94	1.38	.44	.09
FMB-08	73384	.69	.31	.19	.62	.75	1.09	1.62	.50	.10
FMB-10	73385	.81	.44	.27	.75	1.00	1.38	1.88	.62	.12
FMB-12	73386	1.00	.75	.28	.94	1.50	1.75	2.50	.75	.12
FMB-22	73387	1.50	.62	.34	1.12	1.62	2.50	3.12	1.38	.25
FMB-24	71152	1.75	.62	.34	1.44	1.62	3.00	3.75	1.50	.25

MOUNTING NUT

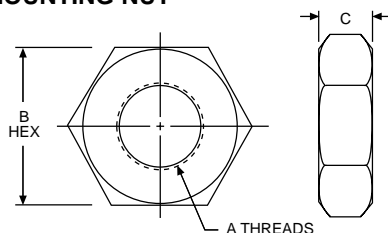

Catalog Number	Item Code	A	B	C
FMN-06	71153	3/8 - 24	.56	.22
FMN-07	71154	7/16 - 20	.69	.25
FMN-08	71155	1/2 - 20	.75	.31
FMN-10	73104	5/8 - 18	.94	.38
FMN-12	73105	3/4 - 16	1.12	.42
FMN-22	73106	1 1/4 - 12	1.88	.50
FMN-24	73107	1 3/8 - 12	2.00	.50

TIE-ROD CYLINDERS

**MEDIUM DUTY NFPA/JIC
DOUBLE ACTING
1-1/2 TO 6" BORE**

BE10 Series

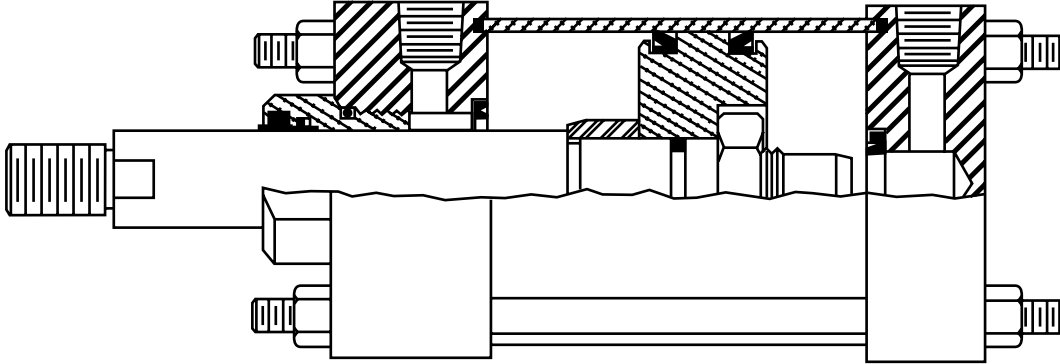

RATINGS PSIG

Air — 250 PSI

Oil — 500 PSI (Non-shock)

FEATURES

INDUSTRY INTERCHANGEABLE — Meets NFPA/JIC dimensional standards.

FIXED (Non-adjustable) CUSHIONS supplied on head and cap end — standard.
Adjustable cushions available.

REMOVABLE ROD BEARING — Piloted by the head to provide positive alignment to the tube. It can be removed without disturbing the tie rods.

ROD WIPER and ROD SEAL CONTAINED IN ROD BEARING — For easy accessibility.

PISTON ROD — 100,000 psi minimum yield, steel hard chrome plated and polished smooth to extend the life of the seals and rod bearing.

TUBING IS HARD ANODIZED on I.D. and O.D. — Honed for minimum friction and long life.

HEAD and CAPS — Machined from precision steel blocks to insure concentricity of piston rod to tubing and to mounting surfaces.

PISTON — Aluminum

PISTON SEALS — U-cup seals made of Buna-N for minimum friction and positive sealing.

TIE RODS — 100,000 psi minimum yield material with rolled threads for added strength.

TIE-ROD CYLINDERS

DOUBLE ACTING

BE10 Series

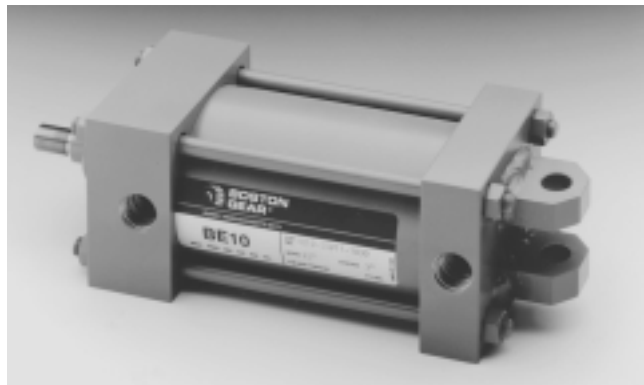

HOW TO ORDER BE10 SERIES CYLINDERS

To develop a Cylinder Order Number, select only those Code Numbers that represent the cylinder required, and place in the sequence shown below:

EXAMPLE: Required Cylinder — Medium Duty Air Cylinder, 4" Bore, Detachable Clevis (NFPA Mounting—MP2), Standard Rod, Adjustable Cushion Head End, Standard Port location, 73" of Stroke, 1" Standard Rod Diameter, 1-14 Full Diameter Rod Threads.

SPECIFY

Series	Code No.	Bore Dia.	Code No.	Mounting	NFPA Des.	Code No.	Cushions and Rod	Code No.	Port Positions**	Stroke in Code No.	Whole Inches	Fractional Code No.	Stroke Length	Code No.	Modification Descriptions	
BE10 Pneumatic	15	- 1-1/2	BX	- None (Basic Cylinder)	—		Standard Rod Diameter		1 - Standard Port Position	01	- 1 inch	0	- No fraction		- Style 1 Standard Thread (code not required—leave blank)	
	20	- 2	DBX	- Double Rod Basic	—		1 - Non-Adjustable Cushions		2 - 90° Clockwise Port Position	05	- 5	1	- 1/8 inch			
	25	- 2-1/2	F1	- Head Rectangular Flange	MF1		2 - Cushioned Head End		3 - 180° Clockwise Port Position	12	- 12	2	- 1/4			
	32	- 3-1/4	F2	- Cap Rectangular Flange	MF2		3 - Cushioned Cap End		4 - 270° Clockwise Port Position	25	- 25	3	- 3/8			
	40	- 4	F5	- Head Square Flange	MF5		4 - Cushioned Both Ends			30	- 30	4	- 1/2		02 - Style 2 Rod End — Full diameter Male Th'd.	
	50	- 5	F6	- Cap Square Flange	MF6		1st Oversize Rod Diameter			43	- 43	5	- 5/8			
	60	- 6	P1	- Cap Fixed Clevis	MP1		5 - Non-Adjustable Cushions			66	- 66	6	- 3/4			
				P2	- Cap Detachable Clevis	MP2		6 - Cushioned Head End		etc.			7	- 7/8		
				P3	- Cap Fixed Eye	MP3		7 - Cushioned Cap End					9	- For fractions not shown - Specify		03 - Style 3 Rod End — Female Th'd.
				S2	- Side Lugs	MS2		8 - Cushioned Both Ends								04 - Style 4 Rod End — Optional Shoulder, Male Th'd.
				S4	- Side Tapped	MS4		9 - 2nd Oversize Rods and larger-Specify								XX - Special (Specify)
				S7	- Side End Lugs	MS7										
				T1	- Head Trunnion	MT1										
				T2	- Cap Trunnion	MT2										
				T4	- Intermediate Trunnion	MT4										
			X1	- Extended Tie Rods-Both Ends	MX1											
			X2	- Extended Tie Rods-Cap End	MX2											
			X3	- Extended Tie Rods-Head End	MX3											

Add D to mounting for Double Rod ex. DS4

**View facing Rod End.

Rod Dia.	ROD DIAMETERS AVAILABLE						
	Bore Dia.						
	1-1/2	2	2-1/2	3-1/4	4	5	6
5/8	STD	STD	STD	—	—	—	—
1	1st OS†	1st OS	1st OS	STD	STD	STD	—
1-3/8	—	A	A	1st OS	1st OS	1st OS	STD
1-3/4	—	—	A	A	A	A	1st OS
2	—	—	—	A	A	A	A
2-1/2	—	—	—	—	A	A	A
3	—	—	—	—	—	A	A
3-1/2	—	—	—	—	—	A	A
4	—	—	—	—	—	—	A

STD — Standard Rod Diameter; 1st OS — First Oversized Rod Diameter

A — Available Rod Diameters, Consult Factory

† — Adjustable cushion not available on head end, 1-1/2" bore with 1" rod diameter.

TIE-ROD CYLINDERS

**DOUBLE ACTING
BASIC MOUNTING**

**BE10 Series
1-1/2" to 6" Bore**

BX — Basic Mounting

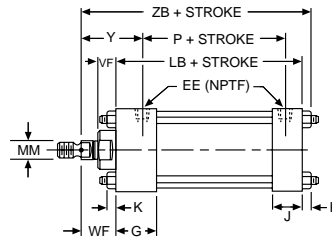
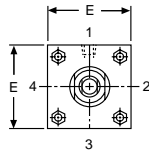

DBX — Double Rod Basic Mounting

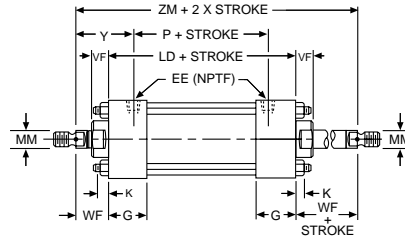
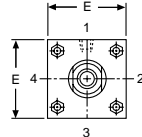

**Style 1
Standard Unless
Otherwise Specified**

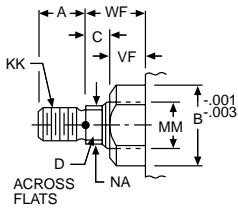

**Style 2
Full Diameter
Male Thread**

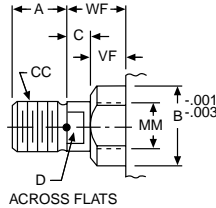

**Style 3
Female Thread**

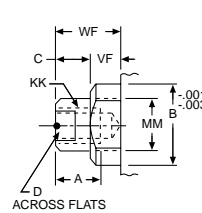

**Style 4
Optional Shouldered
Male Thread**

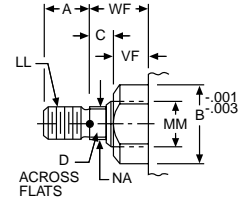

ALL DIMENSIONS IN INCHES

Bore	E	EE (NPTF)	G	J	K	LB	LD	P
1-1/2	2	3/8-18	1-1/2	1	1/4	3-5/8	4-1/8	2-1/4
2	2-1/2	3/8-18	1-1/2	1	5/16	3-5/8	4-1/8	2-1/4
2-1/2	3	3/8-18	1-1/2	1	5/16	3-3/4	4-1/4	2-3/8
3-1/4	3-3/4	1/2-14	1-3/4	1-1/4	3/8	4-1/4	4-3/4	2-5/8
4	4-1/2	1/2-14	1-3/4	1-1/4	3/8	4-1/4	4-3/4	2-5/8
5	5-1/2	1/2-14	1-3/4	1-1/4	7/16	4-1/2	5	2-7/8
6	6-1/2	3/4-14	2	1-1/2	7/16	5	5-1/2	3-1/8

Bore	Rod Dia. (MM)	Thread			A	B	C	D	NA	VF	WF	Y	ZB	ZM
		CC	KK*	LL										
1-1/2	5/8	5/8-18	7/16-20	1/2-20	3/4	1-1/8	3/8	1/2	19/32	5/8	1	1-15/16	4-7/8	6-1/8
	1	1-14	3/4-16	7/8-14	1-1/8	1-1/2	1/2	7/8	31/32	7/8	1-3/8	2-5/16	5-1/4	6-3/8
2	5/8	5/8-18	7/16-20	1/2-20	3/4	1-1/8	3/8	1/2	19/32	5/8	1	1-15/16	4-15/16	6-1/8
	1	1-14	3/4-16	7/8-14	1-1/8	1-1/2	1/2	7/8	31/32	7/8	1-3/8	2-5/16	5-5/16	6-7/8
2-1/2	5/8	5/8-18	7/16-20	1/2-20	3/4	1-1/8	3/8	1/2	19/32	5/8	1	1-15/16	5-1/16	6-1/4
	1	1-14	3/4-16	7/8-14	1-1/8	1-1/2	1/2	7/8	31/32	7/8	1-3/8	2-5/16	5-7/16	7
3-1/4	1	1-14	3/4-16	7/8-14	1-1/8	1-1/2	1/2	7/8	31/32	7/8	1-3/8	2-7/16	6	7-1/2
	1-3/8	1-3/8-12	1-14	1-1/4-12	1-5/8	2	5/8	1-1/8	1-11/32	1	1-5/8	2-11/16	6-1/4	8
4	1	1-14	3/4-16	7/8-14	1-1/8	1-1/2	1/2	7/8	31/32	7/8	1-3/8	2-7/16	6	7-1/2
	1-3/8	1-3/8-12	1-14	1-1/4-12	1-5/8	2	5/8	1-1/8	1-11/32	1	1-5/8	2-11/16	6-1/4	8
5	1	1-14	3/4-16	7/8-14	1-1/8	1-1/2	1/2	7/8	31/32	7/8	1-3/8	2-7/16	6-5/16	7-3/4
	1-3/8	1-3/8-12	1-14	1-1/4-12	1-5/8	2	5/8	1-1/8	1-11/32	1	1-5/8	2-11/16	6-9/16	8-1/4
6	1-3/8	1-3/8-12	1-14	1-1/4-12	1-5/8	2	5/8	1-1/8	1-11/32	1	1-5/8	2-13/16	7-1/16	8-3/4
	1-3/4	1-3/4-12	1-1/4-12	1-1/2-12	2	2-3/8	3/4	1-1/2	1-23/32	1-1/8	1-7/8	3-1/16	7-5/16	9-1/4

*Standard thread — other threads available.

To order, see "How to Order" page 42

BOSTON GEAR®

Fluid Power Catalog

TIE-ROD CYLINDERS

DOUBLE ACTING
FLANGE MOUNTING

BE10 Series
1-1/2" to 6" Bore

**F1 — Head Rectangular
Flange Mounting
NFFPA — MF1**

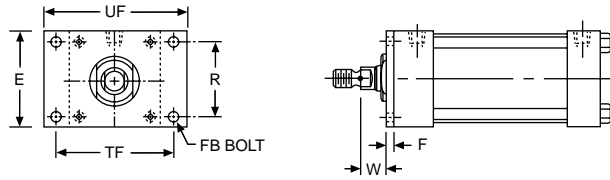

**F2 — Cap Rectangular
Flange Mounting
NFFPA — MF2**

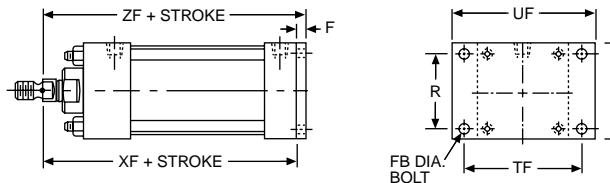

**F5 — Head Square
Flange Mounting
NFFPA — MF5**

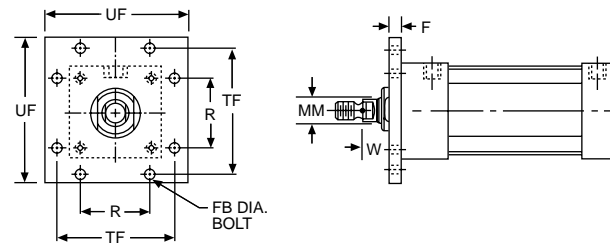

**F6 — Cap Square
Flange Mounting
NFFPA — MF6**

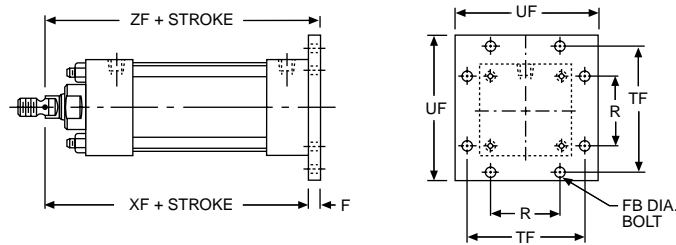

ALL DIMENSIONS IN INCHES

Bore	Rod Dia.	E	F	R	W	FB†	TF	UF	XF	ZF
1-1/2	5/8	2	3/8	1.43	5/8	1/4	2-3/4	3-3/8	4-5/8	5
	1				1					
2	5/8	2-1/2	3/8	1.84	5/8	5/16	3-3/8	4-1/8	4-5/8	5
	1				1				5-3/8	
2-1/2	5/8	3	3/8	2.19	5/8	5/16	3-7/8	4-5/8	4-3/4	5-1/8
	1				1				5-1/8	
3-1/4	1	3-3/4	5/8	2.76	3/4	3/8	4-11/16	5-1/2	5-5/8	6-1/4
	1-3/8				1				5-7/8	
4	1	4-1/2	5/8	3.32	3/4	3/8	5-7/16	6-1/4	5-5/8	6-1/4
	1-3/8				1				5-7/8	
5	1	5-1/2	5/8	4.10	3/4	1/2	6-5/8	7-5/8	5-7/8	6-1/2
	1-3/8				1				6-1/8	
6	1-3/8	6-1/2	3/4	4.88	7/8	1/2	7-5/8	8-5/8	6-5/8	7-3/8
	1-3/4				1-1/8				6-7/8	

†Bolt diameter, holes are 1/16" over bolt diameter.

TIE-ROD CYLINDERS

**DOUBLE ACTING
CLEVIS MOUNTING**

**BE10 Series
1-1/2" to 6" Bore**

**P1 — Cap Fixed
Clevis Mounting
NFPA — MP1**

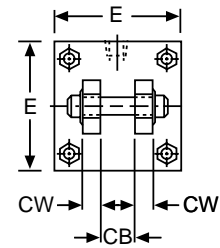
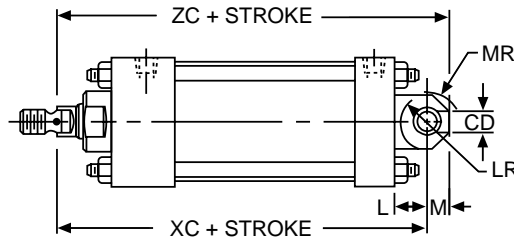

**P2 — Cap Detachable
Clevis Mounting
NFPA — MP2**

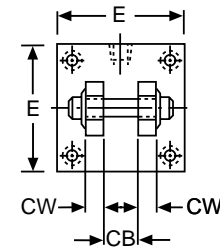
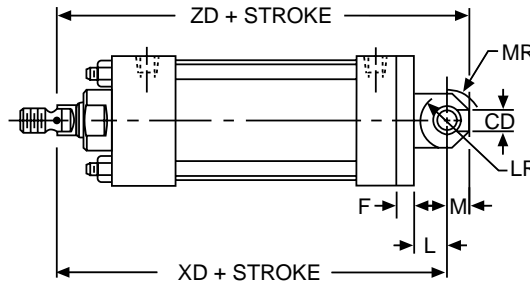

**P3 — Cap Fixed
Eye Mounting
NFPA — MP3**

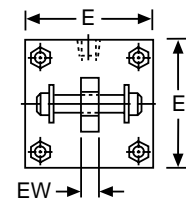
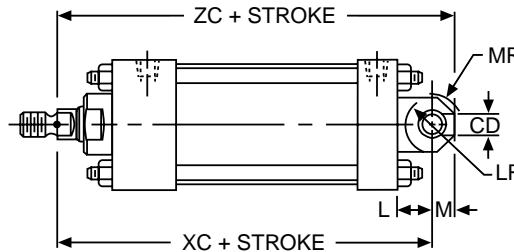

ALL DIMENSIONS IN INCHES

Bore	Rod Dia.	E	F	L	M	CB	CD	CW	EW	LR	MR	XC	XD	ZC	ZD
1-1/2	5/8	2	3/8	3/4	1/2	3/4	1/2	1/2	3/4	5/8	19/32	5-3/8	5-3/4	5-7/8	6-1/4
	1											5-3/4	6-1/8	6-1/4	6-5/8
2	5/8	2-1/2	3/8	3/4	1/2	3/4	1/2	1/2	3/4	5/8	19/32	5-3/8	5-3/4	5-7/8	6-1/4
	1											5-3/4	6-1/8	6-1/4	6-5/8
2-1/2	5/8	3	3/8	3/4	1/2	3/4	1/2	1/2	3/4	5/8	19/32	5-1/2	5-7/8	6	6-3/8
	1											5-7/8	6-1/4	6-3/8	6-3/4
3-1/4	1	3-3/4	5/8	1-1/4	3/4	1-1/4	3/4	5/8	1-1/4	1	7/8	6-7/8	7-1/2	7-5/8	8-1/4
	1-3/8											7-1/8	7-3/4	7-7/8	8-1/2
4	1	4-1/2	5/8	1-1/4	3/4	1-1/4	3/4	5/8	1-1/4	1	7/8	6-7/8	7-1/2	7-5/8	8-1/4
	1-3/8											7-1/8	7-3/4	7-7/8	8-1/2
5	1	5-1/2	5/8	1-1/4	3/4	1-1/4	3/4	5/8	1-1/4	1	7/8	7-1/8	7-3/4	7-7/8	8-1/2
	1-3/8											7-3/8	8	8-1/8	8-3/4
6	1-3/8	6-1/2	3/4	1-1/2	1	1-1/2	1	3/4	1-1/2	1-1/4	1-7/32	8-1/8	8-7/8	9-1/8	9-7/8
	1-3/4											8-3/8	9-1/8	9-3/8	10-1/8

To order, see "How to Order" page 42

TIE-ROD CYLINDERS

DOUBLE ACTING
SIDE/END MOUNTING

BE10 Series
1-1/2" to 6" Bore

S2 — Side Lugs Mounting
NFFA — MS2

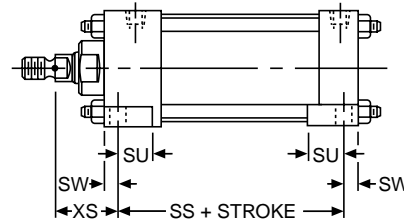
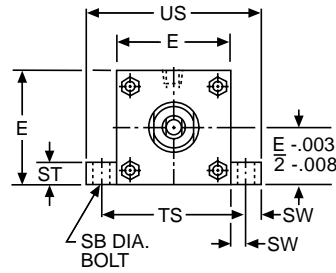

S4 — Side Tapped Mounting
NFFA — MS4

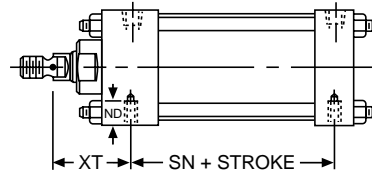
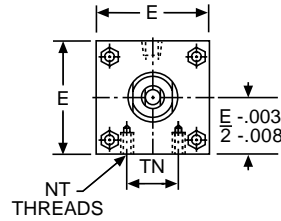

S7 — End Lugs Mounting
NFFA — MS7

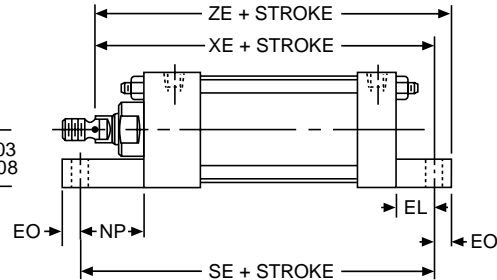
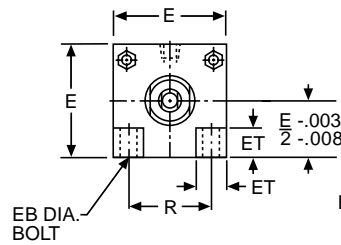

ALL DIMENSIONS IN INCHES

Bore	R	SB†	SE	SN	SS	ST	SU	SW	TN	TS	US
1-1/2	1.43	3/8	5-1/2	2-1/4	2-7/8	1/2	15/16	3/8	5/8	2-3/4	3-1/2
2	1.84	3/8	5-7/8	2-1/4	2-7/8	1/2	15/16	3/8	7/8	3-1/4	4
2-1/2	2.19	3/8	6-1/4	2-3/8	3	1/2	15/16	3/8	1-1/4	3-3/4	4-1/2
3-1/4	2.76	1/2	6-5/8	2-5/8	3-1/4	3/4	1-1/4	1/2	1-1/2	4-3/4	5-3/4
4	3.32	1/2	6-7/8	2-5/8	3-1/4	3/4	1-1/4	1/2	2-1/16	5-1/2	6-1/2
5	4.10	3/4	7-1/4	2-7/8	3-1/8	1	1-9/16	11/16	2-11/16	6-7/8	8-1/4
6	4.88	3/4	7-3/4	3-1/8	3-5/8	1	1-9/16	11/16	3-1/4	7-7/8	9-1/4

ALL DIMENSIONS IN INCHES

Bore	Rod Dia.	E	EB†	EL	EO	ET	ND	NP	NT	XE	XS	XT	ZE
1-1/2	5/8	2	1/4	3/4	1/4	9/16	3/8	1-1/8	1/4-20	5-3/8	1-3/8	1-15/16	5-5/8
	1/4						5-3/4			1-3/4	2-5/16	6	
2	5/8	2-1/2	5/16	15/16	5/16	11/16	9/16	1-5/16	5/16-18	5-9/16	1-3/8	1-15/16	5-7/8
	1						7/16			5-15/16	1-3/4	2-5/16	6-1/4
2-1/2	5/8	3	5/16	1-1/16	5/16	13/16	5/8	1-7/16	3/8-16	5-13/16	1-3/8	1-15/16	6-1/8
	1									6-3/16	1-3/4	2-5/16	6-1/2
3-1/4	1	3-3/4	3/8	7/8	3/8	1	3/4	1-1/2	1/2-13	6-1/2	1-7/8	2-7/16	6-7/8
	1-3/8									6-3/4	2-1/8	2-11/16	7-1/8
4	1	4-1/2	3/8	1	3/8	1-3/16	1	1-5/8	1/2-13	6-5/8	1-7/8	2-7/16	7
	1-3/8									6-7/8	2-1/8	2-11/16	7-1/4
5	1	5-1/2	1/2	1-1/16	1/2	1-3/8	1	1-11/16	5/8-11	6-15/16	2-1/16	2-7/16	7-7/16
	1-3/8									7-3/16	2-5/16	2-11/16	7-11/16
6	1-3/8	6-1/2	1/2	1	1/2	1-5/8	1-1/8	1-3/4	3/4-10	7-5/8	2-5/16	2-13/16	8-1/8
	1-3/4									7-7/8	2-9/16	3-1/16	8-3/8

†Bolt diameter — Holes are 1/16" over bolt diameter.

TIE-ROD CYLINDERS

**DOUBLE ACTING
TRUNNION MOUNTING**

**BE10 Series
1-1/2" to 6" Bore**

**T1 — Head Trunnion
Mounting
NFPA — MT1**

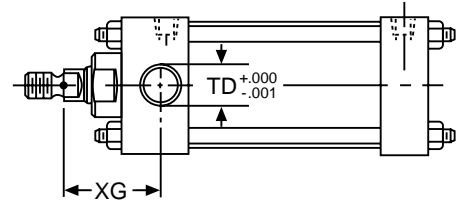
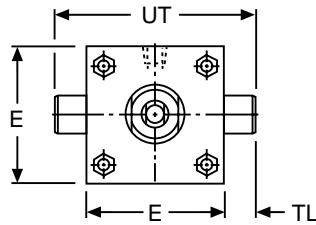

**T2 — Cap Trunnion
Mounting
NFPA — MT2**

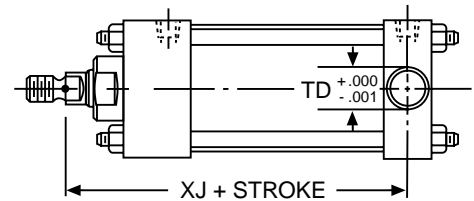
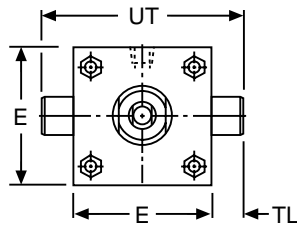

**T4 — Intermediate
Trunnion
Mounting
NFPA — MT4**

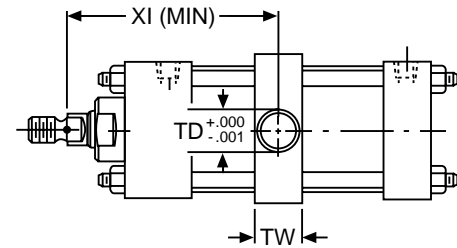
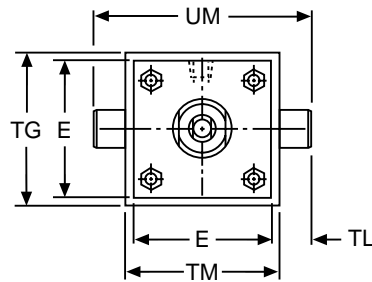

CUSTOMER TO SPECIFY
TRUNNION LOCATION (X1 DIM)

ALL DIMENSIONS IN INCHES

Bore	Rod Dia.	E	TD	TG	TL	TM	TW	UM	UT	XG	XI (MIN)	XJ
1-1/2	5/8	2	1	2-1/2	1	2-1/2	1-1/4	4-1/2	4	1-3/4	3-1/8	4-1/8
	1									3-1/2	4-1/2	
2	5/8	2-1/2	1	3	1	3	1-1/2	5	4-1/2	1-3/4	3-1/4	4-1/8
	1									3-5/8	4-1/2	
2-1/2	5/8	3	1	3-1/2	1	3-1/2	1-1/2	5-1/2	5	1-3/4	3-1/4	4-1/4
	1									3-5/8	4-5/8	
3-1/4	1	3-3/4	1	4-1/4	1	4-1/2	2	6-1/2	5-3/4	2-1/4	4-1/8	5
	1-3/8									4-3/8	5-1/4	
4	1	4-1/2	1	5	1	5-1/4	2	7-1/4	6-1/2	2-1/4	4-1/8	5
	1-3/8									4-3/8	5-1/4	
5	1	5-1/2	1	6	1	6-1/4	2	8-1/4	7-1/2	2-1/4	4-1/8	5-1/4
	1-3/8									4-3/8	5-1/2	
6	1-3/8	6-1/2	1-3/8	7	1-3/8	7-5/8	2-1/2	10-3/8	9-1/4	2-5/8	4-7/8	5-7/8
	1-3/4									5-1/8	6-1/8	

To order, see "How to Order" page 42

BOSTON GEAR®

Fluid Power Catalog

TIE-ROD CYLINDERS

DOUBLE ACTING
TIE ROD MOUNTING

BE10 Series
1-1/2" to 6" Bore

**X1 — Extended Tie Rods
Both Ends
NFFA — MX1**

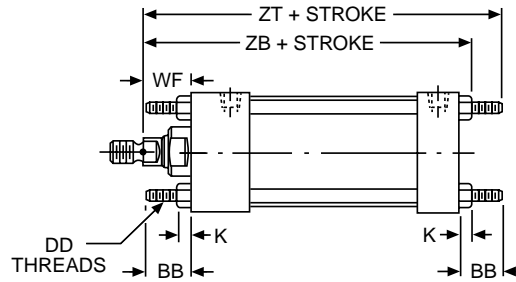
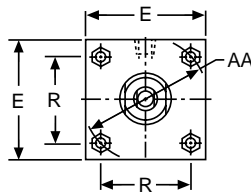

**X2 — Extended Tie Rods
Cap End
NFFA — MX2**

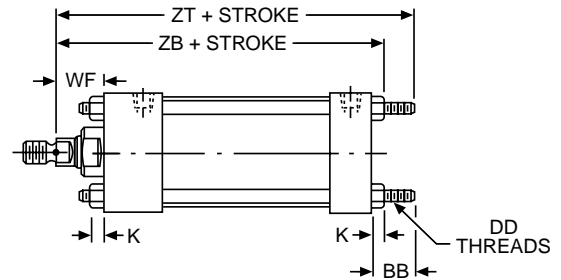
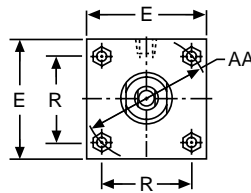

**X3 — Extended Tie Rods
Head End
NFFA — MX3**

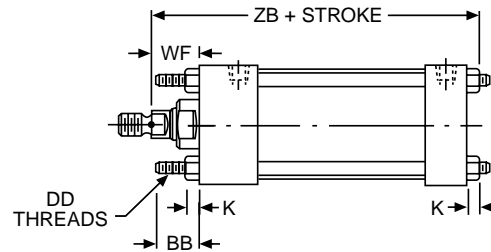
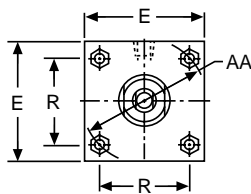

ALL DIMENSIONS IN INCHES

Bore	Rod Dia.	E	K	R	AA	BB	DD	WF	ZB	ZT
1-1/2	5/8	2	1/4	1.43	2.02	1	1/4-28	1	4-7/8	5-5/8
	1							5-1/4	6	
2	5/8	2-1/2	5/16	1.84	2.60	1-1/8	5/16-24	1	4-15/16	5-3/4
	1							5-5/16	6-1/8	
2-1/2	5/8	3	5/16	2.19	3.10	1-1/8	5/16-24	1	5-1/16	5-7/8
	1							5-7/16	6-1/4	
3-1/4	1	3-3/4	3/8	2.76	3.90	1-3/8	3/8-24	1-3/8	6	7
	1-3/8							6-1/4	7-1/4	
4	1	4-1/2	3/8	3.32	4.70	1-3/8	3/8-24	1-3/8	6	7
	1-3/8							6-1/4	7-1/4	
5	1	5-1/2	7/16	4.10	5.80	1-13/16	1-2-20	1-3/8	6-5/16	7-11/16
	1-3/8							6-9/16	7-15/16	
6	1-3/8	6-1/2	7/16	4.88	6.90	1-13/16	1/2-20	1-5/8	7-1/16	8-7/16
	1-3/4							7-5/16	8-11/16	

To order, see "How to Order" page 42

TIE-ROD CYLINDERS

NFPA/JIC
DOUBLE ACTING
1½-8" BORE

BE11/BJ11 Series

BE11 — HEAVY DUTY PNEUMATIC

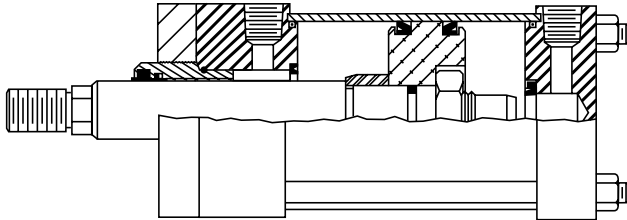

BJ11 — MEDIUM DUTY HYDRAULIC

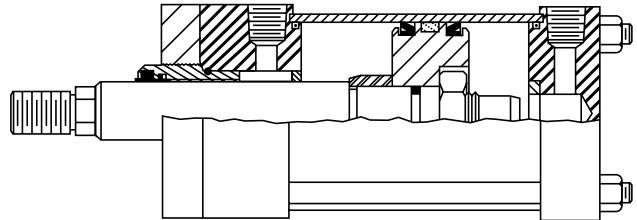

RATINGS (PSIG)

Cylinder Bore	BE11		BJ11	
	Air	Oil	Severe	Moderate (Non Shock)
1-1/2			1500	2000
2			1500	2000
2-1/2			1000	1500
3-1/4	250	500	900	1250
4			750	1000
5			725	950
6			675	900
8			500	750

FEATURES

INDUSTRY INTERCHANGEABLE — Meets NFPA/JIC dimensional standards.

ADJUSTABLE CUSHIONS AVAILABLE

REMOVABLE ROD BEARING — Piloted by the head to provide positive alignment to the tube. It can be easily removed without disturbing the tie rods.

ROD WIPER and ROD SEAL CONTAINED IN THE ROD BEARING — For easy accessibility.

ROD BEARING CONSTRUCTED OF A BRONZE INSERT PRESSED INTO A STEEL HOUSING — To provide maximum side support when the piston is extended.

PISTON ROD — 100,000 psi minimum yield, steel, hard chrome plated and polished smooth to extend seal and rod bearing life.

STEEL TUBING — Honed and chrome plated I.D. for minimum friction and long seal life.

HEAD and CAPS — Machined from precision steel blocks to insure concentricity of piston rod to tubing and to mounting surfaces.

PISTON SEALS — U-cup seals made of Buna-N for minimum friction and positive sealing — BJ11 series piston includes a teflon wear ring to help reduce friction.

TIE RODS — 100,000 psi minimum yield material with rolled threads for added strength.

PISTON — BE11 – Aluminum, BJ11 – Steel

TIE-ROD CYLINDERS

DOUBLE ACTING

BE11/BJ11 Series

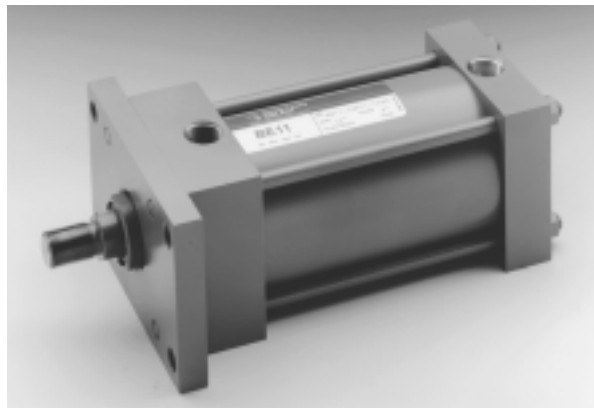

BE11 — HEAVY DUTY, PNEUMATIC
BJ11 — MEDIUM DUTY, HYDRAULIC

HOW TO ORDER BE11/BJ11 SERIES CYLINDERS

To develop a Cylinder Order Number, select only those Code Numbers that represent the cylinder required, and place in the sequence shown below:

EXAMPLE: Required Cylinder — Heavy Duty Air Cylinder, 4" Bore, Detachable Clevis (NFPA Mounting MP2), Standard Rod, Adjustable Cushion Head End, Standard Port location, 73" of Stroke, 1" Standard Rod Diameter, 1-14 Full Diameter Rod Threads.

SPECIFY

Series	Code No.	Bore Dia.	Code No.	Mounting	NFPA Des.	Code No.	Cushions and Rod	Code No.	Port Positions**	Stroke in Code No.	Whole Inches	Code No.	Fractional Stroke Length	Code No.	Modification Descriptions
BE11 Pneumatic	15	- 1-1/2	BX	- None (Basic Cylinder)	—		Standard Rod Diameter		1 - Standard Port Position	01	- 1 inch	0	- No fraction		- Style 1 Standard Thread (code not required — leave blank) 02 - Style 2 Rod End — Full diameter Male Th'd. 03 - Style 3 Rod End — Female Th'd. 04 - Style 4 Rod End — Optional Shoulder, Male Th'd. XX - Special (Specify)
	20	- 2	DBX	- Double Rod (Basic Cylinder)	—				2 - 90° Clockwise Port Position	05	- 5	1	- 1/8 inch		
	25	- 2-1/2	E3	- Head Square (8" bore only)	ME3	1	- Non Cushioned		3 - 180° Clockwise Port Position	12	- 12	2	- 1/4		
	32	- 3-1/4	E4	- Cap Square (8" bore only)	ME4	2	- Cushioned Head End		4 - 270° Clockwise Port Position	25	- 25	3	- 3/8		
	40	- 4	F1	- Head Rectangular Flange*	MF1	3	- Cushioned Cap End			30	- 30	4	- 1/2		
	50	- 5	F2	- Cap Rectangular Flange*	MF2	4	- Cushioned Both Ends			43	- 43	5	- 5/8		
	60	- 6	F5	- Head Square Flange*	MF5		1st Oversize Rod Diameter			66	- 66	6	- 3/4		
	80	- 8	F6	- Cap Square Flange*	MF6		5 - Non Cushioned			etc.		7	- 7/8		
BJ11 Hydraulic			P1	- Cap Fixed Clevis	MP1		6 - Cushioned Head End					9	- For fractions not shown - Specify		
			P2	- Cap Detachable Clevis*	MP2		7 - Cushioned Cap End								
			P3	- Cap Fixed Eye	MP3		8 - Cushioned Both Ends								
			S2	- Side Lugs	MS2		9 - 2nd Oversize Rods and larger-Specify								
			S4	- Side Tapped	MS4										
			S7	- Side End Lugs	MS7										
			T1	- Head Trunnion	MT1										
			T2	- Cap Trunnion	MT2										
			T4	- Intermediate Trunnion	MT4										
			X1	- Extended Tie Rods-Both Ends	MX1										
			X2	- Extended Tie Rods-Cap End	MX2										
		X3	- Extended Tie Rods-Head End	MX3											

Add D to mounting for Double Rod ex. DS4
 *Not available for 8" bore.

**View facing Rod End.

Rod Dia.	ROD DIAMETERS AVAILABLE							
	Bore Dia.							
	1-1/2	2	2-1/2	3-1/4	4	5	6	8
5/8	STD	STD	STD	—	—	—	—	—
1	1st OS†	1st OS	1st OS	STD	STD	STD	—	—
1-3/8	—	A	A	1st OS	1st OS	1st OS	STD	STD
1-3/4	—	—	A	A	A	A	1st OS	1st OS
2	—	—	—	A	A	A	A	A
2-1/2	—	—	—	—	A	A	A	A
3	—	—	—	—	—	A	A	A
3-1/2	—	—	—	—	—	A	A	A
4	—	—	—	—	—	—	A	A
4-1/2	—	—	—	—	—	—	—	A
5	—	—	—	—	—	—	—	A
5-1/2	—	—	—	—	—	—	—	A

STD — Standard Rod Diameter; 1st OS — First Oversized Rod Diameter

A — Available Rod Diameters, Consult Factory

†Adjustable cushion not available on head end; 1-1/2 bore with 1" rod diameter.

TIE-ROD CYLINDERS

**DOUBLE ACTING
BASIC MOUNTING**

**BE11/BJ11 Series
1-1/2" to 8" Bore**

BX — Basic Mounting

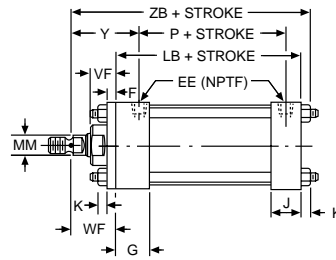
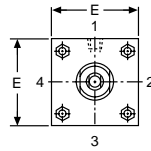

DBX — Double Rod Basic Mounting

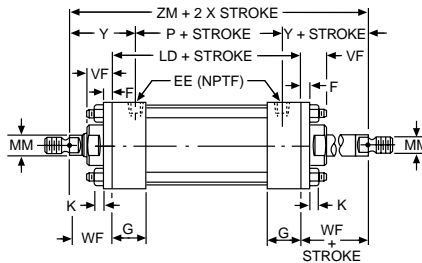
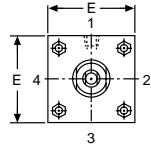

Style 1 Standard unless otherwise specified

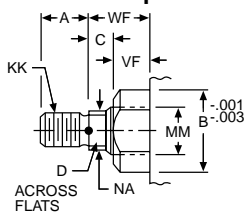

Style 2 Full Diameter Male Thread

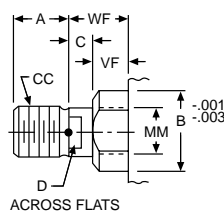

Style 3 Female Thread

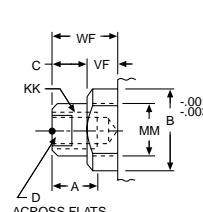

Style 4 Optional Shouldered Male Thread

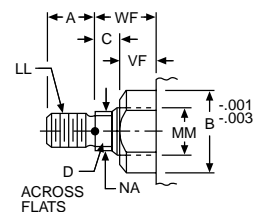

ALL DIMENSIONS IN INCHES

Bore	E	EE (NPTF)	F	G	J	K	LB	LD	P
1-1/2	2	3/8-18	3/8	1-1/2	1	1/4	3-5/8	4-1/8	2-1/4
2	2-1/2	3/8-18	3/8	1-1/2	1	5/16	3-5/8	4-1/8	2-1/4
2-1/2	3	3/8-18	3/8	1-1/2	1	5/16	3-3/4	4-1/4	2-3/8
3-1/4	3-3/4	1/2-14	5/8	1-3/4	1-1/4	3/8	4-1/4	4-3/4	2-5/8
4	4-1/2	1/2-14	5/8	1-3/4	1-1/4	3/8	4-1/4	4-3/4	2-5/8
5	5-1/2	1/2-14	5/8	1-3/4	1-1/4	7/16	4-1/2	5	2-7/8
6	6-1/2	3/4-14	3/4	2	1-1/2	7/16	5	5-1/2	3-1/8
8	8-1/2	3/4-14	3/4	2	1-1/2	9/16	5-1/8	5-5/8	3-1/4

Bore	Rod Dia. (MM)	Thread			A	B	C	D	NA	VF	WF	Y	ZB	ZM
		CC	KK*	LL										
1-1/2	5/8	5/8-18	7/16-20	1/2-20	3/4	1-1/8	3/8	1/2	19/32	5/8	1	1-15/16	4-7/8	6-1/8
	1	1-14	3/4-16	7/8-14	1-1/8	1-1/2	1/2	7/8	31/32	7/8	1-3/8	2-5/16	5-1/4	6-7/8
2	5/8	5/8-18	7/16-20	1/2-20	3/4	1-1/8	3/8	1/2	19/32	5/8	1	1-15/16	4-15/16	6-1/8
	1	1-14	3/4-16	7/8-14	1-1/8	1-1/2	1/2	7/8	31/32	7/8	1-3/8	2-5/16	5-5/16	6-7/8
2-1/2	5/8	5/8-18	7/16-20	1/2-20	3/4	1-1/8	3/8	1/2	19/32	5/8	1	1-15/16	5-1/16	6-1/4
	1	1-14	3/4-16	7/8-14	1-1/8	1-1/2	1/2	7/8	31/32	7/8	1-3/8	2-5/16	5-7/16	7
3-1/4	1	1-14	3/4-16	7/8-14	1-1/8	1-1/2	1/2	7/8	31/32	7/8	1-3/8	2-7/16	6	7-1/2
	1-3/8	1-3/8-12	1-14	1-1/4-12	1-5/8	2	5/8	1-1/8	1-11/32	1	1-5/8	2-11/16	6-1/4	8
4	1	1-14	3/4-16	7/8-14	1-1/8	1-1/2	1/2	7/8	31/32	7/8	1-3/8	2-7/16	6	7-1/2
	1-3/8	1-3/8-12	1-14	1-1/4-12	1-5/8	2	5/8	1-1/8	1-11/32	1	1-5/8	2-11/16	6-1/4	8
5	1	1-14	3/4-16	7/8-14	1-1/8	1-1/2	1/2	7/8	31/32	7/8	1-3/8	2-7/16	6-5/16	7-3/4
	1-3/8	1-3/8-12	1-14	1-1/4-12	1-5/8	2	5/8	1-1/8	1-11/32	1	1-5/8	2-11/16	6-9/16	8-1/4
6	1-3/8	1-3/8-12	1-14	1-1/4-12	1-5/8	2	5/8	1-1/8	1-11/32	1	1-5/8	2-13/16	7-1/16	8-3/4
	1-3/4	1-3/4-12	1-1/4-12	1-1/2-12	2	2-3/8	3/4	1-1/2	1-23/32	1-1/8	1-7/8	3-1/16	7-5/16	9-1/4
8	1-3/8	1-3/8-12	1-14	1-1/4-12	1-5/8	2	5/8	1-1/8	1-11/32	1	1-5/8	2-13/16	7-5/16	8-7/8
	1-3/4	1-3/4-12	1-1/4-12	1-1/2-12	2	2-3/8	3/4	1-1/2	1-23/32	1-1/8	1-7/8	3-1/16	7-9/16	9-3/8

*Standard thread — other threads available.

To order, see "How to Order" page 50

BOSTON GEAR®

Fluid Power Catalog

TIE-ROD CYLINDERS

DOUBLE ACTING
HEAD/CAP MOUNTING

BE11/BJ11 Series
8" Bore

E3 — Head Square Mounting
NFFA — ME3
8" Bore only

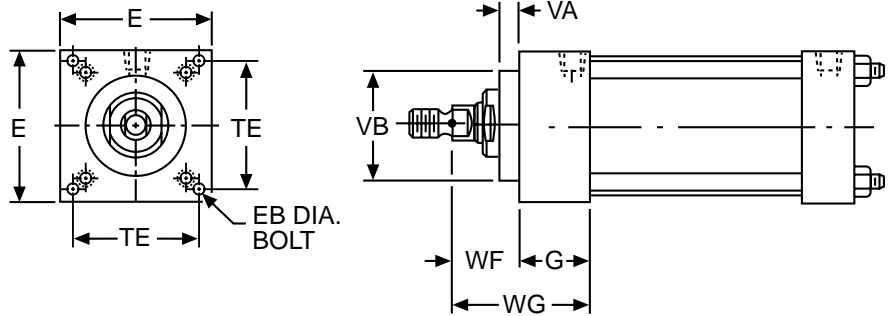

E4 — Cap Square Mounting
NFFA — ME4
8" Bore only

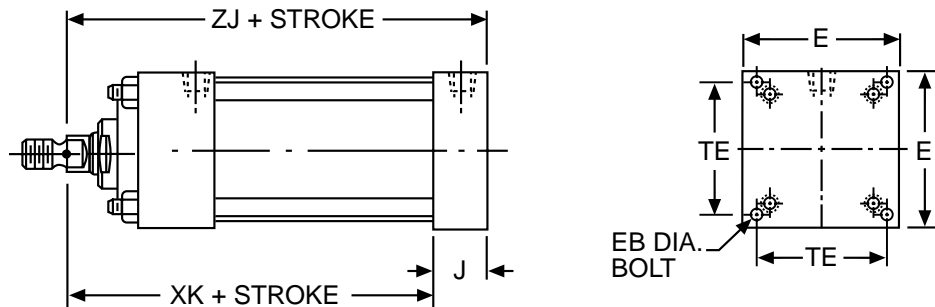

ALL DIMENSIONS IN INCHES

Bore	Rod Dia.	E	EB†	G	J	TE	VA	VB	WF	WG	XK	ZJ
8	1-3/8	8-1/2	5/8	2	1-1/2	7.57	.50	3-5/8	1-5/8	3-5/8	5-1/4	6-3/4
	3-15/16							1-7/8	3-7/8	5-1/2	7	

†Bolt dia. holes are 1/16" over bolt diameter.

To order, see "How to Order" page 50

TIE-ROD CYLINDERS

**DOUBLE ACTING
FLANGE MOUNTING**

**BE11/BJ11 Series
1-1/2" to 6" Bore**

**F1 — Head Rectangular
Flange Mounting
NFFA — MF1
1-1/2" to 6" Bore only**

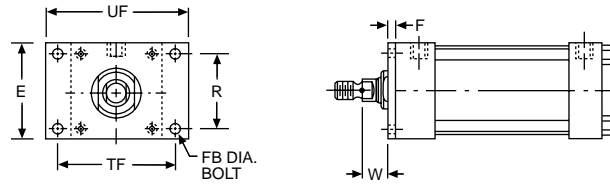

**F2 — Cap Rectangular
Flange Mounting
NFFA — MF2
1-1/2" to 6" Bore only**

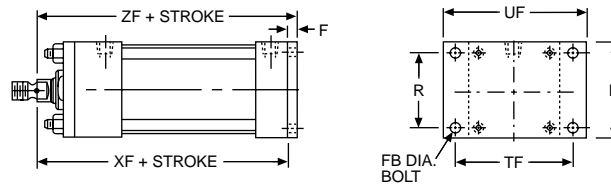

**F5 — Head Square
Flange Mounting
NFFA — MF5
1-1/2" to 6" Bore only**

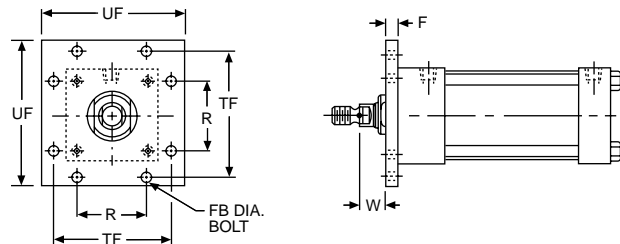

**F6 — Cap Square
Flange Mounting
NFFA — MF6
1-1/2" to 6" Bore only**

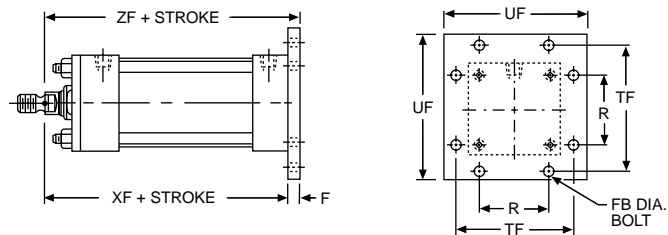

ALL DIMENSIONS IN INCHES

Bore	Rod Dia.	E	F	R	W	FB†	TF	UF	XF	ZF
1-1/2	5/8	2	3/8	1.43	5/8	1/4	2-3/4	3-3/8	4-5/8	5
	1				5				5-3/8	
2	5/8	2-1/2	3/8	1.84	5/8	5/16	3-3/8	4-1/8	4-5/8	5
	1				5				5-3/8	
2-1/2	5/8	3	3/8	2.19	5/8	5/16	3-7/8	4-5/8	4-3/4	5-1/8
	1				5-1/8				5-1/2	
3-1/4	1	3-3/4	5/8	2.76	3/4	3/8	4-11/16	5-1/2	5-5/8	6-1/4
	1-3/8				5-7/8				6-1/2	
4	1	4-1/2	5/8	3.32	3/4	3/8	5-7/16	6-1/4	5-5/8	6-1/4
	1-3/8				5-7/8				6-1/2	
5	1	5-1/2	5/8	4.10	3/4	1/2	6-5/8	7-5/8	5-7/8	6-1/2
	1-3/8				6-1/8				6-3/4	
6	1-3/8	6-1/2	3/4	4.88	7/8	1/2	7-5/8	8-5/8	6-5/8	7-3/8
	1-3/4				6-7/8				7-5/8	

† Bolt dia. Holes are 1/16" over bolt diameter.

To order, see "How to Order" page 50

BOSTON GEAR®

Fluid Power Catalog

TIE-ROD CYLINDERS

**DOUBLE ACTING
CLEVIS MOUNTING**

**BE11/BJ11 Series
1-1/2" to 8" Bore**

**P1 — Cap Fixed
Clevis Mounting
NFPA — MP1**

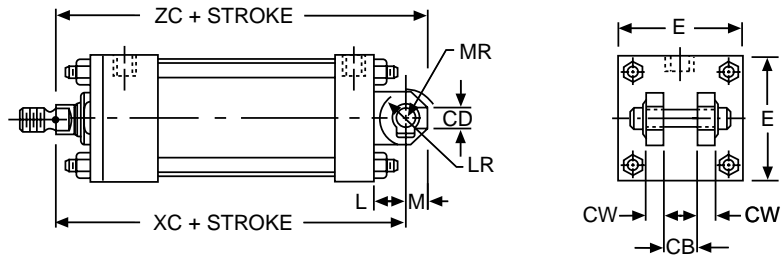

**P2 — Cap Detachable
Clevis Mounting
NFPA — MP2**

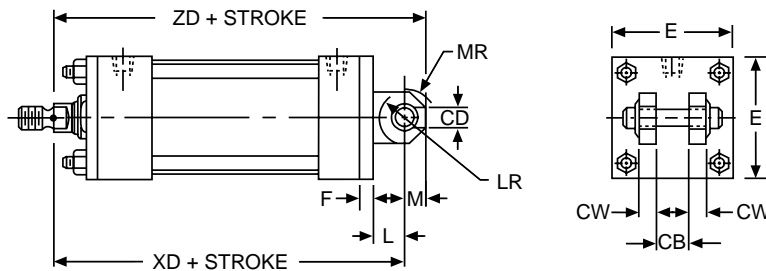

**P3 — Cap Fixed
Eye Mounting
NFPA — MP3**

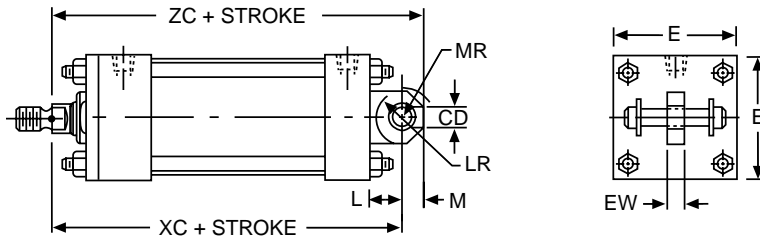

ALL DIMENSIONS IN INCHES

Bore	Rod Dia.	E	F	L	M	CB	CD	CW	EW	LR	MR	XC	XD	ZC	ZD
1-1/2	5/8	2	3/8	3/4	1/2	3/4	1/2	1/2	3/4	5/8	19/32	5-3/8	5-3/4	5-7/8	6-1/4
	1											5-3/4	6-1/8	6-1/4	6-5/8
2	5/8	2-1/2	3/8	3/4	1/2	3/4	1/2	1/2	3/4	5/8	19/32	5-3/8	5-3/4	5-7/8	6-1/4
	1											5-3/4	6-1/8	6-1/4	6-5/8
2-1/2	5/8	3	3/8	3/4	1/2	3/4	1/2	1/2	3/4	5/8	19/32	5-1/2	5-7/8	6	6-3/8
	1											5-7/8	6-1/4	6-3/8	6-3/4
3-1/4	1	3-3/4	5/8	1-1/4	3/4	1-1/4	3/4	5/8	1-1/4	1	7/8	6-7/8	7-1/2	7-5/8	8-1/4
	1-3/8											7-1/8	7-3/4	7-7/8	8-1/2
4	1	4-1/2	5/8	1-1/4	3/4	1-1/4	3/4	5/8	1-1/4	1	7/8	6-7/8	7-1/2	7-5/8	8-1/4
	1-3/8											7-1/8	7-3/4	7-7/8	8-1/2
5	1	5-1/2	5/8	1-1/4	3/4	1-1/4	3/4	5/8	1-1/4	1	7/8	7-1/8	7-3/4	7-7/8	8-1/2
	1-3/8											7-3/8	8	8-1/8	8-3/4
6	1-3/8	6-1/2	3/4	1-1/2	1	1-1/2	1	3/4	1-1/2	1-1/4	1-7/32	8-1/8	8-7/8	9-1/8	9-7/8
	1-3/4											8-3/8	9-1/8	9-3/8	10-1/8
8	1-3/8	8-1/2	3/4	1-1/2	1	1-1/2	1	3/4	1-1/2	1-1/4	1-7/32	8-1/4	9-1/4	9-1/4	10-1/4
	1-3/4											8-1/2	9-1/2	9-1/2	10-1/2

To order, see "How to Order" page 50

TIE-ROD CYLINDERS

**DOUBLE ACTING
END/SIDE MOUNTING**

**BE11/BJ11 Series
1-1/2" to 8" Bore**

**S2 — Side Lugs
Mounting
NFFA — MS2**

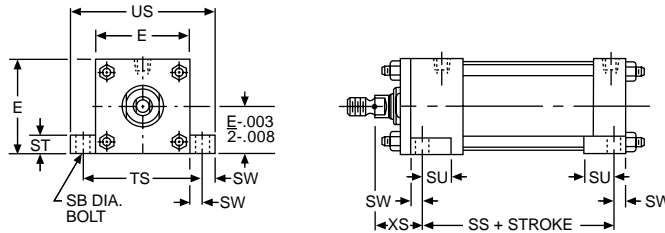

**S4 — Side Tapped
Mounting
NFFA — MS4**

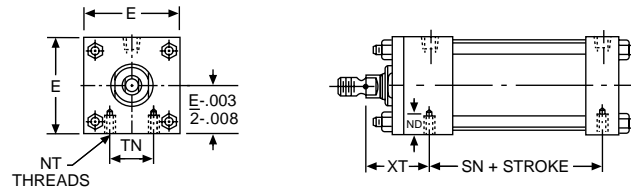

**S7 — End Lugs
Mounting
NFFA — MS7**

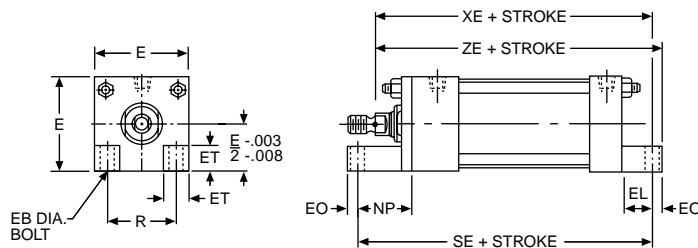

ALL DIMENSIONS IN INCHES

Bore	R	SB†	SE	SN	SS	ST	SU	SW	TN	TS	US
1-1/2	1.43	3/8	5-1/2	2-1/4	2-7/8	1/2	15/16	3/8	5/8	2-3/4	3-1/2
2	1.84	3/8	5-7/8	2-1/4	2-7/8	1/2	15/16	3/8	7/8	3-1/4	4
2-1/2	2.19	3/8	6-1/4	2-3/8	3	1/2	15/16	3/8	1-1/4	3-3/4	4-1/2
3-1/4	2.76	1/2	6-5/8	2-5/8	3-1/4	3/4	1-1/4	1/2	1-1/2	4-3/4	5-3/4
4	3.32	1/2	6-7/8	2-5/8	3-1/4	3/4	1-1/4	1/2	2-1/16	5-1/2	6-1/2
5	4.10	3/4	7-1/4	2-7/8	3-1/8	1	1-9/16	11/16	2-11/16	6-7/8	8-1/4
6	4.88	3/4	7-3/4	3-1/8	3-5/8	1	1-9/16	11/16	3-1/4	7-7/8	9-1/4
8	6.44	3/4	7-3/8	3-1/4	3-3/4	1	1-9/16	11/16	4-1/2	9-7/8	11-1/4

ALL DIMENSIONS IN INCHES

Bore	Rod Dia.	E	EB†	EL	EO	ET	ND	NP	NT	XE	XS	XT	ZE
1-1/2	5/8	2	1/4	3/4	1/4	9/16	3/8	1-1/8	1/4-20	5-3/8	1-3/8	1-15/16	5-5/8
	1						5-3/4			1-3/4	2-5/16	6	
2	5/8	2-1/2	5/16	15/16	5/16	11/16	9/16	1-5/16	5/16-18	5-9/16	1-3/8	1-15/16	5-7/8
	1						5-15/16			1-3/4	2-5/16	6-1/4	
2-1/2	5/8	3	5/16	1-1/16	5/16	13/16	5/8	1-7/16	3/8-16	5-13/16	1-3/8	1-15/16	6-1/8
	1									6-3/16	1-3/4	2-5/16	6-1/2
3-1/4	1	3-3/4	3/8	7/8	3/8	1	3/4	1-1/2	1/2-13	6-1/2	1-7/8	2-7/16	6-7/8
	1-3/8									6-3/4	2-1/8	2-11/16	7-1/8
4	1	4-1/2	3/8	1	3/8	1-3/16	1	1-5/8	1/2-13	6-5/8	1-7/8	2-7/16	7
	1-3/8									6-7/8	2-1/8	2-11/16	7-1/4
5	1	5-1/2	1/2	1-1/16	1/2	1-3/8	1	1-11/16	5/8-11	6-15/16	2-1/16	2-7/16	7-7/16
	1-3/8									7-3/16	2-5/16	2-11/16	7-11/16
6	1-3/8	6-1/2	1/2	1	1/2	1-5/8	1-1/8	1-3/4	3/4-10	7-5/8	2-5/16	2-13/16	8-1/8
	1-3/4									7-7/8	2-9/16	3-1/16	8-3/8
8	1-3/8	8-1/2	5/8	1-1/8	5/8	2	1-1/8	1-1/8	3/4-10	7-7/8	2-5/16	2-13/16	8-1/2
	1-3/4									8-1/8	2-9/16	3-1/16	8-3/4

† Bolt dia., Holes are 1/16" over bolt diameter.

To order, see "How to Order" page 50

BOSTON GEAR®

Fluid Power Catalog

TIE-ROD CYLINDERS

DOUBLE ACTING
TRUNNION MOUNTING

BE11/BJ11 Series
1-1/2" to 8" Bore

**T1 — Head Trunnion
Mounting
NFFPA — MT1**

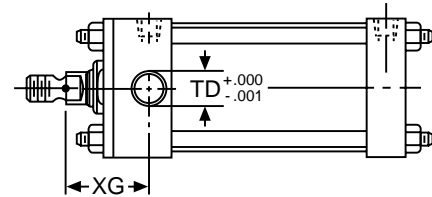
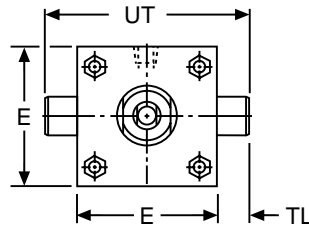

**T2 — Cap Trunnion
Mounting
NFFPA — MT2**

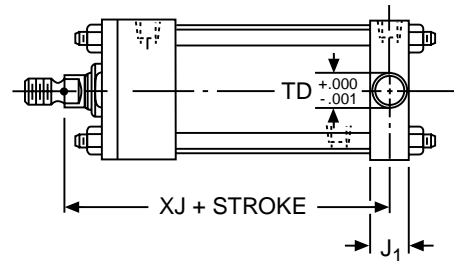
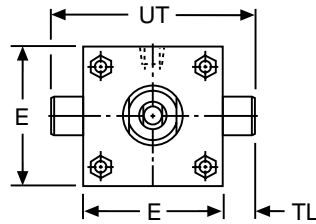

**T4 — Intermediate Trunnion
Mounting
NFFPA — MT4**

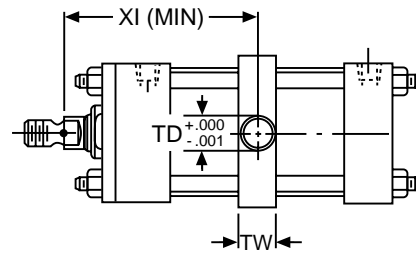
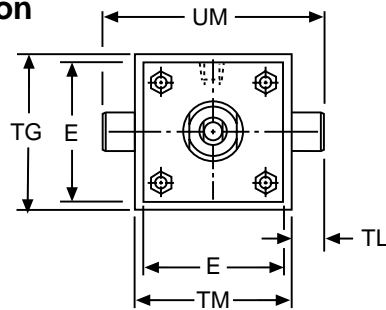

CUSTOMER TO SPECIFY
TRUNNION LOCATION (XI DIM)

ALL DIMENSIONS IN INCHES

Bore	Rod Dia.	E	J1	TD	TG	TL	TM	TW	UM	UT	XG	XI (MIN)	XJ
1-1/2	5/8	2	1-1/8*	1	2-1/2	1	2-1/2	1-1/4	4-1/2	4	1-3/4	3-1/8	4-1/4
	1										2-1/8	3-1/2	4-5/8
2	5/8	2-1/2	1-1/8*	1	3	1	3	1-1/2	5	4-1/2	1-3/4	3-1/4	4-1/4
	1										2-1/8	3-5/8	4-5/8
2-1/2	5/8	3	1-1/8*	1	3-1/2	1	3-1/2	1-1/2	5-1/2	5	1-3/4	3-1/4	4-3/8
	1										2-1/8	3-5/8	4-3/4
3-1/4	1	3-3/4	1-1/4	1	4-1/4	1	4-1/2	2	6-1/2	5-3/4	2-1/4	4-1/8	5
	1-3/8										2-1/2	4-3/8	5-1/4
4	1	4-1/2	1-1/4	1	5	1	5-1/4	2	7-1/4	6-1/2	2-1/4	4-1/8	5
	1-3/8										2-1/2	4-3/8	5-1/4
5	1	5-1/2	1-1/4	1	6	1	6-1/4	2	8-1/4	7-1/2	2-1/4	4-1/8	5-1/4
	1-3/8										2-1/2	4-3/8	5-1/2
6	1-3/8	6-1/2	1-1/2	1-3/8	7	1-3/8	7-5/8	2-1/2	10-3/8	9-1/4	2-5/8	4-7/8	5-7/8
	1-3/4										2-7/8	5-1/8	6-1/8
8	1-3/8	8-1/2	1-1/2	1-3/8	9-1/2	1-3/8	9-3/4	2-1/2	12-1/2	11-1/4	2-5/8	4-7/8	6
	1-3/4										2-7/8	5-1/8	6-1/4

* Dimension exceeds NFFPA by 1/8".

To order, see "How to Order" page 50

TIE-ROD CYLINDERS

DOUBLE ACTING TIE ROD MOUNTING

BE11/BJ11 Series
1-1/2" to 8" Bore

X1 — Extended Tie Rods Both Ends NFFA — MX1

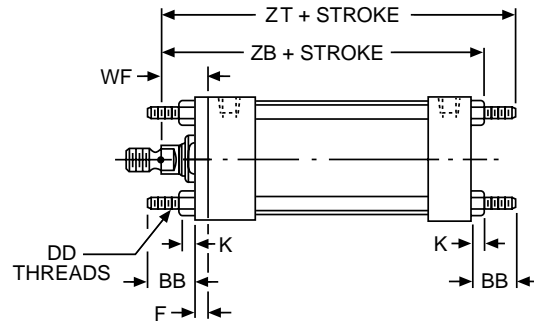
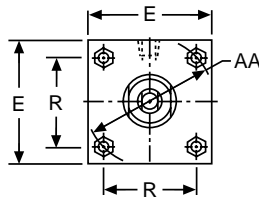

X2 — Extended Tie Rods Cap End NFFA — MX2

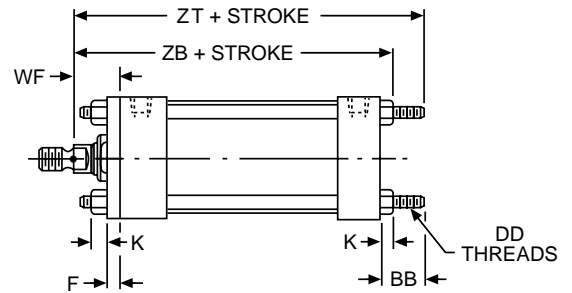
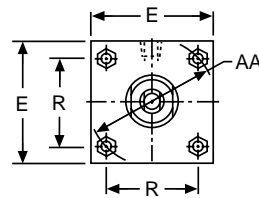

X3 — Extended Tie Rods Head End NFFA — MX3

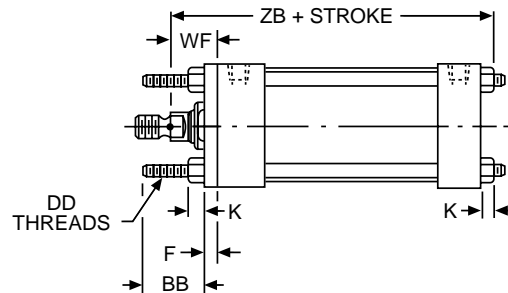
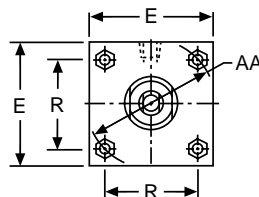

ALL DIMENSIONS IN INCHES

Bore	Rod Dia.	E	F	K	R	AA	BB	DD	WF	ZB	ZT
1-1/2	5/8	2	3/8	1/4	1.43	2.02	1	1/4-28	1	4-7/8	5-5/8
	1								5-1/4	6	
2	5/8	2-1/2	3/8	5/16	1.84	2.60	1-1/8	5/16-24	1	4-15/16	5-3/4
	1								5-5/16	6-1/8	
2-1/2	5/8	3	3/8	5/16	2.19	3.10	1-1/8	5/16-24	1	5-1/16	5-7/8
	1								5-7/16	6-1/4	
3-1/4	1	3-3/4	5/8	3/8	2.76	3.90	1-3/8	3/8-24	1-3/8	6	7
	1-3/8								6-1/4	7-1/4	
4	1	4-1/2	5/8	3/8	3.32	4.70	1-3/8	3/8-24	1-3/8	6	7
	1-3/8								6-1/4	7-1/4	
5	1	5-1/2	5/8	7/16	4.10	5.80	1-13/16	1/2-20	1-3/8	6-5/16	7-11/16
	1-3/8								6-9/16	7-15/16	
6	1-3/8	6-1/2	3/4	7/16	4.88	6.90	1-13/16	1/2-20	1-5/8	7-1/16	8-7/16
	1-3/4								7-5/16	8-11/16	
8	1-3/8	8-1/2	3/4	9/16	6.44	9.10	2-5/16	5/8-18	1-5/8	7-5/16	9-1/16
	1-3/4								7-9/16	9-5/16	

To order, see "How to Order" page 50

TIE ROD CYLINDERS

REPAIR PARTS

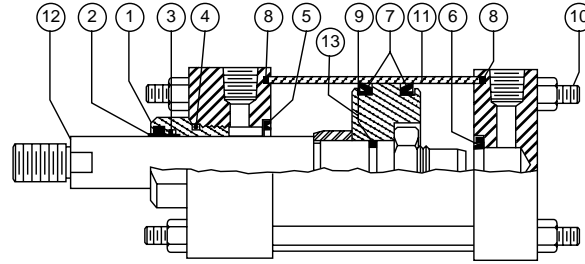

NOT SHOWN:

- (14) WEAR RING PISTON
- (15) O-RING, CUSHION

BE10 Series shown for example

All cylinders are different yet similar in construction

DESCRIPTIONS:

Number	Description
1	Rod Bearing
2	Rod Wiper
3	Rod Packing
4	Bearing O-Ring
5	Cushion Seal (Head)
6	Cushion Seal (Cap)
7	Piston Packing
8	Tube Seals

Number	Description
9	Piston O-Ring
10	Tie Rods (4)
11	Tube
12	Piston Rod
13	Piston
14	Wear Ring (BJ11 only)
15	O-Ring, Cushion Screw

BE10 Series

Body Kit includes: all seals required to rebuild the cylinder body and bearing cartridge for the standard and first oversize rod. For this reason, extra seals are included and you should not use every seal.

Rod Kit includes: Rod Bearing, Bearing O-Ring, Rod Wiper and Rod Packing

To replace all seals — order both the Cylinder Service Kit and the Rod Seal Kit.

BODY KITS SELECT BY BORE DIA.

Bore Dia.	Catalog Number	Item Code
1-1/2	BE10-15BX4-9003	78325
2	BE10-20BX4-9003	78327
2-1/2	BE10-25BX4-9003	78329
3-1/4	BE10-32BX4-9003	78331
4	BE10-40BX4-9003	78333
5	BE10-50BX4-9003	78335
6	BE10-60BX4-9003	78337

ROD KITS SELECT BY ROD DIA.

Rod Dia.	Catalog Number	Item Code
5/8	BE10-15BX4-9002	78326
1	BE10-32BX4-9002	78328
1-3/8	BE10-60BX4-9002	78330
1-3/4	BE10-90BX4-9002	78332
2	BE10-92BX4-9002	78334

TIE ROD CYLINDERS

SEAL KITS

REPAIR PARTS

BE11/BJ11 Series

Body Kit includes: all seals required to rebuild the cylinder body and bearing cartridge for the standard and first oversize rod. For this reason, extra seals are included and you should not use every seal.

Rod Seal Kit includes: Bearing O-Ring, Rod Wiper and Rod Packing

Rod Seal Kit with Rod Bearing includes: Rod Bearing, Bearing O-Ring, Rod Wiper and Rod Packing.

To replace all seals — order both the Cylinder Body Service Kit and the Rod Seal Kit.

CYLINDER BODY SERVICE KITS

SELECT BY BORE DIA.

Bore Dia.	BE11 Cylinder		BJ11 Cylinder	
	Catalog Number	Item Code	Catalog Number	Item Code
1-1/2	BE11-15BX4-9003	73351	BJ11-15BX4-9003	73359
2	BE11-20BX4-9003	73352	BJ11-20BX4-9003	73360
2-1/2	BE11-25BX4-9003	73353	BJ11-25BX4-9003	73361
3-1/4	BE11-32BX4-9003	73354	BJ11-32BX4-9003	73362
4	BE11-40BX4-9003	73355	BJ11-40BX4-9003	73363
5	BE11-50BX4-9003	73356	BJ11-50BX4-9003	73364
6	BE11-60BX4-9003	73357	BJ11-60BX4-9003	73365
8	BE11-80BX4-9003	73358	BJ11-80BX4-9003	73366

ROD SEAL KITS

SELECT BY ROD DIA.

Rod Dia.	Rod Seal Kit		Rod Seal Kit with Rod Bearing	
	Catalog Number	Item Code	Catalog Number	Item Code
5/8	BE11-15BX1-9002	73367	BE11-15BX1-9004	73372
1	BE11-32BX1-9002	73368	BE11-32BX1-9004	73373
1-3/8	BE11-60BX1-9002	73369	BE11-60BX1-9004	73374
1-3/4	BE11-90BX1-9002	73370	BE11-90BX1-9004	73375
2	BE11-92BX1-9002	73371	BE11-92BX1-9004	73376

REPLACEMENT PARTS

Many of the cylinder parts other than those available in repair kits or seal kits can be replaced. To order please specify the complete catalog number of the cylinder and the parts required.

Piston Rod only — Specify rod diameter and thread (will require the assembly of piston from replaced cylinder)

Piston Rod Assembly — Specify rod diameter and thread (will include piston rod, piston and piston packings)

Tube only — Will require seal kit for tube seals at re-assembly

Tie Rods — Set of 4

TIE-ROD CYLINDERS

THEORETICAL PUSH AND PULL STROKE FORCES

PNEUMATIC CYLINDERS

E25, BE10 and BE11 Series

CYLINDER FORCE AND VOLUME CHART — PNEUMATIC

Cyl. Bore	Rod Dia.	Action	Working Area	STROKE FORCE IN POUNDS*									SCF of Air Consumed Per Inch of Stroke At 100 psig Inlet	
				Operating Pressure (psig)										
				50	60	70	80	90	100	150	200	250		
7/16	— 3/16	PUSH	0.150	8	9	11	12	14	15	23	30	38	0.0007	
		PULL	0.123	6	7	9	10	11	12	18	25	31		0.0006
9/16	— 3/16	PUSH	0.249	12	15	17	20	22	25	37	50	62	0.0011	
		PULL	0.221	11	13	15	18	20	22	33	44	55		0.0010
3/4	— 1/4	PUSH	0.442	22	27	31	35	40	44	66	88	110	0.0020	
		PULL	0.393	20	24	27	31	35	39	59	79	98		0.0018
1-1/16	5/16 3/8	PUSH	0.887	44	53	62	71	80	89	133	177	222	0.0040	
		PULL	0.810	40	49	57	65	73	81	121	162	202		0.0037
1-1/4	— 7/16	PUSH	0.776	39	47	54	62	70	78	116	155	194	0.0035	
		PULL	1.227	61	74	86	98	110	123	184	245	307		0.0055
1-1/2	— 7/16	PUSH	1.077	54	65	75	86	97	108	162	215	269	0.0049	
		PULL	1.767	88	106	124	141	159	177	265	353	442		0.0080
1-1/2	7/16 5/8 1	PUSH	1.617	81	97	113	129	146	162	243	323	404	0.0073	
		PULL	1.460	73	88	102	117	131	146	219	292	365		0.0066
		PUSH	0.982	49	59	69	79	88	98	147	196	245		0.0044
		PULL	3.142	157	188	220	251	283	314	471	628	785		
2	5/8 1	PUSH	2.835	142	170	198	227	255	283	425	567	709	0.0128	
		PULL	2.356	118	141	165	188	212	236	353	471	589		0.0106
		PUSH	4.909	245	295	344	393	442	491	736	982	1227		0.0222
2-1/2	5/8 1	PULL	4.602	230	276	322	368	414	460	690	920	1150	0.0208	
		PUSH	4.123	206	247	289	330	371	412	619	825	1031		
		PULL	8.296	415	498	581	664	747	830	1244	1659	2074		0.0375
3-1/4	1 1-3/8	PUSH	7.510	376	451	526	601	676	751	1127	1502	1878	0.0339	
		PULL	6.811	341	409	477	545	613	681	1022	1362	1703		
		PUSH	12.566	628	754	880	1005	1131	1257	1885	2513	3142		0.0567
4	1 1-3/8	PULL	11.781	589	707	825	942	1060	1178	1767	2356	2945	0.0532	
		PUSH	11.082	554	665	776	887	997	1108	1662	2216	2770		
		PULL	19.635	982	1178	1374	1571	1767	1964	2945	3927	4909		0.0887
5	1 1-3/8	PUSH	18.850	942	1131	1319	1508	1696	1885	2827	3770	4712	0.0851	
		PULL	18.150	908	1089	1271	1452	1634	1815	2723	3630	4538		
		PUSH	28.274	1414	1696	1979	2262	2545	2827	4241	5655	7069		0.1277
6	1-3/8 1-3/4	PULL	26.790	1339	1607	1875	2143	2411	2679	4018	5358	6697	0.1210	
		PUSH	25.869	1293	1552	1811	2070	2328	2587	3880	5174	6467		
		PULL	50.266	2513	3016	3519	4021	4524	5027	7540	10053	12566		0.2270
8	1-3/8 1-3/4	PUSH	48.781	2439	2927	3415	3902	4390	4878	7317	9756	12195	0.2203	
		PULL	47.860	2393	2872	3350	3829	4307	4786	7179	9572	11965		
		PUSH												

*Double Acting Only, refer to page 27 for spring forces.

PISTON ROD DIAMETER SELECTION:

Applications requiring long extend (push) strokes may require oversize piston rod diameters to prevent buckling. To determine the correct rod diameter for your application follow these simple steps:

1. Select the thrust from the “**Cylinder Force and Volume Chart**” that is required for your application. Thrust = Piston Surface Area x Operating Pressure.
2. From the “**Cylinder Mounting Diagrams**” select the mounting style being used.
3. With the piston rod fully extended, calculate the value of “D” (in inches) using the formula shown for the cylinder mounting diagram selected in Step #2.
4. Locate the value of “D” (in inches) at the bottom of the “**Selection Chart**”. Enter the chart at this point and move vertically upward until intersecting with the horizontal line representing the required thrust which was selected in Step #1. The band within which these lines intersect represents the minimum recommended piston rod diameter.

TIE-ROD CYLINDERS

THEORETICAL PUSH AND PULL STROKE FORCES

HYDRAULIC CYLINDERS

BJ11 SERIES

CYLINDER FORCE AND VOLUME CHART — HYDRAULIC

Cyl. Bore	Rod Size	Action	Working Area	STROKE FORCE IN POUNDS									Fluid Displacement Per Inch of Stroke (U.S. Gallons)
				Operating Pressure (psig)									
				50	80	100	250	500	750	1000	1500	2000	
1-1/2	—	PUSH	1.767	88	141	177	442	884	1325	1767	2651	3534	.0076
	5/8	PULL	1.460	73	117	146	365	730	1095	1460	2191	2921	.0063
	1	PULL	.982	49	79	98	245	491	736	982	1473	1963	.0042
2	—	PUSH	3.142	157	251	314	785	1571	2356	3142	4712	6283	.0136
	5/8	PULL	2.835	142	227	283	709	1417	2126	2835	4252	5670	.0123
	1	PULL	2.356	118	188	236	589	1178	1767	2356	3534	4712	.0102
2-1/2	—	PUSH	4.909	245	393	491	1227	2454	3682	4909	7363		.0212
	5/8	PULL	4.602	230	368	460	1150	2301	3451	4602	6903		.0199
	1	PULL	4.123	206	330	412	1031	2062	3093	4123	6185		.0178
3-1/4	—	PUSH	8.296	415	664	830	2074	4148	6222	8296	12444		.0359
	1	PULL	7.510	376	601	751	1878	3755	5633	7510	11266		.0325
	1-3/8	PULL	6.811	341	545	681	1703	3405	5108	6811	10216		.0295
4	—	PUSH	12.566	628	1005	1257	3142	6283	9425	12566			.0544
	1	PULL	11.781	589	942	1178	2945	5890	8836	11781			.0510
	1-3/8	PULL	11.081	554	887	1108	2770	5541	8311	11081			.0480
5	—	PUSH	19.635	982	1571	1963	4909	9817	14726	19635			.0850
	1	PULL	18.850	942	1508	1885	4712	9425	14137	18850			.0816
	1-3/8	PULL	18.150	908	1452	1815	4538	9075	13613	18150			.0786
6	—	PUSH	28.274	1414	2262	2827	7069	14137	21206	28274			.1224
	1-3/8	PULL	26.789	1339	2143	2679	6697	13395	20092	26789			.1160
	1-3/4	PULL	25.869	1293	2070	2587	6467	12935	19402	25869			.1120
8	—	PUSH	50.265	2513	4021	5027	12566	25133	37699				.2176
	1-3/8	PULL	48.781	2439	3902	4878	12195	24390	36585				.2112
	1-3/4	PULL	47.860	2393	3829	4786	11965	23930	35895				.2072

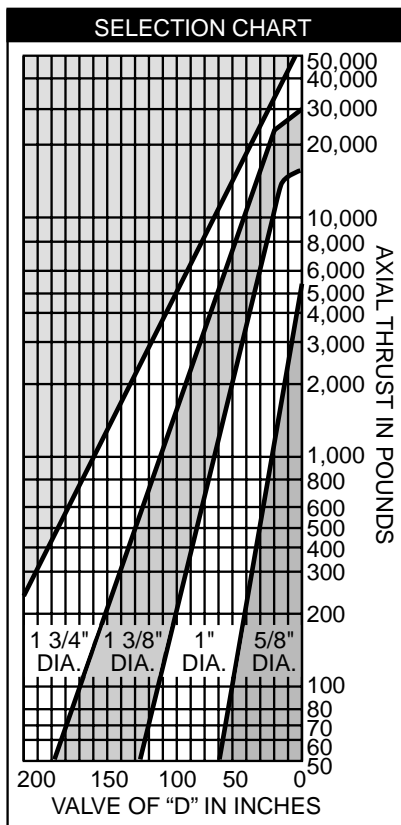

Cylinder Mounting Diagrams All Piston Rods Shown in Extended Position

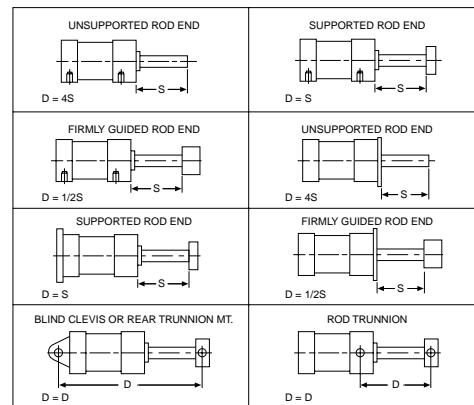

STOP TUBE SELECTION:

Stop tubes enhance the transverse load carrying capability of a long stroke cylinder by increasing the distance between the piston and rod bearing at full extension.

When the value of "D" (calculated from the piston rod diameter selection instructions) is less than 40", a stop tube is NOT required. However, if "D" is 40" or more, one-inch of stop tube is recommended for every 10" (or fraction thereof) over 40".

CYLINDER MOUNTING ACCESSORIES

FOR JIC—NFPA SQUARE END
PNEUMATIC AND HYDRAULIC CYLINDERS

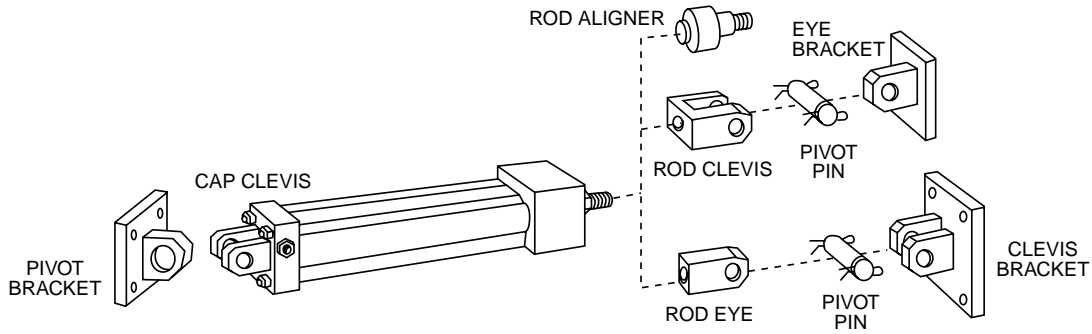

ORDER BY CATALOG NUMBER OR ITEM CODE

KK Rod Thread	Rod		Mating						Mating					
	Aligner		Rod Clevis		Pin		Eye Bracket		Rod Eye		Pin		Clevis Bracket	
	Catalog Number	Item Code	Catalog Number	Item Code	Catalog Number	Item Code	Catalog Number	Item Code	Catalog Number	Item Code	Catalog Number	Item Code	Catalog Number	Item Code
7/16-20	RA-0720-L	74603	FCV-08-0720	71040	PIN-08	71049	EB-08	71043	FRE-08-0720	71037	PIN-08	71049	CVB-08	71046
1/2-20	RA-0820-L	74604	FCV-08-0820	71609	PIN-08	71049	EB-08	71043	FRE-08-0820	71610	PIN-08	71049	CVB-08	71046
5/8-18	RA-1018-L	74605												
3/4-16	RA-1216-L	74607	FCV-12-1216	71041	PIN-12	71050	EB-12	71044	FRE-12-1216	71038	PIN-12	71050	CVB-12	71047
7/8-14	RA-1414-L	74608												
1-14	RA-1614-L	74609	FCV-16-1614	71042	PIN-16	71051	EB-16	71045	FRE-16-1614	71039	PIN-16	71051	CVB-16	71048
1-1/4-12			FCV-22-2012	71605	PIN-22	71607	EB-22	71604	FRE-22-2012	71606	PIN-22	71607	CVB-22	71608
1-1/2-12			FCV-28-2412	71268	PIN-28	79413	EB-28	71085	FRE-28-2412	71236	PIN-28	79413	CVB-28	71088

PIVOT BRACKET FOR CYLINDERS

ORDER BY CATALOG NUMBER OR ITEM CODE

BORE DIA. BE10 BE11/BJ11	C.D. Pin Dia.	For P1 and P2 Mtgs.		For P3 Mtgs.	
		Catalog Number	Item Code	Catalog Number	Item Code
1-1/2, 2, 2-1/2	1/2	EB-08	71043	CVB-08	71046
3-1/4, 4, 5	3/4	EB-12	71044	CVB-12	71047
6, 8	1	EB-16	71045	CVB-16	71048

EYE BRACKET Select by Pin Diameter (CD)

ORDER BY CATALOG NUMBER OR ITEM CODE

CB	CD	For DD Bolt	E	F	FL	LR	M	MR	R	Catalog No.	Item Code
3/4	1/2	3/8	2-1/2	3/8	1-1/8	5/8	1/2	19/32	1-5/8	EB-08	71043
1-1/4	3/4	1/2	3-1/2	5/8	1-7/8	1	3/4	7/8	2-9/16	EB-12	71044
1-1/2	1	5/8	4-1/2	3/4	2-1/4	1-1/4	1	1-7/32	3-1/4	EB-16	71045
2	1-3/8	5/8	5	7/8	3	1-11/16	1-3/8	1-21/32	3-13/16	EB-22	71604
2-1/2	1-3/4	7/8	6-1/2	7/8	3-1/8	1-13/16	1-3/4	2-3/32	4-15/16	EB-28	71085

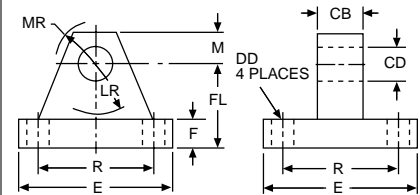

CLEVIS BRACKET Select by Pin Diameter (CD)

ORDER BY CATALOG NUMBER OR ITEM CODE

CB	CD	CW	For DD Bolt	E	F	FL	LR	M	MR	R	Catalog No.	Item Code
3/4	1/2	1/2	3/8	2-1/2	3/8	1-1/8	5/8	1/2	19/32	1-5/8	CVB-08	71046
1-1/4	3/4	5/8	1/2	3-1/2	5/8	1-7/8	1	3/4	7/8	2-9/16	CVB-12	71047
1-1/2	1	3/4	5/8	4-1/2	3/4	2-1/4	1-1/4	1	1-7/32	3-1/4	CVB-16	71048
2	1-3/8	1	5/8	5	7/8	3	1-11/16	1-3/8	1-21/32	3-13/16	CVB-22	71608
2-1/2	1-3/4	1-1/4	7/8	6-1/2	7/8	3-1/8	1-13/16	1-3/4	2-3/32	4-15/16	CVB-28	71088

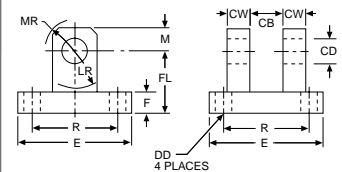

CYLINDER MOUNTING ACCESSORIES

ROD ALIGNER

ORDER BY CATALOG NUMBER OR ITEM CODE

KK	A	C	D	E	F	G	H	Max. Pull At Yield (lbs)	Catalog No.	Item Code
7/16-20	1-1/4	2	1/2	3/4	5/8	1/2	1	10000	RA-0720-L	74603
1/2-20	1-1/4	2	1/2	3/4	5/8	1/2	1	14000	RA-0820-L	74604
5/8-18	1-1/4	2	1/2	3/4	5/8	1/2	1	19000	RA-1018-L	74605
3/4-16	1-3/4	2-5/16	1/2	1-1/8	31/32	13/16	1-1/2	34000	RA-1216-L	74607
7/8-14	1-3/4	2-5/16	1/2	1-1/8	31/32	13/16	1-1/2	39000	RA-1414-L	74608
1-14	2-1/2	2-15/16	1/2	1-5/8	1-3/8	1-5/32	2-1/4	64000	RA-1614-L	74609

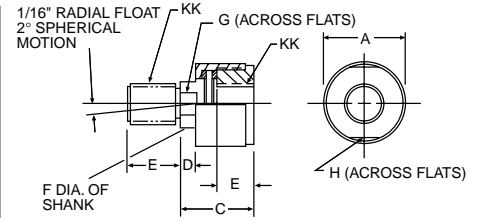

ROD CLEVIS

ORDER BY CATALOG NUMBER OR ITEM CODE

KK	A	CB	CD	CE	CW	ER	Catalog No.	Item
7/16-20	3/4	3/4	1/2	1-1/2	1/2	1/2	FCV-08-0720	71040
1/2-20	3/4	3/4	1/2	1-1/2	1/2	1/2	FCV-08-0820	71609
3/4-16	1-1/8	1-1/4	3/4	2-3/8	5/8	3/4	FCV-12-1216	71041
1-14	1-5/8	1-1/2	1	3-1/8	3/4	1	FCV-16-1614	71042
1-1/4-12	2	2	1-3/8	4-1/8	1	1-3/8	FCV-22-2012	71605
1-1/2-12	2-1/4	2-1/2	1-3/4	4-1/2	1-1/4	1-3/4	FCV-28-2412	71268

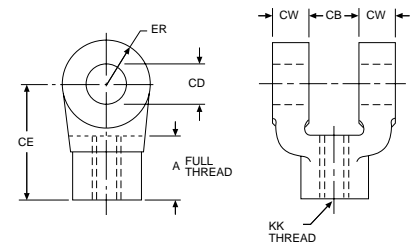

ROD EYE

ORDER BY CATALOG NUMBER OR ITEM CODE

KK	A	CA	CB	CD	ER	Catalog No.	Item Code
7/16-20	3/4	1-1/2	3/4	1/2	9/16	FRE-08-0720	71037
1/2-20	3/4	1-1/2	3/4	1/2	9/16	FRE-08-0820	71610
3/4-16	1-1/8	2-1/16	1-1/4	3/4	27/32	FRE-12-1216	71038
1-14	1-5/8	2-13/16	1-1/2	1	1-1/8	FRE-16-1614	71039
1-1/4-12	2	3-7/16	2	1-3/8	1-1/2	FRE-22-2012	71606
1-1/2-12	2-1/4	4	2-1/2	1-3/4	1-15/16	FRE-28-2412	71236

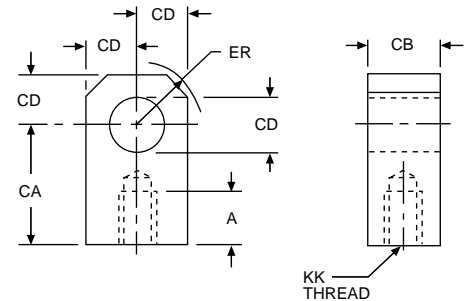

PIN

ORDER BY CATALOG NUMBER OR ITEM CODE

CD	CL	CM	Catalog No.	Item Code
1/2	1-3/4	2-3/8	PIN-08	71049
3/4	2-1/2	3-1/8	PIN-12	71050
1	3	3-5/8	PIN-16	71051
1-3/8	4	4-3/4	PIN-22	71607
1-3/4	5	5-13/16	PIN-28	70413

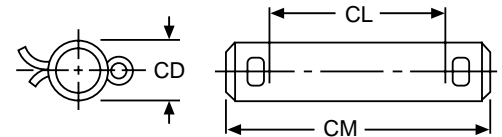

DIRECTIONAL CONTROL VALVES



TABLE OF CONTENTS

	Page
EK SERIES	66-82
SOLENOID OPERATORS	70-71
AIR OPERATORS	72-73
MANUAL OPERATORS	74-79
MECHANICAL OPERATORS	80-81
REPAIR PARTS	68
AIR VALVE SIZING	82-83

VALVE SELECTION CHART

SERIES	PORTS	FUNCTIONS	OPERATORS	BODY	TYPE	CV RANGE
EK	1/4, 3/8 & 1/2 PTF	3 Way / 2 Position 4 Way / 2 Position 4 Way / 3 Position	Solenoid, Air, Manual, Mechanical	Inline	Spool	1.4-1.7

DIRECTIONAL CONTROL VALVES

EK SERIES

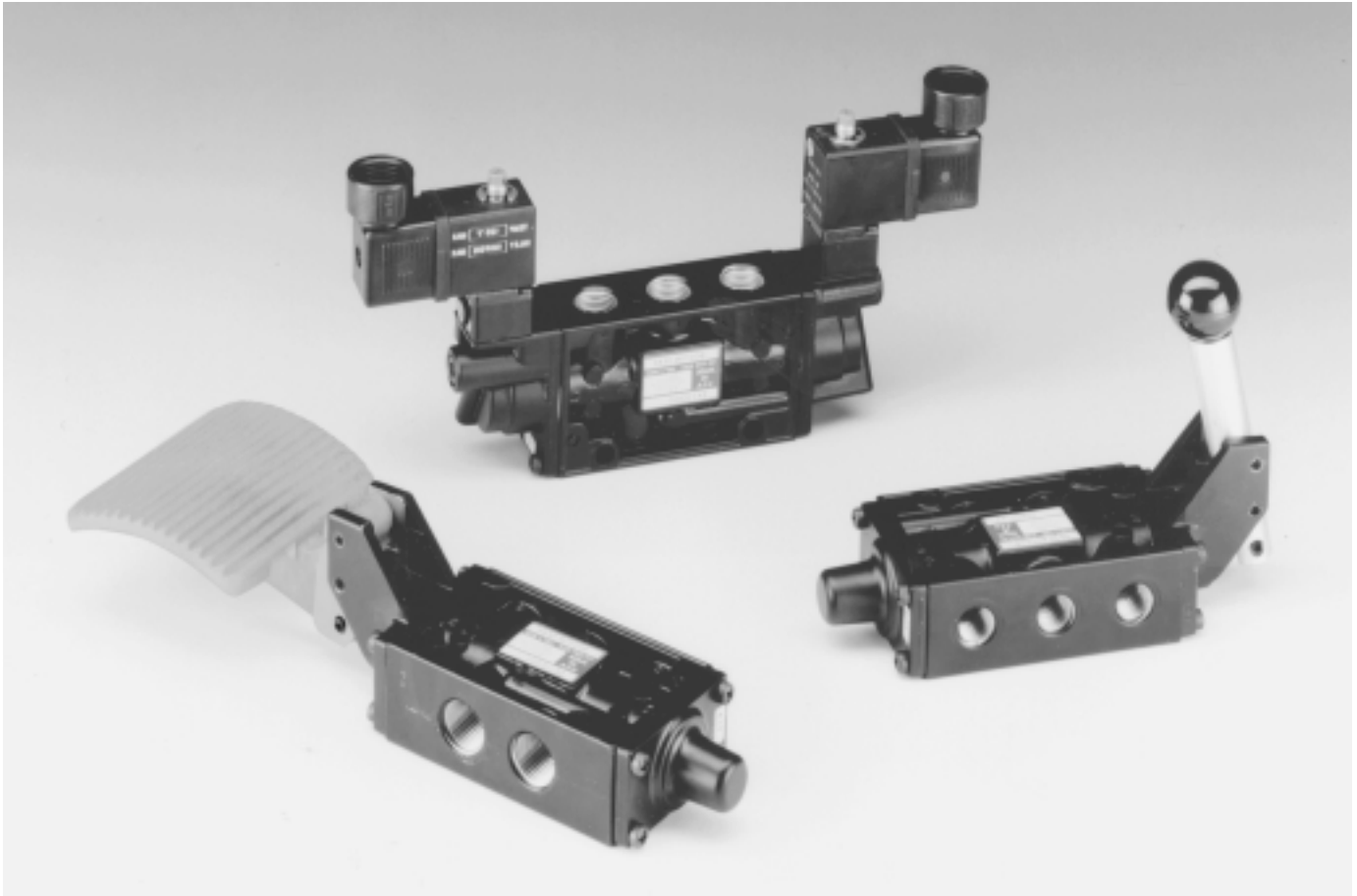

1. RUGGED SOLENOID, AIR, MANUAL OR MECHANICAL OPERATORS

Bodies and operators are made of precision machined aluminum or zinc. Designed to last for millions of cycles.

2. LIGHTWEIGHT, ONE PIECE ALUMINUM SPOOL AND SEAL ASSEMBLY

Shifting forces are minimized because of the low inertial spool made from high strength anodized aluminum. The one-piece spool and seal assembly is easily serviced, resulting in cost savings in maintenance and down time.

3. LOW FRICTION ELASTOMER LIP SEALS

Highly durable low friction lip seals are designed to operate with lubricated or non-lubricated air.

4. SEGMENTED LATCH TYPE DETENT

The spool is held securely in place by a unique segmented detent which engages a lip on the piston.

5. SHOCK ABSORBENT BUMPERS

Valve life is extended because of substantial bumpers which absorb the shock and vibration of the rapidly shifting spool and piston.

6. POSITIVE PORT IDENTIFICATION

Connections made easy because the ports are marked with numerals. Operator end identification shows which ports are connected when the operator is activated.

7. SOLENOID PILOT OPERATORS

Low inrush and holding current provide low power consumption. Manual override (locking and non-locking) provides manual operation.

8. EPOXY COATED

External surfaces of the valve body and operators are protected by a corrosion and chip resistant epoxy paint.

9. INLINE VALVES

Valves mount directly to the air line and are available with the following features:

- 1/4", 3/8", or 1/2" PTF ports.
- 3-Way / 2-Position, 3-Port
- 4-Way / 2-Position, 5-Port
- 4-Way / 3-Position, 5-Port

The 3-way/2-position configuration is not available with 1/2" ports

DIRECTIONAL CONTROL VALVES

EK SERIES

Specifications

Fluids: Filtered and lubricated or non-lubricated compressed air or air at vacuum pressures.

Inlet Pressure Range:

Solenoid Operated Valves:

With Internal Pilot Supply: 15 to 150 PSIG*

With External Pilot Supply: 10" Hg vacuum to 150 PSIG

Air, Manual, or Mechanical Operated Valves: 10" Hg vacuum to 150 PSIG*

Temperature Range (Ambient/Inlet):

Solenoid Operated Valves: -20° to 120°F**

Air, Manual & Mechanical Operated Valves: -20° to 160°F**

Operator Pilot Pressures:

Maximum Pilot Pressure: 150 PSIG

Minimum Pilot Pressure at 150 PSIG.

Main valve inlet pressures are given in the following table:

*Minimum Inlet Pressure is dependent on the type of operator and return used. See Operator Pilot Pressure specifications in Operating Specifications.

**With the dewpoint of supply air less than air temperature below 35°F.

Minimum Pilot Pressure

Operator	Return	Non-Detent PSIG	Detented PSIG	Spring Centered PSIG
Air	Air	15	25	45
Solenoid	Solenoid	15	25	45
Air	Spring	35	—	—
Solenoid	Spring	35	—	—

Air Operator Signal Duration: Air operated 2-position detented or non-detented valves can be shifted with a momentary air signal. Minimum signal duration is 17 milliseconds.

Valve Materials

Body: Aluminum

Spool: Anodized aluminum

Elastomers: Nitrile and special nitrile-based low friction elastomers.

Solenoid Operator Base: PPS Plastic

Solenoid Operator Plunger and Spring: Stainless steel

Seal Compatibility

EK Series Valve seals are compatible with the following lubricants:

DC BR-2+ grease (Dow Corning)

DC44 grease (Dow Corning)

Non-detergent mineral based oil such as Mobil DTE light oil

EK seals are not compatible with WD-40 or commonly used de-icer fluids. Consult factory to verify compatibility of lubricants or fluids not listed above.

Minimum Operating Forces — Manual & Mech. Operators

Operator Number	Description	Force to Operate lbs.
KB0	Palm Button—Spring Return	18.0
KB3	Palm Button — Detent	9.0
KK0	Knob — Spring Return	18.0
KK1	Knob — Detent	9.0
KL0	Lever — Spring Return	9.0
KL1	Lever — Detent, 2-Position	7.0
KL2	Lever — Spring Centered	7.0
KL3	Lever — Detent, 3-Position	7.0
KT0	Treadle — Spring Return	13.0
KT1	Treadle — Detent, 2-Position	9.0
KT2	Treadle — Spring Centered	9.0
KP0	Tappet — Spring Return	18.0
KF0	Foot Pedal — Spring Return	11.0
KR2	Lever Roller — Spring Return	11.0
KR5	One-Way Trip Roller—Spring Return	11.0

Average Flow Factors (Cv)*

Valve	Port Size	Flow Path	
		Port 1 to 2 1 to 4	Port 2 to 3 4 to 5
3-Way Inline	1/4"	1.6	1.7
	3/8"	1.6	1.7
4-Way, Inline	1/4"	1.6	1.7
	3/8"	1.6	1.7
	1/2"	1.6	1.7

*Flow Rating determined in accordance with NFPA/T3.21.3, Pneumatic fluid power—Flow test procedure and reporting method—For fixed orifice components.

WARNING

When a solenoid or air operator is used as a return for a manual or mechanical operator, the pilot pressure applied to the return operator must not exceed 40 PSIG. Pilot pressures greater than 40 PSIG for a solenoid or air return will cause structural damage to the manual or mechanical operator and can also result in injury to the user. If the available pilot pressure exceeds 40 PSIG, an external pilot supply only must be used and a restrictor, part number E54872-02 (73045), must be installed in the pilot port of the return operator to reduce the return force to an acceptable level. Pilot pressure to the restrictor must not exceed 150 PSIG.

E54872-02

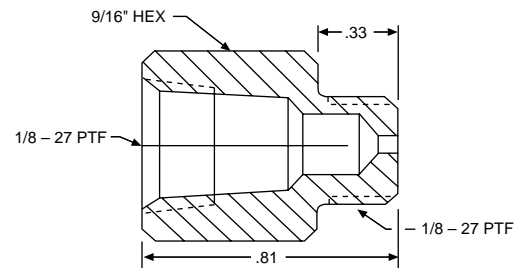

Port Size PTF Standard

Inline Valves: 1/4", 3/8", or 1/2". Valves with 1/2" ports are not available in the 3-way/2-position configuration.

DIRECTIONAL CONTROL VALVES

EK SERIES

Solenoid Operator Specifications

Voltages Available and Power Requirements:

Standard: 120V/60Hz–110V/50Hz: 7W

Optional: 12V/50/60Hz: 7W
 24V/50/60Hz: 7W
 48V/50/60Hz: 7W
 240V/60Hz: 7W
 220V/50Hz: 7W
 12 VDC: 6W
 24 VDC: 6W

Duty: Continuous at 90 to 105% of rated voltage

Coil Type: Class H. Molded with three-pin plug-in connector

Enclosure Classification: NEMA 4, per DIN 40050 — IP 65

Connector Plug: Rotatable 1/2" Conduit Connector

Override: Manual, locking

Pilot Supply: Internal – standard, External – optional

External Pilot Supply Port: 1/8" PTF

Minimum Electrical Signal Duration: Solenoid operated 2-position detented or nondetented valves can be shifted with a momentary electrical signal. Minimum signal duration is 13 milliseconds for single solenoid operated spring return valves. Double solenoid operated valves minimum signal duration is 20 milliseconds.

Electrical connector spades on the operator coil are 3-pin with 11 mm spacing.

Repair Kits

Repair kits are universal and may contain parts not used in your operator. Replace used parts with identical parts from the kit. Discard unused parts. Kits include O-rings and other elastomeric parts, bumpers and bushings.

Item	Catalog Number	Item Code
Air Operator Repair Kit	E54344-16	76844
Solenoid Operator Repair Kit	E54344-17	76845
Spool Assemblies (Includes Spool & Seals)		
3-Way	E54237-59	76846
4-Way (2- and 3-position, all ports blocked in center position)	E54237-56	76847
4-Way (inlet open to cylinder in center position)	E54237-57	76848
4-Way (exhaust open to cylinder in center position)	E54237-58	76849

Replacement Coils

60 Hz	Voltages		Operator Coil Only	Item Code
	50 Hz	DC		
120	110	—	E54452-01	71422
240	220	—	E54452-07	71423
12	12	—	E54452-04	—
24	24	—	E54452-05	71411
48	48	—	E54452-06	—
—	—	12	E54452-02	71421
—	—	24	E54452-03	71419

Port and Operator Identification

Each of the valve ports is identified by a permanent number adjacent to the port in the valve body. See Graphic Symbols below. In addition, a two-digit number at each end of the body indicates the ports connected when the operator at that end is actuated. The numbers 1 2 (read as "one, two") indicate that Ports 1 and 2 are connected when the operator on the 1 2 end is actuated (the valve spool pushed toward the opposite end of the body). The numbers 1 0 or 1 4 at the other end of the body indicate, respectively, that Port 1 is blocked (3-way valves), or that Ports 1 and 4 (4-way valves) are connected when the operator on the 1 0 or 1 4 end is actuated.

Graphic Symbols

C = Outlet E = Exhaust P = Inlet X = Port Plugged

3-WAY 2-POSITION VALVES

3-Way N.C.

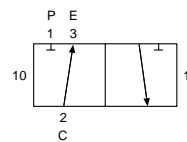

Selector (Dual Pressure)

3-Way N.O.*

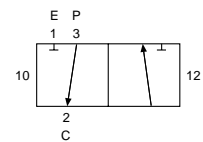

Distributor* (Two Position)

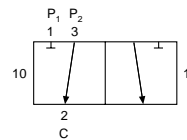

2-Way N.C.

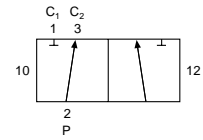
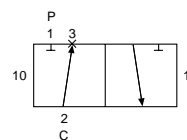

2-Way N.O.*

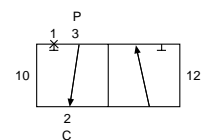

4-WAY 2-POSITION VALVES

Single Pressure

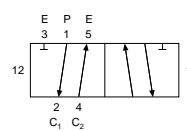

Dual Pressure*

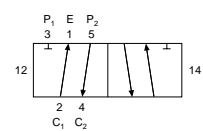

4-WAY 3-POSITION VALVES

Single Pressure

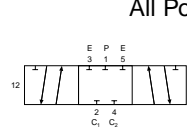

Dual Pressure*

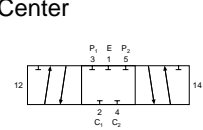

Inlet Open to Cylinder Ports Center

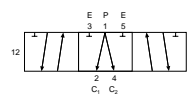

Exhaust Open to Cylinder Ports Center

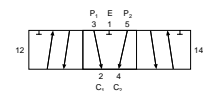
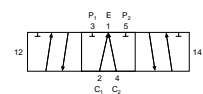
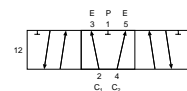

*These operating variations require an external pilot supply if solenoid operators are used.

BOSTON GEAR®

DIRECTIONAL CONTROL VALVES

OPERATOR DIMENSIONS

EK SERIES

Solenoid-K30/K32/K3L

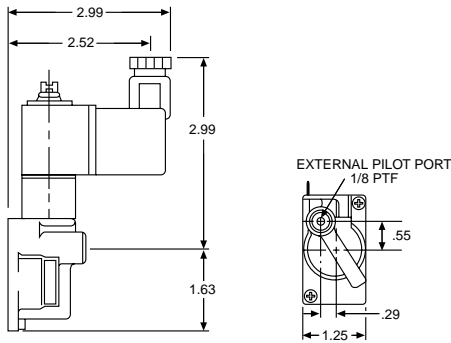

Air-KA2/KAC

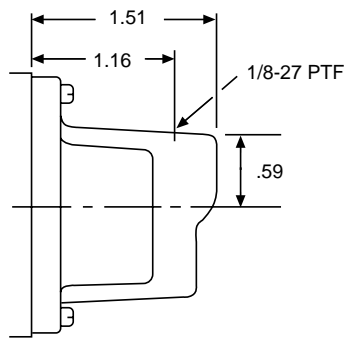

Knob-KK0/KK1

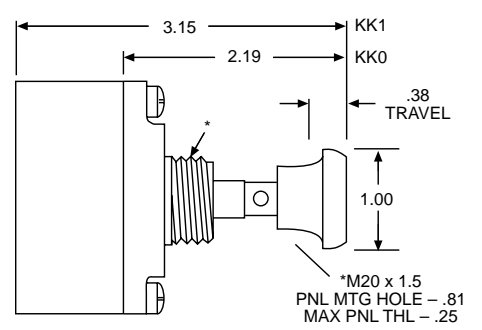

Palm Button-KB0/KB3

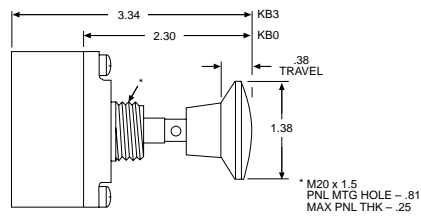

Lever-KL0/KL1/KL2/KL3

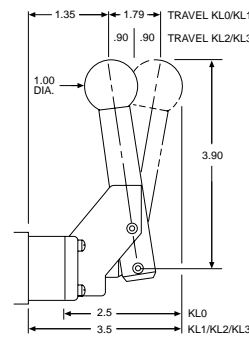

Foot Pedal-KF0

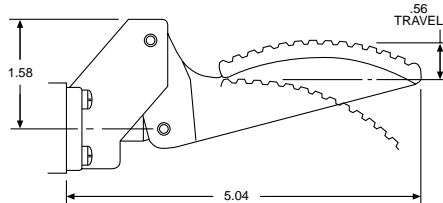

Treadle-KT0/KT1/KT2

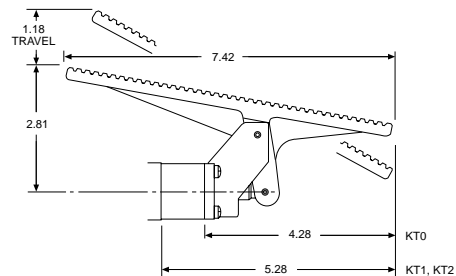

Lever-Roller-KR2

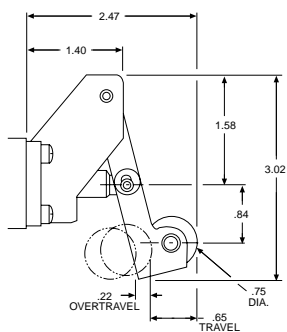

One-Way Roller-KR5

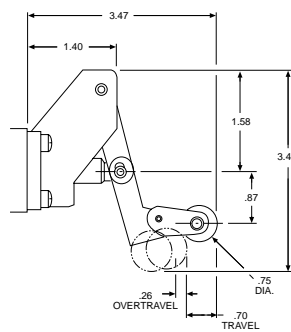

Tappet-KP0

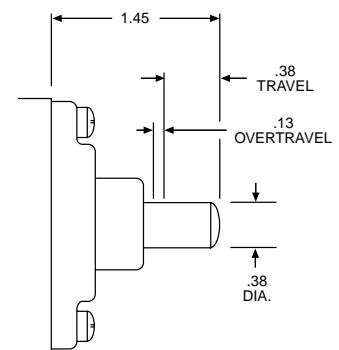

DIRECTIONAL CONTROL VALVES

SOLENOID OPERATORS

EK SERIES

3-WAY / 2-POSITION, 3-PORT

SINGLE SOLENOID SPRING RETURN

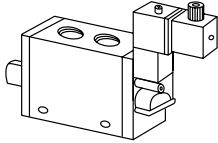

ORDER BY CATALOG NUMBER
OR ITEM CODE

Port Size	Catalog Number	Item Code
1/4	EK41DA00-KS1-K32	74095
3/8	EK41EA00-KS1-K32	74096

DOUBLE SOLENOID NON-DETENT

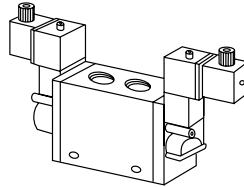

ORDER BY CATALOG NUMBER
OR ITEM CODE

Port Size	Catalog Number	Item Code
1/4	EK41DA00-K32-K32	—
3/8	EK41EA00-K32-K32	—

DOUBLE SOLENOID DETENT

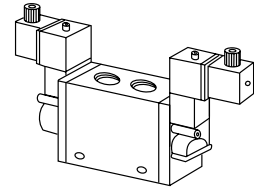

ORDER BY CATALOG NUMBER
OR ITEM CODE

Port Size	Catalog Number	Item Code
1/4	EK41DA00-K3L-K3L	—
3/8	EK41EA00-K3L-K3L	—

4-WAY / 2-POSITION, 5-PORT

SINGLE SOLENOID SPRING RETURN

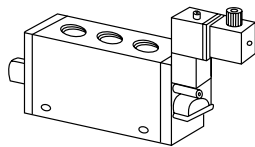

ORDER BY CATALOG NUMBER
OR ITEM CODE

Port Size	Catalog Number	Item Code
1/4	EK71DA00-KS6-K32	74099
3/8	EK71EA00-KS6-K32	74102
1/2	EK71FA00-KS6-K32	79030

DOUBLE SOLENOID NON-DETENT

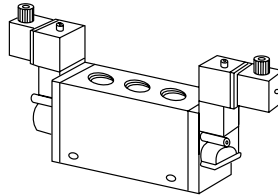

ORDER BY CATALOG NUMBER
OR ITEM CODE

Port Size	Catalog Number	Item Code
1/4	EK71DA00-K32-K32	74097
3/8	EK71EA00-K32-K32	74100
1/2	EK71FA00-K32-K32	79017

DOUBLE SOLENOID DETENT

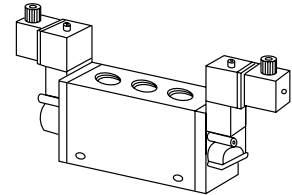

ORDER BY CATALOG NUMBER
OR ITEM CODE

Port Size	Catalog Number	Item Code
1/4	EK71DA00-K3L-K3L	74098
3/8	EK71EA00-K3L-K3L	74101
1/2	EK71FA00-K3L-K3L	79018

4-WAY / 3-POSITION, 5-PORT

DOUBLE SOLENOID SPRING CENTER ALL PORTS BLOCKED

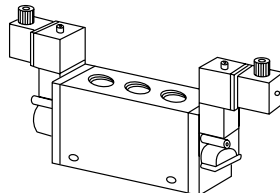

ORDER BY CATALOG NUMBER
OR ITEM CODE

Port Size	Catalog Number	Item Code
1/4	EK81DA00-K30-K30	74115
3/8	EK81EA00-K30-K30	74116
1/2	EK81FA00-K30-K30	79038

NOTE: For 4-Way / 3-Position, 5-Port Valves other spool configuration are available. Change catalog number position 7 and 8 from 00 to XX for different spools as shown below
05 - Inlet open to cylinder ports
06 - Exhaust open to cylinder ports.

DIRECTIONAL CONTROL VALVES

SOLENOID OPERATORS DIMENSIONS

EK SERIES

3-PORT

SINGLE SOLENOID

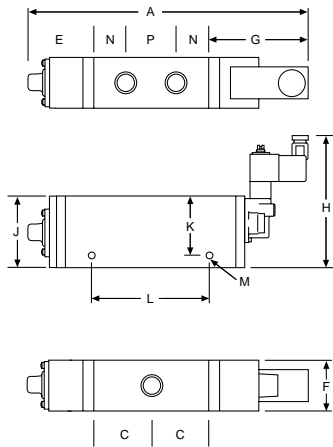

DOUBLE SOLENOID

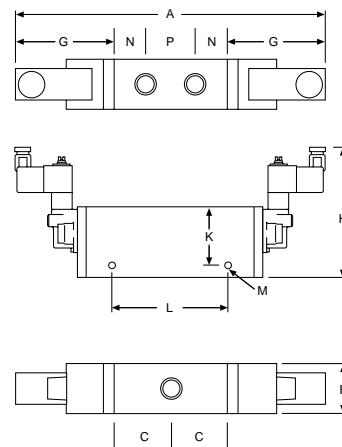

5-PORT

SINGLE SOLENOID

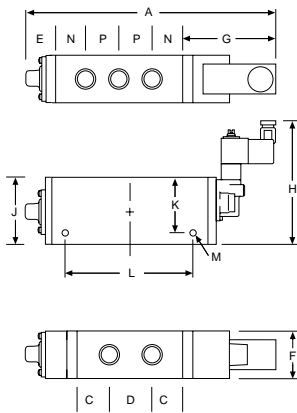

DOUBLE SOLENOID

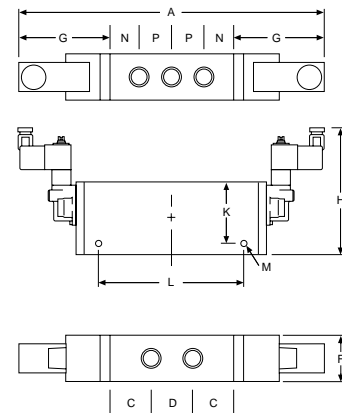

DIMENSIONS — VALVE WITH SOLENOID OPERATOR — ALL DIMENSIONS IN INCHES

Operators	Port Size (PTF)	A	C	D	E	F	G	H	J	K	L	M	N	P
3-Port / 2-Position — Non-Detent														
Single Solenoid	1/4 & 3/8	6.57	1.24	—	1.10	1.26	2.99	4.62	2.16	1.92	1.38	0.26	0.68	1.12
Double Solenoid	1/4 & 3/8	8.46	1.24	—	—	1.26	2.99	4.62	2.16	1.92	1.38	0.26	0.68	1.12
3-Port / 2-Position — Detent														
Double Solenoid	1/4 & 3/8	8.46	1.24	—	—	1.26	2.99	4.62	2.16	1.92	1.38	0.26	0.68	1.12
5-Port / 2-Position — Non-Detent														
Single Solenoid	1/4 & 3/8	7.63	1.22	1.10	1.10	1.26	2.99	4.62	2.16	1.92	2.20	0.26	0.68	1.09
Spring Return	1/2	7.63	1.22	1.10	1.10	1.26	2.99	4.62	2.64	2.16	2.38	0.26	0.68	1.09
Double Solenoid	1/4 & 3/8	9.52	1.22	1.10	—	1.26	2.99	4.62	2.16	1.92	2.20	0.26	0.68	1.09
	1/2	9.52	1.22	1.10	—	1.26	2.99	4.62	2.64	2.16	2.38	0.26	0.68	1.09
5-Port / 2-Position — Detent														
Double Solenoid	1/4 & 3/8	9.52	1.22	1.10	—	1.26	2.99	4.62	2.16	1.92	2.20	0.26	0.68	1.09
	1/2	9.52	1.22	1.10	—	1.26	2.99	4.62	2.64	2.16	2.38	0.26	0.68	1.09
5-Port / 3-Position														
Double Solenoid	1/4 & 3/8	9.52	1.22	1.10	—	1.26	2.99	4.62	2.16	1.92	2.20	0.26	0.68	1.09
Spring Center	1/2	9.52	1.22	1.10	—	1.26	2.99	4.62	2.64	2.16	2.38	0.26	0.68	1.09

DIRECTIONAL CONTROL VALVES

AIR OPERATORS

EK SERIES

3-WAY / 2-POSITION, 3-PORT

**SINGLE AIR
SPRING RETURN**

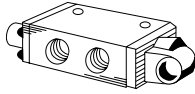

ORDER BY CATALOG NUMBER
OR ITEM CODE

Port Size*	Catalog Number	Item Code
1/4	EK41DA00-KS1-KA2	74180
3/8	EK41EA00-KS1-KA2	74181

*Port in Air Operator is tapped 1/8" PTF

**DOUBLE AIR
NON-DETENT**

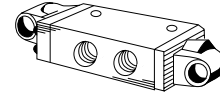

ORDER BY CATALOG NUMBER
OR ITEM CODE

Port Size*	Catalog Number	Item Code
1/4	EK41DA00-KA2-KA2	74182
3/8	EK41EA00-KA2-KA2	75351

*Port in Air Operator is tapped 1/8" PTF

4-WAY / 2-POSITION, 5-PORT

**SINGLE AIR
SPRING RETURN**

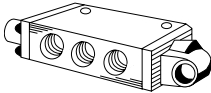

ORDER BY CATALOG NUMBER
OR ITEM CODE

Port Size*	Catalog Number	Item Code
1/4	EK71DA00-KS6-KA2	74184
3/8	EK71EA00-KS6-KA2	74185
1/2	EK71FA00-KS6-KA2	79032

*Port in Air Operator is tapped 1/8" PTF

**DOUBLE AIR
NON-DETENT**

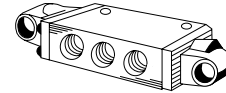

ORDER BY CATALOG NUMBER
OR ITEM CODE

Port Size*	Catalog Number	Item Code
1/4	EK71DA00-KA2-KA2	74270
3/8	EK71EA00-KA2-KA2	74589
1/2	EK71FA00-KA2-KA2	79019

*Port in Air Operator is tapped 1/8" PTF

4-WAY / 3-POSITION, 5-PORT

**DOUBLE AIR
SPRING CENTER
ALL PORTS BLOCKED**

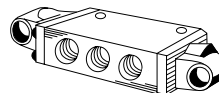

ORDER BY CATALOG NUMBER
OR ITEM CODE

Port Size*	Catalog Number	Item Code
1/4	EK81DA00-KAC-KAC	74188
3/8	EK81EA00-KAC-KAC	74189
1/2	EK81FA00-KAC-KAC	79039

*Port in Air Operator is tapped 1/8" PTF

NOTE: For 4-Way / 3-Position, 5-Port Valves other spool configuration are available. Change catalog number position 7 and 8 from 00 to XX for different spools as shown below
05 - Inlet open to cylinder ports
06 - Exhaust open to cylinder ports.

BOSTON GEAR®

DIRECTIONAL CONTROL VALVES

AIR OPERATORS

EK SERIES

DIMENSIONS

3-PORT

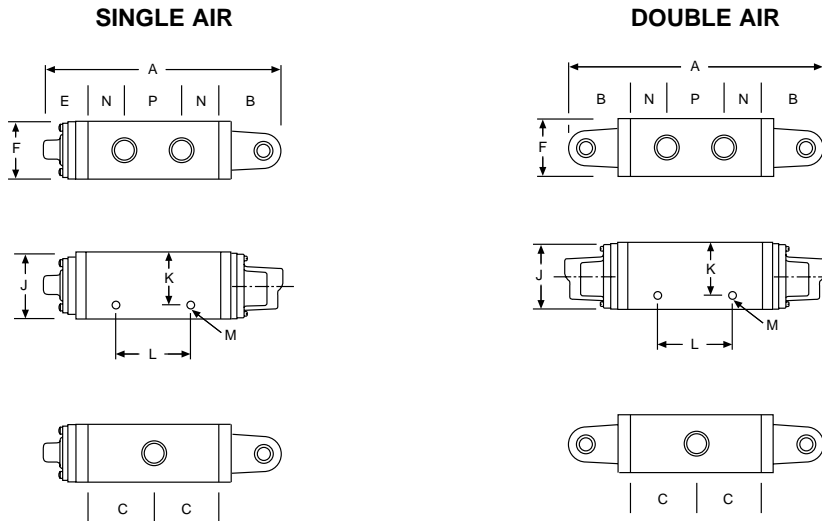

5-PORT

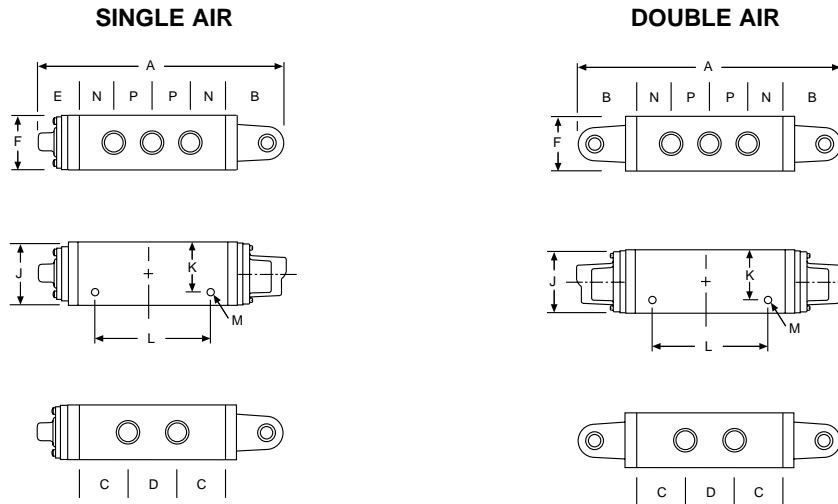

DIMENSIONS — VALVE WITH AIR OPERATOR — ALL DIMENSIONS IN INCHES

Operators	Port Size (PTF)	A	B	C	D	E	F	J	K	L	M	N	P
3 Port / 2 Position — Non-Detent													
Single Air	1/4 & 3/8	5.09	1.51	1.24	—	1.10	1.26	2.16	1.92	1.38	0.26	0.68	1.12
Double Air	1/4 & 3/8	5.50	1.51	1.24	—	—	1.26	2.16	1.92	1.38	0.26	0.68	1.12
5 Port / 2 Position — Non-Detent													
Single Air	1/4 & 3/8	6.15	1.51	1.22	1.10	1.10	1.26	2.16	1.92	2.20	0.26	0.68	1.09
Spring Return	1/2	6.15	1.51	1.22	1.10	1.10	1.26	2.64	2.16	2.38	0.26	0.68	1.09
Double Air	1/4 & 3/8	6.56	1.51	1.22	1.10	—	1.26	2.16	1.92	2.20	0.26	0.68	1.09
	1/2	6.56	1.51	1.22	1.10	—	1.26	2.64	2.16	2.38	0.26	0.68	1.09
5 Port / 3 Position													
Double Air	1/4 & 3/8	6.56	1.51	1.22	1.10	—	1.26	2.16	1.92	2.20	0.26	0.68	1.09
Spring Center	1/2	6.56	1.51	1.22	1.10	—	1.26	2.64	2.16	2.38	0.26	0.68	1.09

DIRECTIONAL CONTROL VALVES

MANUAL OPERATORS – KNOB / PALM BUTTON

EK SERIES

3-WAY / 2-POSITION, 3-PORT

**BLACK KNOB
SPRING RETURN**

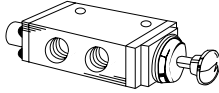

**BLACK KNOB
NON-DETENT**

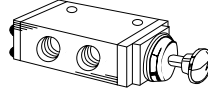

**BLACK KNOB
DETENT**

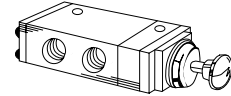

ORDER BY CATALOG NUMBER
OR ITEM CODE

Port Size	Catalog Number	Item Code
1/4	EK41DA00-KS1-KK0	74190
3/8	EK41EA00-KS1-KK0	74191

ORDER BY CATALOG NUMBER
OR ITEM CODE

Port Size	Catalog Number	Item Code
1/4	EK41DA00-KC0-KK0	74152
3/8	EK41EA00-KC0-KK0	75365

ORDER BY CATALOG NUMBER
OR ITEM CODE

Port Size	Catalog Number	Item Code
1/4	EK41DA00-KC0-KK1	74192
3/8	EK41EA00-KC0-KK1	74226

**BLACK PALM BUTTON
SPRING RETURN**

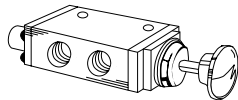

**BLACK PALM BUTTON
DETENT**

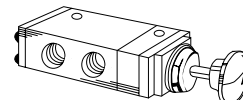

ORDER BY CATALOG NUMBER
OR ITEM CODE

Port Size	Catalog Number	Item Code
1/4	EK41DA00-KS1-KB0	74258
3/8	EK41EA00-KS1-KB0	74262

ORDER BY CATALOG NUMBER
OR ITEM CODE

Port Size	Catalog Number	Item Code
1/4	EK41DA00-KC0-KB3	76816
3/8	EK41EA00-KC0-KB3	76817

4-WAY / 2-POSITION, 5-PORT

**BLACK
KNOB / PALM BUTTON
SPRING RETURN**

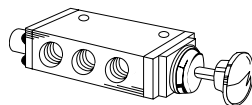

**BLACK
KNOB / PALM BUTTON
DETENT**

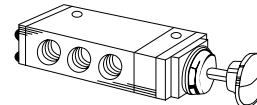

Port Size	Spring Return				Detented			
	Knob		Palm Button		Knob		Palm Button	
	Catalog Number	Item Code	Catalog Number	Item Code	Catalog Number	Item Code	Catalog Number	Item Code
1/4	EK71DA00-KS1-KK0	74237	EK71DA00-KS1-KB0	74386	EK71DA00-KC0-KK1	74250	EK71DA00-KC0-KB3	76820
3/8	EK71EA00-KS1-KK0	74240	EK71EA00-KS1-KB0	74387	EK71EA00-KC0-KK1	74252	EK71EA00-KC0-KB3	76821
1/2	EK71FA00-KS1-KK0	79028	EK71FA00-KS1-KB0	79027	EK71FA00-KC0-KK1	79022	EK71FA00-KC0-KB3	79021

Panel Nut for use with these valves — E616-10 (78398)

BOSTON GEAR®

DIRECTIONAL CONTROL VALVES

MANUAL OPERATORS – KNOB / PALM BUTTON

EK SERIES

DIMENSIONS

3-PORT

NON DETENT

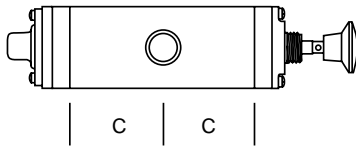
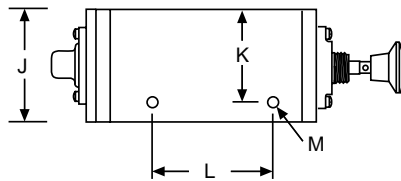
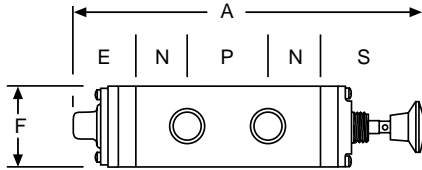

5-PORT

NON DETENT

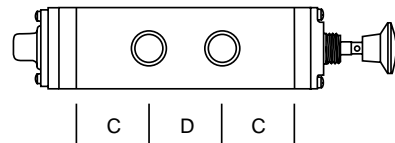
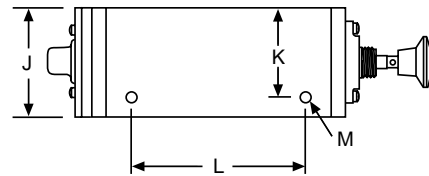
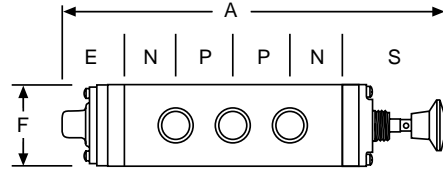

DIMENSIONS — VALVE WITH MANUAL OPERATOR — ALL DIMENSIONS IN INCHES

Operators	Port Size (PTF)	A	C	D	E	F	J	K	L	M	N	P	S
3-Port / 2-Position — Non-Detent													
Knob Spring Return	1/4 & 3/8	5.77	1.24	—	1.10	1.26	2.16	1.92	1.38	0.26	0.68	1.12	2.19
Palm Button Spring Return	1/4 & 3/8	5.88	1.24	—	1.10	1.26	2.16	1.92	1.38	0.26	0.68	1.12	2.30
Knob End Cap	1/4 & 3/8	5.19	1.24	—	.52	1.26	2.16	1.92	1.38	0.26	0.68	1.12	2.19
3-Port / 2-Position — Detent													
Knob End Cap	1/4 & 3/8	6.15	1.24	—	.52	1.26	2.16	1.92	1.38	0.26	0.68	1.12	3.15
Palm Button End Cap	1/4 & 3/8	6.34	1.24	—	.52	1.26	2.16	1.92	1.38	0.26	0.68	1.12	3.34
5-Port / 2-Position — Non-Detent													
Knob	1/4 & 3/8	6.83	1.22	1.10	1.10	1.26	2.16	1.92	2.20	0.26	0.68	1.09	2.19
Spring Return	1/2	6.83	1.22	1.10	1.10	1.26	2.64	2.16	2.38	0.26	0.68	1.09	2.19
Palm Button	1/4 & 3/8	6.94	1.22	1.10	1.10	1.26	2.16	1.92	2.20	0.26	0.68	1.09	2.30
Spring Return	1/2	6.94	1.22	1.10	1.10	1.26	2.64	2.16	2.38	0.26	0.68	1.09	2.30
5-Port / 2-Position — Detent													
Knob	1/4 & 3/8	7.21	1.22	1.10	.52	1.26	2.16	1.92	2.20	0.26	0.68	1.09	3.15
End Cap	1/2	7.21	1.22	1.10	.52	1.26	2.64	2.16	2.38	0.26	0.68	1.09	3.15
Palm Button	1/4 & 3/8	7.40	1.22	1.10	.52	1.26	2.16	1.92	2.20	0.26	0.68	1.09	3.34
End Cap	1/2	7.40	1.22	1.10	.52	1.26	2.64	2.16	2.38	0.26	0.68	1.09	3.34

DIRECTIONAL CONTROL VALVES

MANUAL OPERATORS – LEVER
3-WAY / 2-POSITION, 3-PORT

EK SERIES

SPRING RETURN

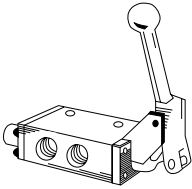

ORDER BY CATALOG NUMBER
OR ITEM CODE

Port Size	Catalog Number	Item Code
1/4	EK41DA00-KS1-KL0	74801
3/8	EK41EA00-KS1-KL0	74822

NON-DETENT

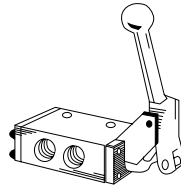

ORDER BY CATALOG NUMBER
OR ITEM CODE

Port Size	Catalog Number	Item Code
1/4	EK41DA00-KC0-KL0	74183
3/8	EK41EA00-KC0-KL0	75352

DETENT

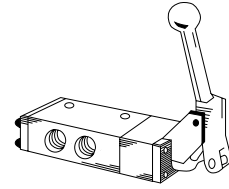

ORDER BY CATALOG NUMBER
OR ITEM CODE

Port Size	Catalog Number	Item Code
1/4	EK41DA00-KC0-KL1	74828
3/8	EK41EA00-KC0-KL1	74832

4-WAY / 2-POSITION, 5-PORT

SPRING RETURN

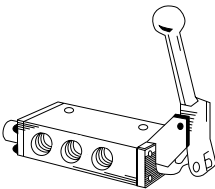

ORDER BY CATALOG NUMBER
OR ITEM CODE

Port Size	Catalog Number	Item Code
1/4	EK71DA00-KS1-KL0	74857
3/8	EK71EA00-KS1-KL0	74858
1/2	EK71FA00-KS1-KL0	79029

NON-DETENT

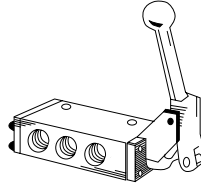

ORDER BY CATALOG NUMBER
OR ITEM CODE

Port Size	Catalog Number	Item Code
1/4	EK71DA00-KC0-KL0	74361
3/8	EK71EA00-KC0-KL0	74788
1/2	EK71FA00-KC0-KL0	79023

DETENT

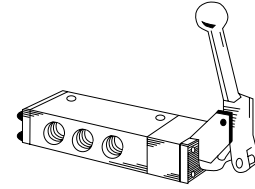

ORDER BY CATALOG NUMBER
OR ITEM CODE

Port Size	Catalog Number	Item Code
1/4	EK71DA00-KC0-KL1	74859
3/8	EK71EA00-KC0-KL1	74860
1/2	EK71FA00-KC0-KL1	79024

4-WAY / 3-POSITION, 5-PORT

SPRING CENTER ALL PORTS BLOCKED

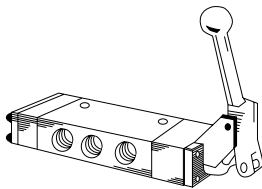

ORDER BY CATALOG NUMBER
OR ITEM CODE

Port Size	Catalog Number	Item Code
1/4	EK81DA00-KC0-KL2	74978
3/8	EK81EA00-KC0-KL2	74980
1/2	EK81FA00-KC0-KL2	79040

DETENT ALL PORTS BLOCKED

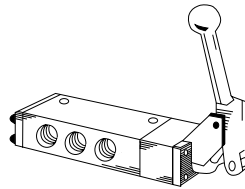

ORDER BY CATALOG NUMBER
OR ITEM CODE

Port Size	Catalog Number	Item Code
1/4	EK81DA00-KC0-KL3	74861
3/8	EK81EA00-KC0-KL3	74977
1/2	EK81FA00-KC0-KL3	79041

NOTE: For 4-Way / 3-Position, 5-Port Valves other spool configuration are available. Change catalog number position 7 and 8 from 00 to XX for different spools as shown below
05 - Inlet open to cylinder ports
06 - Exhaust open to cylinder ports.

DIRECTIONAL CONTROL VALVES

MANUAL OPERATORS – LEVER

EK SERIES

DIMENSIONS

3-PORT

SPRING RETURN

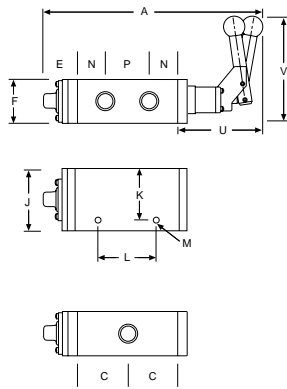

END CAP

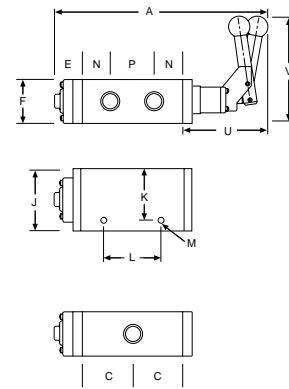

5-PORT

SPRING RETURN

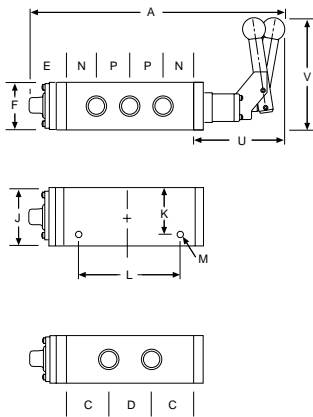

END CAP

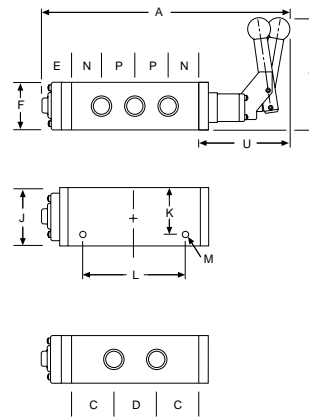

DIMENSIONS — VALVE WITH MANUAL OPERATOR — ALL DIMENSIONS IN INCHES

Operators	Port Size (PTF)	A	C	D	E	F	J	K	L	M	N	P	U	V
3-Port / 2-Position — Non-Detent														
Spring Return	1/4 & 3/8	6.08	1.24	—	1.10	1.26	2.16	1.92	1.38	0.26	0.68	1.12	2.50	4.53
End Cap	1/4 & 3/8	5.50	1.24	—	.52	1.26	2.16	1.92	1.38	0.26	0.68	1.12	2.50	4.53
3-Port / 2-Position — Detent														
End Cap	1/4 & 3/8	6.50	1.24	—	.52	1.26	2.16	1.92	1.38	0.26	0.68	1.12	3.50	4.53
5-Port / 2-Position — Non-Detent														
Spring Return	1/4 & 3/8	7.14	1.22	1.10	1.10	1.26	2.16	1.92	2.20	0.26	0.68	1.09	2.50	4.53
	1/2	7.14	1.22	1.10	1.10	1.26	2.64	2.16	2.38	0.26	0.68	1.09	2.50	4.53
End Cap	1/4 & 3/8	6.56	1.22	1.10	.52	1.26	2.16	1.92	2.20	0.26	0.68	1.09	2.50	4.53
	1/2	6.56	1.22	1.10	.52	1.26	2.64	2.16	2.38	0.26	0.68	1.09	2.50	4.53
5-Port / 2-Position — Detent														
End Cap	1/4 & 3/8	7.56	1.22	1.10	.52	1.26	2.16	1.92	2.20	0.26	0.68	1.09	3.50	4.53
	1/2	7.56	1.22	1.10	.52	1.26	2.64	2.16	2.38	0.26	0.68	1.09	3.50	4.53
5-Port / 3-Position														
Spring Center	1/4 & 3/8	8.56	1.22	1.10	1.52	1.26	2.16	1.92	2.20	0.26	0.68	1.09	3.50	4.53
	1/2	8.56	1.22	1.10	1.52	1.26	2.64	2.16	2.38	0.26	0.68	1.09	3.50	4.53
Detent	1/4 & 3/8	7.56	1.22	1.10	.52	1.26	2.16	1.92	2.20	0.26	0.68	1.09	3.50	4.53
	1/2	7.56	1.22	1.10	.52	1.26	2.64	2.16	2.38	0.26	0.68	1.09	3.50	4.53

DIRECTIONAL CONTROL VALVES

MANUAL OPERATORS – FOOT PEDAL / TREADLE 3-WAY / 2-POSITION, 3-PORT

EK SERIES

**FOOT PEDAL
SPRING RETURN**

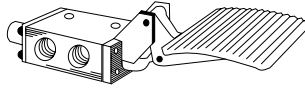

ORDER BY CATALOG NUMBER
OR ITEM CODE

Port Size	Catalog Number	Item Code
1/4	EK41DA00-KS1-KF0	74982
3/8	EK41EA00-KS1-KF0	74985

**TREADLE
NON-DETENT**

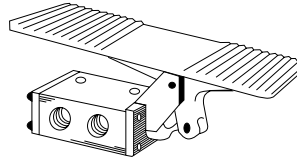

ORDER BY CATALOG NUMBER
OR ITEM CODE

Port Size	Catalog Number	Item Code
1/4	EK41DA00-KC0-KT0	74157
3/8	EK41EA00-KC0-KT0	75373

**TREADLE
DETENT**

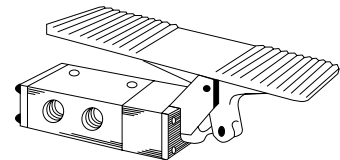

ORDER BY CATALOG NUMBER
OR ITEM CODE

Port Size	Catalog Number	Item Code
1/4	EK41DA00-KC0-KT1	74989
3/8	EK41EA00-KC0-KT1	74993

Foot pedal valves should be ordered with foot guard to meet OSHA requirements. See below for ordering information.

4-WAY / 2-POSITION, 5-PORT

**FOOT PEDAL
SPRING RETURN**

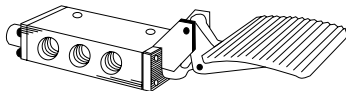

ORDER BY CATALOG NUMBER
OR ITEM CODE

Port Size	Catalog Number	Item Code
1/4	EK71DA00-KS6-KF0	75065
3/8	EK71EA00-KS6-KF0	75066
1/2	EK71FA00-KS6-KF0	79034

**TREADLE
NON-DETENT**

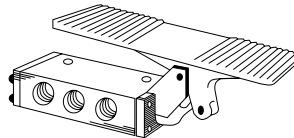

ORDER BY CATALOG NUMBER
OR ITEM CODE

Port Size	Catalog Number	Item Code
1/4	EK71DA00-KC0-KT0	74365
3/8	EK71EA00-KC0-KT0	78614
1/2	EK71FA00-KC0-KT0	79025

**TREADLE
DETENT**

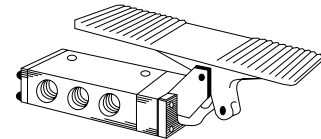

ORDER BY CATALOG NUMBER
OR ITEM CODE

Port Size	Catalog Number	Item Code
1/4	EK71DA00-KC0-KT1	75067
3/8	EK71EA00-KC0-KT1	75068
1/2	EK71FA00-KC0-KT1	79026

Foot pedal valves should be ordered with foot guard to meet OSHA requirements. See below for ordering information.

4-WAY / 3-POSITION, 5-PORT

**TREADLE
SPRING CENTER
ALL PORTS BLOCKED**

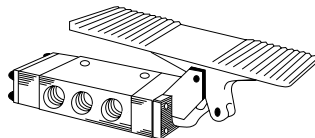

ORDER BY CATALOG NUMBER
OR ITEM CODE

Port Size	Catalog Number	Item Code
1/4	EK81DA00-KC0-KT2	75069
3/8	EK81EA00-KC0-KT2	75070
1/2	EK81FA00-KC0-KT2	79042

NOTE: For 4-Way / 3-Position, 5-Port Valves other spool configuration are available. Change catalog number position 7 and 8 from 00 to XX for different spools as shown below
05 - Inlet open to cylinder ports
06 - Exhaust open to cylinder ports.

FOOTGUARD
ORDER NO. E54842-66 (74634)

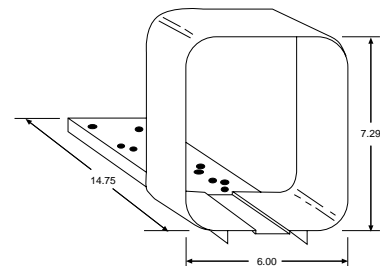

BOSTON GEAR®

DIRECTIONAL CONTROL VALVES

MANUAL OPERATORS – FOOT PEDAL / TREADLE

EK SERIES

DIMENSIONS

3-PORT

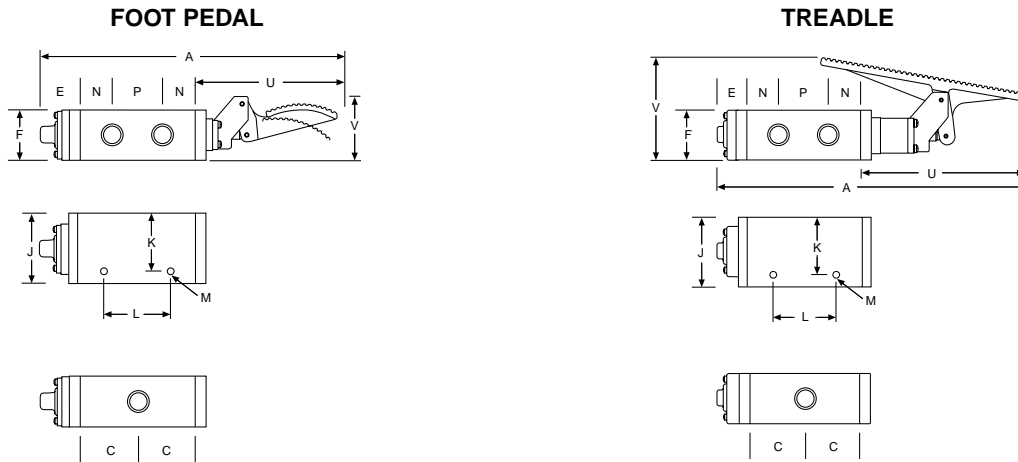

5-PORT

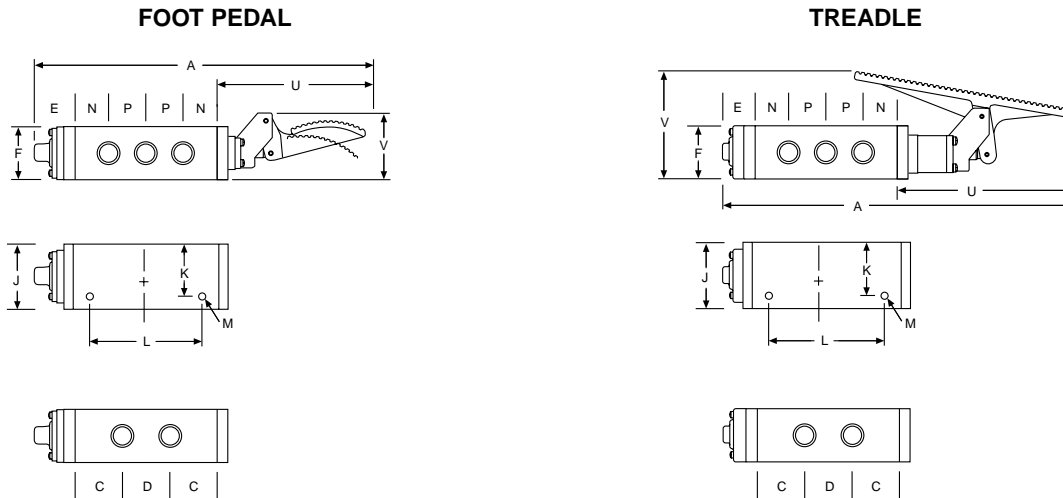

DIMENSIONS — VALVE WITH MANUAL OPERATOR — ALL DIMENSIONS IN INCHES

Operators	Port Size (PTF)	A	C	D	E	F	J	K	L	M	N	P	U	V
3-Port / 2-Position — Non-Detent														
Foot Pedal	1/4 & 3/8	8.62	1.24	—	1.10	1.26	2.16	1.92	1.38	0.26	0.68	1.12	5.04	2.21
Treadle	1/4 & 3/8	7.28	1.24	—	.52	1.26	2.16	1.92	1.38	0.26	0.68	1.12	4.28	3.44
3-Port / 2-Position — Detent														
Treadle	1/4 & 3/8	8.28	1.24	—	.52	1.26	2.16	1.92	1.38	0.26	0.68	1.12	5.28	3.44
5-Port / 2-Position — Non-Detent														
Foot Pedal	1/4 & 3/8	9.68	1.22	1.10	1.10	1.26	2.16	1.92	2.20	0.26	0.68	1.09	5.04	2.21
Spring Return	1/2	9.68	1.22	1.10	1.10	1.26	2.64	2.16	2.38	0.26	0.68	1.09	5.04	2.21
Treadle	1/4 & 3/8	8.34	1.22	1.10	.52	1.26	2.16	1.92	2.20	0.26	0.68	1.09	4.28	3.44
End Cap	1/2	8.34	1.22	1.10	.52	1.26	2.64	2.16	2.38	0.26	0.68	1.09	4.28	3.44
5-Port / 2-Position — Detent														
Treadle	1/4 & 3/8	9.34	1.22	1.10	.52	1.26	2.16	1.92	2.20	0.26	0.68	1.09	5.28	3.44
End Cap	1/2	9.34	1.22	1.10	.52	1.26	2.64	2.16	2.38	0.26	0.68	1.09	5.28	3.44
5-Port / 3-Position														
Treadle	1/4 & 3/8	10.34	1.22	1.10	1.52	1.26	2.16	1.92	2.20	0.26	0.68	1.09	5.28	3.44
Spring Center	1/2	10.34	1.22	1.10	1.52	1.26	2.64	2.16	2.38	0.26	0.68	1.09	5.28	3.44

DIRECTIONAL CONTROL VALVES

MECHANICAL OPERATORS

EK SERIES

LEVER / ROLLER / ONE-WAY LEVER ROLLER / TAPPET

3-WAY / 2-POSITION, 3-PORT

LEVER ROLLER
SPRING RETURN

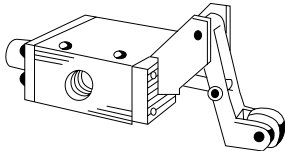

ORDER BY CATALOG NUMBER
OR ITEM CODE

Port Size	Catalog Number	Item Code
1/4	EK41DA00-KS1-KR2	75071
3/8	EK41EA00-KS1-KR2	75183

ONE-WAY LEVER ROLLER
SPRING RETURN

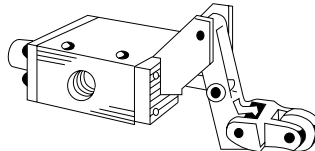

ORDER BY CATALOG NUMBER
OR ITEM CODE

Port Size	Catalog Number	Item Code
1/4	EK41DA00-KS1-KR5	75185
3/8	EK41EA00-KS1-KR5	75186

TAPPET
SPRING RETURN

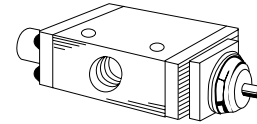

ORDER BY CATALOG NUMBER
OR ITEM CODE

Port Size	Catalog Number	Item Code
1/4	EK41DA00-KS1-KP0	75355
3/8	EK41EA00-KS1-KP0	75374

4-WAY / 2-POSITION, 5-PORT

LEVER ROLLER
SPRING RETURN

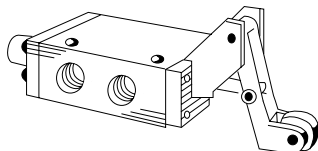

ORDER BY CATALOG NUMBER
OR ITEM CODE

Port Size	Catalog Number	Item Code
1/4	EK71DA00-KS6-KR2	75205
3/8	EK71EA00-KS6-KR2	75206
1/2	EK71FA00-KS6-KR2	79036

ONE-WAY LEVER ROLLER
SPRING RETURN

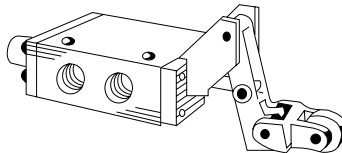

ORDER BY CATALOG NUMBER
OR ITEM CODE

Port Size	Catalog Number	Item Code
1/4	EK71DA00-KS6-KR5	75207
3/8	EK71EA00-KS6-KR5	75208
1/2	EK71FA00-KS6-KR5	79037

TAPPET
SPRING RETURN

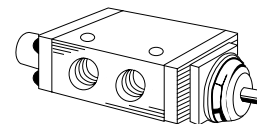

ORDER BY CATALOG NUMBER
OR ITEM CODE

Port Size	Catalog Number	Item Code
1/4	EK71DA00-KS6-KP0	74588
3/8	EK71EA00-KS6-KP0	78558
1/2	EK71FA00-KS6-KP0	79035

DIRECTIONAL CONTROL VALVES

MECHANICAL OPERATORS DIMENSIONS

EK SERIES

3-PORT

LEVER ROLLER/ONE-WAY LEVER ROLLER

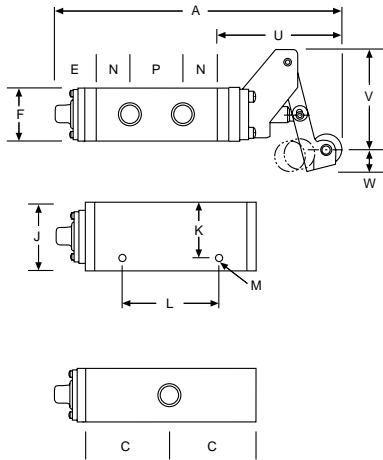

TAPPET

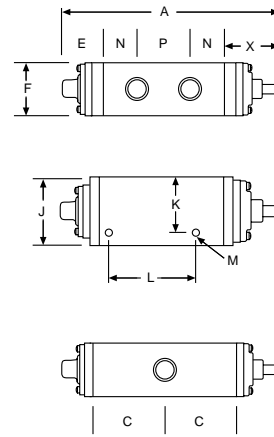

5-PORT

LEVER ROLLER/ONE-WAY LEVER ROLLER

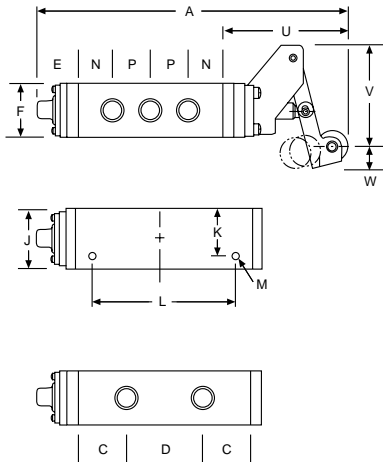

TAPPET

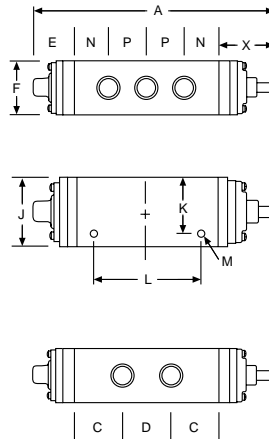

DIMENSIONS — VALVE WITH MANUAL OPERATOR — ALL DIMENSIONS IN INCHES

Operators	Port Size (PTF)	A	C	D	E	F	J	K	L	M	N	P	U	V	W	X
3-Port / 2-Position — Spring Return																
Lever Roller	1/4 & 3/8	6.05	1.24	—	1.10	1.26	2.16	1.92	1.38	0.26	0.68	1.12	2.47	2.42	.60	—
One-Way L.R.	1/4 & 3/8	7.05	1.24	—	1.10	1.26	2.16	1.92	1.38	0.26	0.68	1.12	3.47	2.45	.95	—
Tappet	1/4 & 3/8	5.03	1.24	—	1.10	1.26	2.16	1.92	1.38	0.26	0.68	1.12	—	—	—	1.45
5-Port / 2-Position — Spring Return																
Lever Roller	1/4 & 3/8	7.11	1.22	1.10	1.10	1.26	2.16	1.92	2.20	0.26	0.68	1.09	2.47	2.42	.60	—
	1/2	7.11	1.22	1.10	1.10	1.26	2.64	2.16	2.38	0.26	0.68	1.09	2.47	2.42	.60	—
One-Way L.R.	1/4 & 3/8	8.11	1.22	1.10	1.10	1.26	2.16	1.92	2.20	0.26	0.68	1.09	3.47	2.45	.95	—
	1/2	8.11	1.22	1.10	1.10	1.26	2.64	2.16	2.38	0.26	0.68	1.09	3.47	2.45	.95	—
Tappet	1/4 & 3/8	6.09	1.22	1.10	1.10	1.26	2.16	1.92	2.20	0.26	0.68	1.09	—	—	—	1.45
	1/2	6.09	1.22	1.10	1.10	1.26	2.64	2.16	2.38	0.26	0.68	1.09	—	—	—	1.45

DIRECTIONAL CONTROL VALVES

AIR VALVE SIZING

Most manufacturers catalogs give flow rating C_v for the valve which was established using NFPA standard T3.21.3. The following tables and formulas will enable you to quickly size a valve properly. The traditional, often used, approach of using the valve size equivalent to the port in the cylinder can be very costly. Cylinder speed, not port size, should be the determining factor!

The following C_v calculations are based upon simplified formulas which yield results with acceptable accuracy under the following standard condition:

Air at a temperature of 68°F

Absolute downstream or secondary pressure must be 53% of absolute inlet or primary pressure or greater. Below 53%, the air velocity may become sonic and the C_v formula does not apply. To calculate air flow to atmosphere, enter outlet pressure p_2 as 53% of absolute inlet pressure p_1 . Pressure drop Δp would be 47% of absolute inlet pressure. These valves have been calculated for a $C_v = 1$ in Table 3.

Nomenclature:

B	Pressure drop factor	
C	Compression factor	
C_v	Flow factor	
D	Cylinder Diameter	(IN)
F	Cylinder Area	(SQ IN)
L	Cylinder Stroke	(IN)
P_1	Inlet or Primary Pressure	(PSIG)
P_2	Outlet or Secondary Pressure	(PSIG)
Δp	Pressure differential ($p_1 - p_2$)	(PSID)
q	Air flow at actual condition	(CFM)
Q	Air flow of free air	(SCFM)
t	Time to complete one cylinder stroke	(SEC)
T	Absolute temperature at operating pressure. (°R)	
	Deg R = Deg F + 460	

VALVE SIZING FOR CYLINDER ACTUATION— DIRECT FORMULA

$C_v =$	cylinder area (SQ IN)	F x	cylinder stroke (IN)	L x	compression factor (see Table 2)	C
	pressure drop factor (See Table 2)		time to complete cylinder stroke (SEC)		t x 29	

Example: Cylinder size 4" Dia. x 10" stroke. Time to extend: 2 seconds. Inlet pressure 90 PSIG. Allowable pressure drop 5 PSID. Determine C_v .

Solution: Table 1 F = 12.57 SQ IN.

Table 2 C = 7.1

B = 21.6

$$C_v = \frac{12.57 \times 10 \times 7.1}{21.6 \times 2 \times 29} = .7$$

Select a valve that has a C_v factor of .7 or higher. In most cases a 1/4" valve would be sufficient. See Page 67 for C_v ratings of Boston valves.

It is considered good engineering practice to limit the pressure drop Δp to approximately 10% of primary pressure p_1 . The smaller the allowable pressure drop, the larger the required valve will become.

After the minimum required C_v has been calculated, the proper size valve can be selected from the catalog.

TABLE 1: CYLINDER PUSH BORE AREA F FOR COMMON SIZES OF CYLINDERS

Bore Size D (In.)	Push Bore* F (Sq. In.)	Bore Size D (In.)	Push Bore* F (Sq. In.)
7/16	.15	2-1/2	4.91
9/16	.25	3-1/4	8.30
3/4	.44	4	12.57
1-1/16	.89	5	19.64
1-1/4	1.23	6	28.27
1-1/2	1.77	8	50.27
2	3.14		

*See page 74 for pull bore areas.

TABLE 2: COMPRESSION FACTOR C AND PRESSURE DROP FACTOR B.

Inlet Pressure (PSIG)	Compression Factor C	Pressure Drop Factor B For Various Pressure Drops Δp				
		2 PSID	5 PSID	10 PSID	15 PSID	20 PSID
10	1.7	6.5				
20	2.4	7.8	11.8			
30	3.0	8.9	13.6	18.0		
40	3.7	9.9	15.3	20.5	23.6	
50	4.4	10.8	16.7	22.6	26.4	29.0
60	5.1	11.7	18.1	24.6	29.0	32.0
70	5.8	12.5	19.3	26.5	31.3	34.8
80	6.4	13.2	20.5	28.2	33.5	37.4
90	7.1	13.9	21.6	29.8	35.5	39.9
100	7.8	14.5	22.7	31.3	37.4	42.1
110	8.5	15.2	23.7	32.8	39.3	44.3
120	9.2	15.8	24.7	34.2	41.0	46.4
130	9.8	16.4	25.6	35.5	42.7	48.4
140	10.5	16.9	26.5	36.8	44.3	50.3
150	11.2	17.5	27.4	38.1	45.9	52.1
160	11.9	18.0	28.2	39.3	47.4	53.9
170	12.6	18.5	29.0	40.5	48.9	55.6
180	13.2	19.0	29.8	41.6	50.3	57.2
190	13.9	19.5	30.6	42.7	51.7	58.9
200	14.6	20.0	31.4	43.8	53.0	60.4
210	15.3	20.4	32.1	44.9	54.3	62.0
220	16.0	20.9	32.8	45.9	55.6	63.5
230	16.7	21.3	33.5	46.9	56.8	64.9
240	17.3	21.8	34.2	47.9	58.1	66.3
250	18.0	22.2	34.9	48.9	59.3	67.7

DIRECTIONAL CONTROL VALVES

AIR VALVE SIZING

VALVE SIZING WITH $C_v = 1$ TABLE

(For nomenclature see previous page)

This method can be used if the required air flow is known or has been calculated with the formulas as shown below.

$$1. \quad Q = .0273 \frac{D^2 L}{t} \times \frac{P_2 + 14.7}{14.7} \quad (\text{SCFM})$$

Conversion of CFM to SCFM

$$2. \quad Q = q \times \frac{P_2 + 14.7}{14.7} \times \frac{528}{T} \quad (\text{SCFM})$$

Flow Factor C_v (standard conditions)

$$3. \quad C_v = \frac{1.024 \times Q}{\Delta p \times (p_2 + 14.7)} \quad \text{NFPA Standard T3.21.3}$$

Maximum pressure drop Δp across the valve should be less than 10% of inlet pressure p_1 .

TABLE 3: AIR FLOW Q (SCFM) FOR $C_v = 1$.

Inlet Pressure (PSIG)	Air Flow Q (SCFM) For Various Pressure Drops Δp At A $C_v = 1$					Air Flow Q (SCFM) To Atmosphere
	2 PSID	5 PSID	10 PSID	15 PSID	20 PSID	
10	6.7					12.0
20	7.9	11.9				16.9
30	9.0	13.8	18.2			21.8
40	9.9	15.4	20.6	23.8		26.6
50	10.8	16.9	22.8	26.7	29.2	31.5
60	11.6	18.2	24.8	29.2	32.3	36.4
70	12.3	19.5	26.7	31.6	35.1	41.2
80	13.0	20.7	28.4	33.8	37.7	46.1
90	13.7	21.8	30.0	35.8	40.2	51.0
100	14.4	22.9	31.6	37.8	42.5	55.9
110	15.0	23.9	33.1	39.6	44.7	60.7
120	15.6	24.9	34.5	41.4	46.8	65.6
130	16.1	25.8	35.8	43.1	48.8	70.5
140	16.7	26.7	37.1	44.7	50.7	75.3
150	17.2	27.6	38.4	46.3	52.5	80.2
160	17.7	28.4	39.6	47.8	54.3	85.1
170	18.2	29.3	40.8	49.3	56.0	90.0
180	18.7	30.1	42.0	50.7	57.7	94.8
190	19.2	30.9	43.1	52.1	59.4	99.7
200	19.6	31.6	44.2	53.4	60.9	104.6
210	20.1	32.4	45.2	54.8	62.5	109.4
220	20.5	33.1	46.3	56.1	64.0	114.3
230	21.0	33.8	47.3	57.3	65.5	119.2
240	21.4	34.5	48.3	58.6	66.9	124.0
250	21.8	35.2	49.3	59.8	68.3	128.9

EXAMPLE 1: Find air flow Q(SCFM) if C_v is known. C_v (from valve catalog) = 1.8

Primary pressure $P_1 = 90$ PSIG

Pressure drop across valve $\Delta p = 5$ PSID

Flow through valve from Table 3 ($C_v = 1$) = 21.8 SCFM

$$Q = C_v \text{ of valve} \times \text{air flow at } C_v = 1 \text{ (SCFM)}$$

$$Q = 1.8 \times 21.8 = 39.2 \text{ SCFM}$$

EXAMPLE 2: Find C_v if air flow Q(SCFM) is given.

Primary pressure $P_1 = 90$ PSIG

Pressure drop $\Delta p = 10$ PSID

Air flow $Q = 60$ SCFM

Flow through valve from Table 3 ($C_v = 1$) = 30.0 SCFM

$$C_v = \frac{\text{Air Flow Q(SCFM)}}{\text{Air Flow at } C_v = 1 \text{ (SCFM)}}$$

$$C_v = \frac{60 \text{ SCFM}}{30} = 2.0$$

A valve with a minimum C_v of 2 should be selected.

EXAMPLE 3: Find C_v if air flow Q(SCFM) to atmosphere is given (from catalog).

Primary pressure $P_1 = 90$ PSIG

Air flow to atmosphere $Q = 100$ SCFM

Flow to atmosphere through valve from Table 3 ($C_v = 1$) = 51.0 SCFM

$$C_v = \frac{\text{Air Flow to atmosphere Q(SCFM)}}{\text{Air Flow to atmosphere at } C_v = 1 \text{ (SCFM)}}$$

$$C_v = \frac{100}{51} = 2.0$$

Flow given in catalog is equivalent to a valve with $C_v = 2$. This conversion is often necessary to size a valve properly, since some manufacturers do not show the standard C_v to allow a comparison.

EXAMPLE 4: Find C_v if cylinder size and stroke speed is known using the formulas 1 and 3.

Primary pressure = 90 PSIG

Pressure drop across valve 5 PSID

Cylinder size 4" DIA. x 10" Stroke

Time to complete stroke 2 sec.

$$Q = .0273 \frac{4^2 \times 10}{2} \times \frac{85 + 14.7}{14.7} = 14.81 \text{ SCFM}$$

$$C_v = \frac{1.024 \times 14.81}{5 \times (85 + 14.7)} = .7$$

VANE AIR MOTORS

1/2 TO 7-1/2 HP

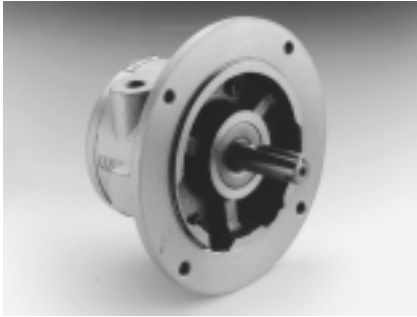

Variable speed. You can vary motor speed between 300 and 3,000 rpm with a simple valve in between the air source and air motor.

Hazardous Location. With no heat build-up, Boston Air Motors are ideal for use in flammable or explosive applications.

Instantly reversible.* A four-way valve in the air line lets you reverse the air motor. A shifting of the valve changes direction—even when the air motor is running full open, you can change motor direction with a simple movement.

Cool. As the air motor turns, expanded air cools the motor. Units can be used in ambient temperatures up to 250°F.

Little and light. Get maximum horsepower with minimum size and weight.

Little maintenance. You can put Boston Air Motors in places where they won't get much service because there's virtually nothing to service on Boston Air Motors.

Won't burn out. Boston Air Motors can be stalled or overloaded for long periods of time without damage.

No-shock starts. Because Boston Air Motors go to work with air-cushioned smoothness they cut stress on your equipment.

Self sealing vanes. Vanes self-seal and self-adjust with wear, maintaining like-new output for thousands of hours of use.

Operates in all positions. Mount them sideways, up-side-down, or in any position so long as adequate lubrication is provided and end thrust is kept to design limits.

*AXF-G counter clockwise only

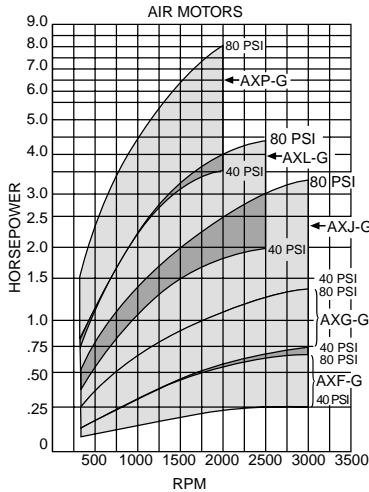

4 VANES COUNTER CLOCKWISE ROTATION

**AXF-G
1/2 HP***

*RATED AT 80 PSIG
1800 RPM

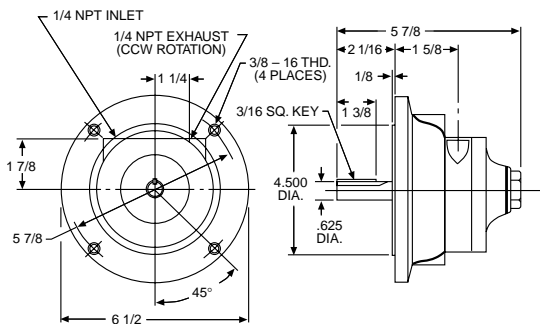

ORDER BY CATALOG NUMBER OR ITEM CODE

Catalog Number	Item Code	NEMA Mounting
AXF-G	71478	56C

RECOMMENDED ACCESSORIES

- Filter EN71221-MG (39914)
- Regulator EN72220-G (39928)
- Lubricator EN73220-MG (39923)
- FRL EN75221-MG (39872)
- Muffler EBB-2 (74517)

REPAIR KIT

- AXF-G-9001 (73855)

PERFORMANCE CHARACTERISTICS

MAXIMUM RECOMMENDED OPERATING PRESSURE: 100 PSIG
SPEED VARIATION: 300-3000 RPM

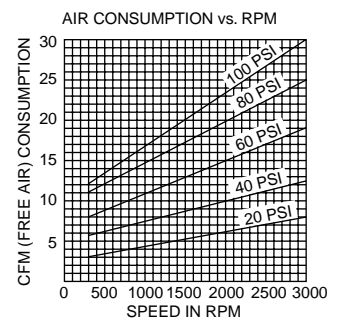
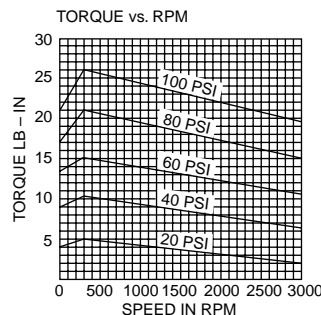

BOSTON GEAR®

VANE AIR MOTORS

4 VANES REVERSIBLE

AXG-G 1HP*

*RATED AT 80 PSIG
1800 RPM

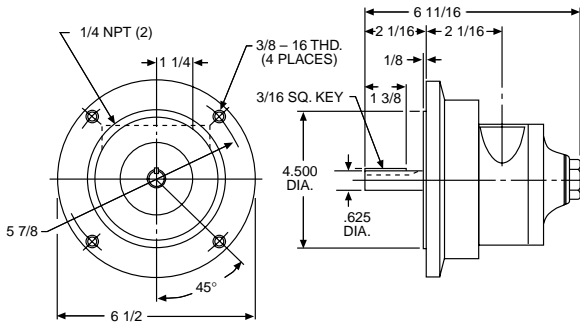

ORDER BY CATALOG NUMBER OR ITEM CODE

Catalog Number	Item Code	NEMA Mounting
AXG-G	70720	56C

PERFORMANCE CHARACTERISTICS

MAXIMUM RECOMMENDED OPERATING PRESSURE: 100 PSIG
SPEED VARIATION: 300-3000 RPM

RECOMMENDED ACCESSORIES

- Filter EN71221-MG (39914)
- Regulator EN72220-G (39928)
- Lubricator EN73220-MG (39923)
- FRL EN75221-MG (39872)
- Muffler EBB-2 (74517)

REPAIR KIT

AXG-G-9001 (73856)

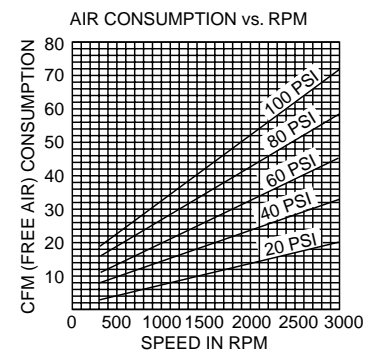
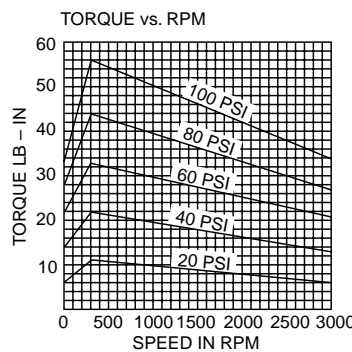

4 VANES REVERSIBLE

AXJ-G 2HP*

*RATED AT 80 PSIG
1800 RPM

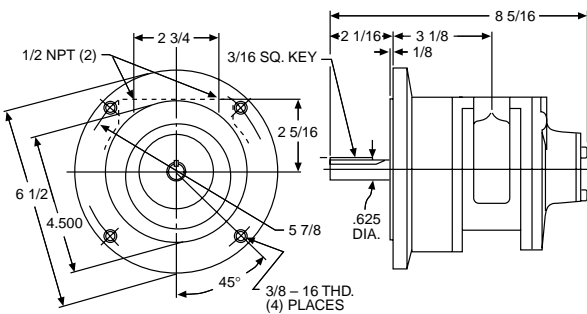

ORDER BY CATALOG NUMBER OR ITEM CODE

Catalog Number	Item Code	NEMA Mounting
AXJ-G	70721	56C

PERFORMANCE CHARACTERISTICS

MAXIMUM RECOMMENDED OPERATING PRESSURE: 100 PSIG
SPEED VARIATION: 300-3000 RPM

RECOMMENDED ACCESSORIES

- Filter EN61341-MG (70684)
- Regulator EN62340-G (70690)
- Lubricator EN63340-MG (70043)
- FRL EN65341-MG (70620)
- Muffler EBB-4 (74527)

REPAIR KIT

AXJ-G-9001 (73857)

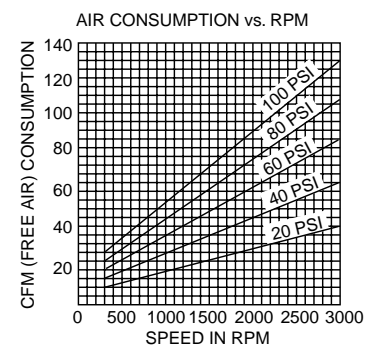
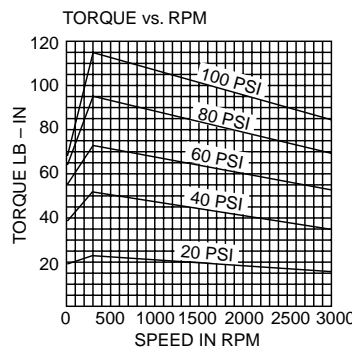

VANE AIR MOTORS

4 VANES REVERSIBLE

AXL-G 4HP

*RATED AT 80 PSIG
1800 RPM

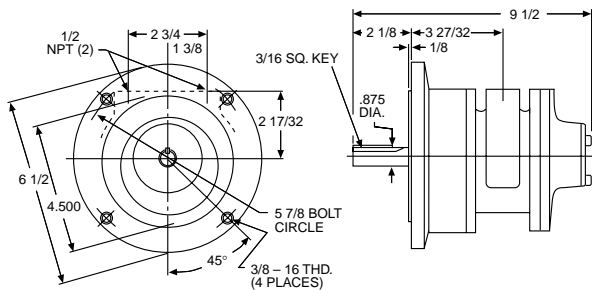

ORDER BY CATALOG NUMBER OR ITEM CODE

Catalog Number	Item Code	NEMA Mounting
AXL-G	70722	145TC

PERFORMANCE CHARACTERISTICS

MAXIMUM RECOMMENDED OPERATING PRESSURE: 100 PSIG
SPEED VARIATION: 300-2500 RPM

RECOMMENDED ACCESSORIES

- Filter EN61341-MG (70684)
- Regulator EN62340-G (70690)
- Lubricator EN63340-MG (70043)
- FRL EN65341-MG (70620)
- Muffler EBB-4 (74527)

REPAIR KIT

AXL-G-9001 (73858)

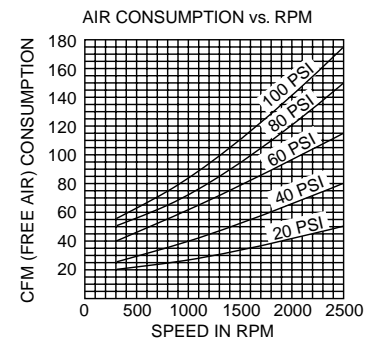
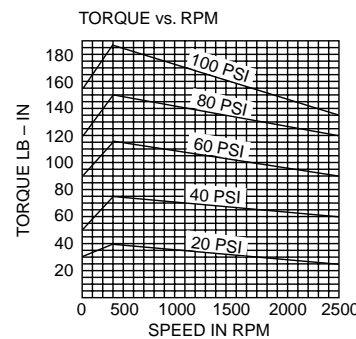

6 VANES REVERSIBLE

AXP-G 7 1/2 HP*

*RATED AT 80 PSIG
1800 RPM

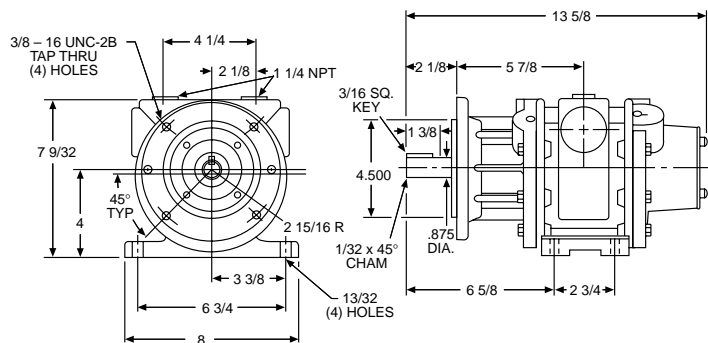

ORDER BY CATALOG NUMBER OR ITEM CODE

Catalog Number	Item Code	NEMA Mounting
AXP-G	71477	145TC

PERFORMANCE CHARACTERISTICS

MAXIMUM RECOMMENDED OPERATING PRESSURE: 100 PSIG
SPEED VARIATION: 300-2000 RPM

RECOMMENDED ACCESSORIES

- Filter EN41471-MG (73949)
- Regulator EN42470-G (74906)
- Lubricator EN43470-MG (73965)
- FRL EN45471-MG (73897)

REPAIR KIT

AXP-G-9001 (73859)

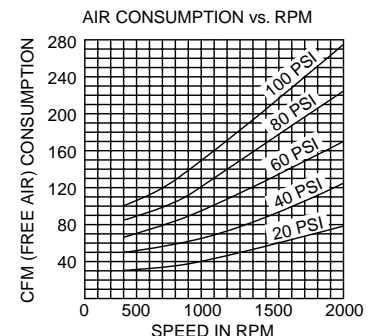
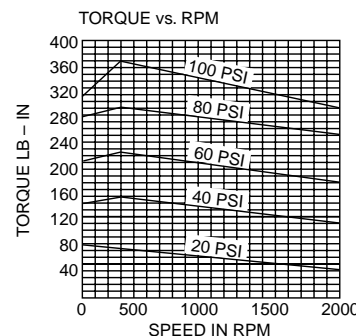

BOSTON GEAR®

QUICK EXHAUST VALVES

125 PSIG
1/8" to 3/4"



Instantaneous dumping of exhaust air permits use of smaller air valves and piping.
Increases system efficiency and cycling speeds.

The Quick Exhaust Valves provide fast dumping of exhaust air at the cylinder, eliminating the need for large selector valves ordinarily required to accommodate exhaust air moving back through the pneumatic system. Initial savings and better operating efficiency result from the use of smaller air system components. In addition, smoother, faster cylinder operation and wider application of air-powered motions are obtained.

The Quick Exhaust Valve has been designed with smooth, over-size internal passages which afford unrestricted flow and prevent clogging due to contaminated air lines. The diaphragm is an exclusive design, which assures the instantaneous and complete venting of exhaust air from cylinders, air presses and other air-operated equipment.

PRINCIPLE OF OPERATION

When air is introduced into the inlet port, the diaphragm is forced onto the exhaust seat. The outer lip of the diaphragm is deflected downward, away from the wall, allowing air to flow into the cylinder with a minimum of restriction. The diaphragm will remain on the exhaust seat as long as the inlet pressure is equal to or greater than the cylinder pressure.

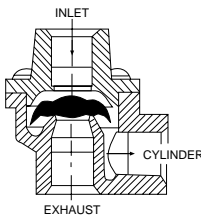

When the cylinder is fully charged and air is no longer flowing from inlet to cylinder port, the outer lip of the diaphragm will assume its normal shape and will contact the outer wall. The diaphragm will remain on the exhaust seat.

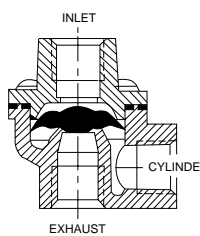

When pressure at the inlet port is vented to atmosphere (thru the control valve) the air in the cylinder, which is at a pressure level higher than atmosphere will force the diaphragm upwards to the inlet port. This will shut off the inlet port and allow air in the cylinder to flow directly to atmosphere.

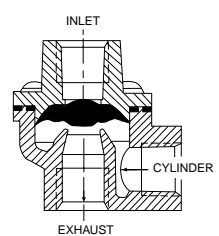

ORDER BY CATALOG NUMBER OR ITEM CODE

Catalog Number	Item Code	Inlet Port (NPT)	Inlet CV	Cylinder Port (NPT)	Exhaust Port (NPT)	Exhaust CV	Min ΔP To Shift Diaphragm (PSI)
E341	70015	1/8	0.50	1/4	1/4	1.00	5
E342	70016	1/4	1.21	1/4	3/8	1.40	8
E343	70017	3/8	2.31	3/8	3/8	2.86	8
E344	70018	1/2	3.48	1/2	3/4	5.45	3
E345	70019	3/4	5.32	3/4	3/4	7.84	3

DIMENSIONS

ΔP—Pressure differential

SPECIFICATIONS

Body Material – Die Cast Aluminum
Diaphragm – Nylon Reinforced
Buna-N (Standard)
– Viton (Optional)
Operating Pressure Range –
20-125 PSI
Operating Temperature Range –
Buna-N
–40° to 212°F
Viton –15° to 400°F

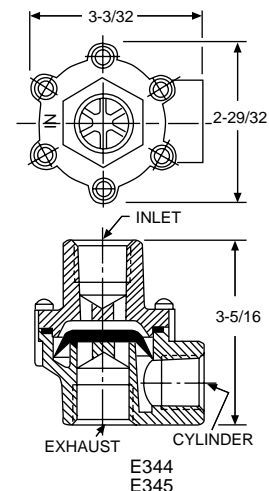
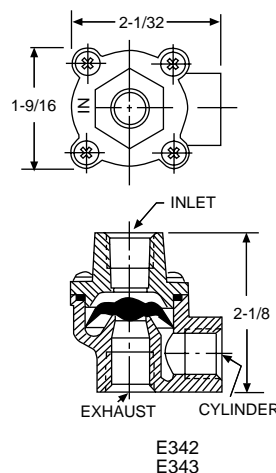
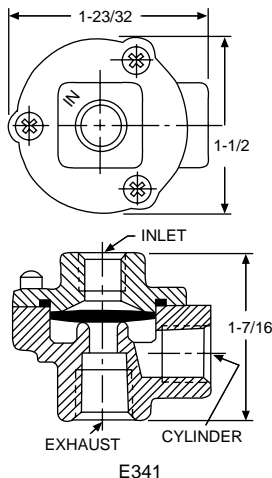

FLOW CONTROL, NEEDLE, CHECK VALVES

2000 PSI (MAXIMUM)
1/8" to 3/4" NPT



SPECIFICATIONS

Max. Operating Pressure – 2000 PSI
Operating Temperature Range – -15° to +400°F
Standard Cracking Pressure – 1 to 2.5 PSI

Materials:

- Housing – Brass
- Needle – Brass
- Washer – Teflon
- Knob – Aluminum
- Ball – Stainless Steel
- Retainer – Stainless Steel
- O-Ring – Viton

FLOW CONTROL VALVE with Free Reverse

A spring biased ball provides full flow in one direction; a tapered stainless steel needle provides a wide range of adjustment of flow in the controlled direction. A locknut prevents unwanted changes in adjustment. An aluminum knurled knob is standard.

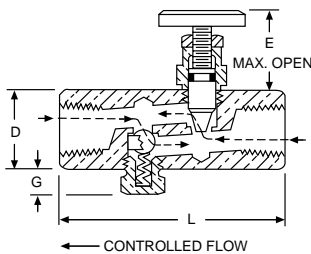

NEEDLE VALVE

A wide range of flow adjustment is possible because of the fine threaded tapered needle. Unwanted changes in adjustment are prevented by a locknut. An aluminum knurled knob is standard.

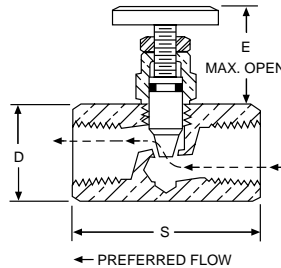

CHECK VALVE

A slight pressure differential fully opens or closes the check valve. This valve is supplied standard with a ball check.

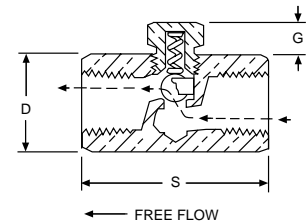

ALL DIMENSIONS IN INCHES

Size (NPTF)	D Hex	E	G	L	S
1/8	11/16	7/8	13/64	1-3/4	1-15/32
1/4	7/8	1	23/64	2-3/8	2
3/8	1-1/16	1-3/16	11/32	2-3/4	2-1/4
1/2	1-5/16	1-7/16	15/32	3-3/16	2-21/32
3/4	1-5/8	1-5/8	17/32	3-9/16	2-15/16

ORDER BY CATALOG NUMBER OR ITEM CODE

Size (NPTF)	FLOW CONTROL VALVE				NEEDLE VALVE				CHECK VALVE			
	Catalog Number	Item Code	CV	Flow (GPM)	Catalog Number	Item Code	CV	Flow (GPM)	Catalog Number	Item Code	CV	Flow (GPM)
1/8	E311	70000	.23	1.5	E321	70005	.20	3.2	E331	70010	.23	1.5
1/4	E312	70001	.54	3.0	E322	70006	.43	7.0	E332	70011	.54	3.0
3/8	E313	70002	.83	5.0	E323	70007	.78	13.5	E333	70012	.83	5.0
1/2	E314	70003	1.47	8.0	E324	70008	1.24	22.5	E334	70013	1.47	8.0
3/4	E315	70004	1.90	12.0	E325	70009	1.93	34.0	E335	70014	1.90	12.0

BOSTON GEAR®

INLINE CHECK and SHUT-OFF VALVES

INLINE CHECK VALVE

2000 PSI MAXIMUM

1/4" to 3/4" NPTF



Inline check valves fully open or close with the application of a slight differential pressure. The ball check provides full flow in one direction, yet assures a positive leak-tight seal for liquids in the other direction. A stainless steel ball check is standard.

SPECIFICATIONS

Body – Brass
 Spring – Steel
 Ball – Stainless Steel
 Standard cracking pressure 1 to 2.5 psi

ORDER BY CATALOG NUMBER OR ITEM CODE
 ALL DIMENSIONS IN INCHES

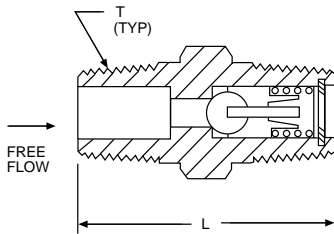

Pipe Size (NPTF)	Catalog Number	Item Code	Cv	Flow GPM	Hex	L	Maximum Operating Pressure PSI
1/4	J3320	70020	.56	2.5	5/8	1-3/8	2000
3/8	J3330	70021	1.31	6.0	3/4	1-5/8	2000
1/2	J3340	70022	2.71	10.0	7/8	2-1/16	1000
3/4	J3350	70023	3.40	15.0	1-1/8	2-1/4	1000

SHUT OFF VALVE

10,000 PSI MAXIMUM

1/4" to 1/2" NPTF



These Shut-Off Valves are ideal for use in applications requiring excellent flow characteristics as well as positive shut-off service, such as natural gas lines, chemical processing and machine tool service lines. The shut-off stem has 20 threads per inch for fast shut off. Globe type valves can be furnished for panel mounting by the use of a panel mounting nut and a washer. These valves open and close easily under pressure.

SPECIFICATIONS

Max. Operating Pressure – 10,000 PSI
 Non Shock Service
 Min. Burst Pressure – 20,000 PSI
 Operating Temperature Range – -40°F to +212°F
 Body Material – Carbon Steel
 Stem – 416 Stainless Steel
 Packing – Buna-N
 Stem Gland – Brass
 Handle – Die Casting

ORDER BY CATALOG NUMBER OR ITEM CODE
 ALL DIMENSIONS IN INCHES

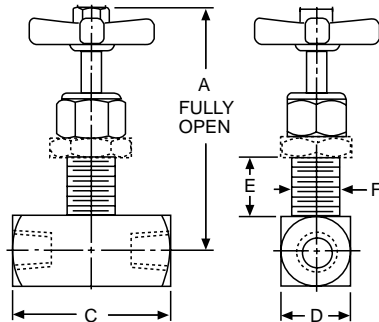

Size (NPTF)	Catalog Number	Item Code	CV*	A	C	D	E	F
1/4	J2250-2	70032	.47	3-1/16	2	7/8	3/16	3/4-20
3/8	J2250-3	70033	1.00	4-1/32	2-3/8	1	1/4	15/16-20
1/2	J2250-4	70034	1.10	3-15/16	2-7/8	1-1/4	1/4	15/16-20

*Fully Open

SHUTTLE and SLIDE VALVES

SHUTTLE VALVES 1/8" & 1/4" NPTF



The shuttle valve operates as a three way valve with two inlet ports and one outlet port. The check ball moves away from the inlet port with the greatest differential pressure and against the port having the least differential pressure.

SPECIFICATIONS

Maximum Operating Pressure (Non Shock): 200 PSI
 Material: Body: Brass
 Check Ball: Buna-N
 Temperature Range: -40° to +212°F

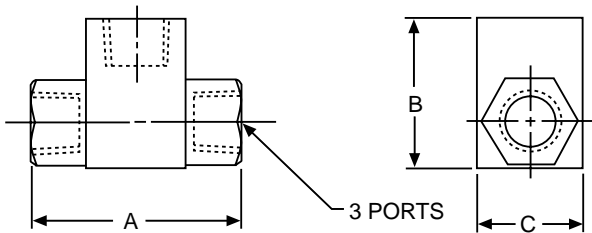

ALL DIMENSIONS IN INCHES
 ORDER BY CATALOG NUMBER OR ITEM CODE

Size (NPTF)	Catalog Number	Item Code	A	B	C	C _v
1/8	E351	74390	1-1/4	31/32	5/8	.74
1/4	E352	74391	1-7/8	1-15/16	7/8	1.35

SLIDE VALVES 1/8" to 1/2" NPTF



The slide valve is a manually operated, two position, three way valve for pneumatic applications. It permits instant gauge reading, with the gauge vented to atmosphere when the valve sleeve slides into the other position. Also ideal for applications such as air clamps and single acting cylinders.

Maximum Operating Pressure (Non Shock): 250 PSI
 Material: Body – Steel (Black Oxide)
 Sleeve – Brass
 Retaining Ring – Steel
 O-Ring – Buna-N
 Temperature Range: -40° to +212°F

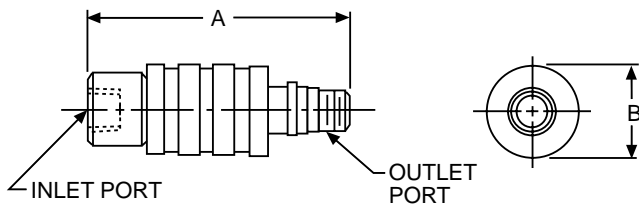

ALL DIMENSIONS IN INCHES
 ORDER BY CATALOG NUMBER OR ITEM CODE

Size (NPTF)	Catalog Number	Item Code	A	B (Dia.)	C _v
1/8	E381	74395	2-1/2	7/8	.98
1/4	E382	74396	2-3/4	1-1/8	1.53
3/8	E383	74397	2-13/16	1-1/8	1.78
1/2	E384	74398	3-3/4	1-1/2	3.26

MUFFLERS and BREATHER VENTS

MUFFLER-FILTER 1/8" to 1-1/2" NPTF



SPECIFICATIONS

Maximum Pressure: 300 PSI
Temperature Range: 40° to 300°F

Exhaust mufflers utilize porous sintered bronze (40 micron) directly bonded to copper plated steel thread pipe fittings to diffuse air and muffle noise from the exhaust ports of valves, cylinders and air tools.

These units offer a combination of small size with the greatest possible sound deadening qualities to reduce exhaust noise to acceptable levels within OSHA's noise requirements.

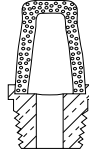

ALL DIMENSIONS IN INCHES
ORDER BY CATALOG NUMBER OR ITEM CODE

Size (NPTF)	Catalog Number	Item Code	Length	Hex
1/8	E621	70371	1-1/8	7/16
1/4	E622	70372	1-3/8	9/16
3/8	E623	70373	1-1/2	9/16
1/2	E624	70374	1-7/8	7/8
3/4	E625	70375	2-1/4	1-1/16
1	E626	70376	2-7/8	1-5/16
1-1/4	E627	70377	3-1/4	1-11/16
1-1/2	E628	70378	3-11/16	2

SPECIFICATIONS

Maximum Pressure: 300 PSI
Temperature Range: 40° to 300°F

Speed control muffler units provide an infinite variation of metering airflow at an acceptable sound level on exhaust ports of air valves with complete safety. The speed of an operating cylinder or air tool may be increased or decreased with an adjusting screw which can then be locked in place by a locknut. Objectionable exhaust air noise is eliminated by the surrounding sleeve of 40 micron sintered bronzes.

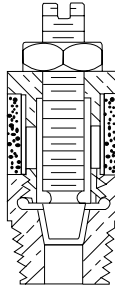

SPEED CONTROL MUFFLER 1/8" to 1" NPTF

ALL DIMENSIONS IN INCHES
ORDER BY CATALOG NUMBER OR ITEM CODE

Size (NPTF)	Catalog Number	Item Code	Length Open	Hex	Max Flow (SCFM)
1/8	E631	70418	1-5/16	1/2	20
1/4	E632	70419	1-9/16	9/16	30
3/8	E633	70420	1-5/8	11/16	40
1/2	E634	70421	2	7/8	60
3/4	E635	70422	2-3/8	1-1/16	70
1	E636	70423	2-3/8	1-5/16	100

SPECIFICATIONS

Maximum Pressure: 300 PSI
Temperature Range: 40° to 160°F

Coalescing mufflers are installed in the exhaust ports of pneumatic valves, motors and other air operated devices to reduce work area noise and oil mist from the exhaust air. In addition, they prevent contaminants from entering open exhaust ports and causing premature valve failure. Replaceable fiberglass elements are available.

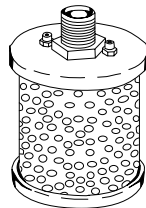

COALESCING MUFFLERS 1/2" to 1" NPTF

ALL DIMENSIONS IN INCHES
ORDER BY CATALOG NUMBER OR ITEM CODE

Size (NPTF)	Catalog Number	Item Code	C _v	Diameter	Length
1/2	EFMC-4	87419	5.2	3-7/8	6
3/4	EFMC-6	87090	9.2	3-7/8	6
1	EFMC-8	70604	15.7	3-7/8	6-3/16
Replacement Element	RCMC-468	87017			

SPECIFICATIONS

Maximum Pressure: 150 PSI
Temperature Range: 40° to 300°F

Breather vents have many applications including single acting cylinders to prevent dirt and foreign particles from entering ports opened to the atmosphere. 1/8" to 3/4" units are constructed of 40 micron sintered bronze and brass, Larger sizes use a plated steel insert.

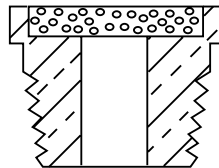

BREATHER VENT 1/8" to 1-1/2" NPTF

ALL DIMENSIONS IN INCHES
ORDER BY CATALOG NUMBER OR ITEM CODE

Size (NPTF)	Catalog Number	Item Code	Length	Hex
1/8	E641	70424	7/16	7/16
1/4	E642	70425	5/8	9/16
3/8	E643	70426	3/4	11/16
1/2	E644	70427	7/8	7/8
3/4	E645	70428	1	1-1/16
1	E646	70429	1-5/16	1-5/16
1-1/4	E647	70430	1-13/32	1-11/16
1-1/2	E648	70431	1-1/2	2

MUFFLERS and BREATHER VENTS

EXHAUST SILENCERS 1/8" to 2" NPT



**MODEL EBB
(Male Threads)**

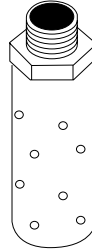

SPECIFICATIONS

Maximum Pressure: 300 PSI
Maximum Temperature: 160°F

MATERIALS:

Elements: Brass wire
Base: Aluminum
Shell: Aluminum

Exhaust Silencers installed in the exhaust ports of pneumatic valves can be a quick and inexpensive method to help reduce work area noise.

ALL DIMENSIONS IN INCHES
ORDER BY CATALOG NUMBER OR ITEM CODE

Pipe Size (NPT)	Catalog Number	Item Code	CV	Hex	Length
1/8	EBB-1	74516	1.3	13/16	2
1/4	EBB-2	74517	2.3	13/16	2-3/16
3/8	EBB-3	74519	2.9	1-1/4	3-15/32
1/2	EBB-4	74527	6.8	1-1/4	3-5/8
3/4	EBB-6	74528	7.2	2	5-3/16
1	EBB-8	74529	18.0	2	5-5/16

ALL DIMENSIONS IN INCHES
ORDER BY CATALOG NUMBER OR ITEM CODE

Pipe Size (NPT)	Catalog Number	Item Code	CV	Hex	Length
1/8	EAA-1	74504	0.8	13/16	1-11/16
1/4	EAA-2	74505	2.4	13/16	1-13/16
3/8	EAA-3	74506	5.7	1-1/4	3-1/8
1/2	EAA-4	74507	6.9	1-1/4	3-5/16
3/4	EAA-6	74508	18.0	2	4-1/2
1	EAA-8	74511	20.0	2	4-1/2
1-1/4	EAA-10	74512	42.0	2-1/2	5-9/16
1-1/2	EAA-12	74514	39.0	2-1/2	5-9/16
2	EAA-16	74515	59.0	3	6-7/16

**MODEL EAA
(Female Threads)**

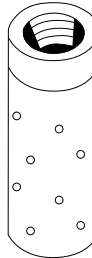

INLINE FILTER 1/8" and 1/4" NPT



SPECIFICATIONS

Maximum Pressure: 500 PSI
Temperature Range: 40° to 400°F

This pneumatic "In-Line Filter" is designed specifically for the protection of small air tools such as impact wrenches, nut runners, grinders, screw drivers and other pneumatic tools. This filter will reduce down-time and prevent costly repairs of tools in addition to extending their life.

Filter may be used for fluids such as oil, and air. Elements may be obtained in 20 and 90 micron filtrations on special order. The standard element is 40 micron filtration, which gives minimum pressure drop. All anodized aluminum housing is compact and light weight which allows it to be used directly before the air tool.

ALL DIMENSIONS IN INCHES
ORDER BY CATALOG NUMBER OR ITEM CODE

NPT Size	Catalog Number	Item Code	Overall Length	Hex
1/8	E41-9071	70782	2-3/16	3/4
1/4	E41-9072	70783	2-5/16	3/4

ORDER BY CATALOG NUMBER OR ITEM CODE

Replacement Elements	Catalog Number	Item Code
1/8 & 1/4 Filter Element 40 Micron	E41-9071-6	70784
1/8 & 1/4 Filter Element 20 Micron	E41-9071-6-20	70785
1/8 & 1/4 Filter Element 90 Micron	E41-9071-6-90	70786

NYLON TUBING and RECOILING HOSE

RECOILING HOSE ASSEMBLIES 1/4" to 3/8" DIA.



Ideally suited to supply air to Blow Guns, pneumatically powered drills, screwdrivers, Sanders, grinders or other hand held devices, this lightweight, self-retracting nylon hose automatically recoils to a fraction of its full length to keep work areas clear of bulky air lines.

Maximum working pressure is 180 psi, at room temperatures. Spring guards are provided to protect hose from kinking and associated flow restriction and hose damage.

360° swivel fittings are provided to protect hose from unnecessary twisting.

ALL DIMENSIONS IN INCHES EXCEPT AS NOTED
ORDER BY CATALOG NUMBER OR ITEM CODE

Hose I.D.	Catalog Number	Item Code	Length (Feet)	Nominal Compact Fittings (NPT)	Recommended Length	Nominal Outside Max. Work (Feet)	Coil Dia.
1/4	E50204-12	70787	12	1/4	6	10	3
	E50204-25	70788	25	MALE	12	22	
	E50204-50	70789	50		23	45	
3/8	E50206-25	70790	25	3/8	10	21	5-1/2
	E50206-50	70791	50	MALE	20	42	

REPLACEMENT FITTINGS RECOILING HOSE

360° SWIVEL FITTING

Includes: Female, Insert, Guard Spring, Nut & Swivel Body.

ORDER BY CATALOG NUMBER OR ITEM CODE

Hose I.D. (Inches)	Catalog Number	Item Code	Fittings NPT
1/4	E50204-99	70792	1/4
3/8	E50206-99	70793	3/8

NYLON TUBING 100 FOOT PACKAGES 1/8" to 1/2" DIA.

APPLICATIONS INCLUDE:

Air Logic Systems
Air, Chemical Handling and Lubricant Lines
Low Pressure Hydraulics

FLEXIBLE AND LIGHTWEIGHT
EXCELLENT DIMENSIONAL STABILITY
RESISTANT TO WIDE RANGE OF CHEMICALS
WITHSTANDS ABRASION
LOW MOISTURE ABSORPTION
TEMPERATURE RANGE – 60°F to 180°F
BURST PRESSURE (AT 75°F) 1000 PSI
O.D. TOLERANCE 1/8 : $-.005 +.003$
 BAL : $-.006 +.003$

ALL DIMENSIONS IN INCHES
ORDER BY CATALOG NUMBER OR ITEM CODE

Outside Diameter	Catalog Number	Item Code	Wall Thickness	Color	Minimum Bend Radius
1/8	E52202	70497	.016	Natural	1/2
3/16	E52203	70498	.025	Natural	3/4
3/16	E52303	70499	.025	Black	3/4
1/4	E52204	70500	.035	Natural	7/8
1/4	E52304	70501	.035	Black	7/8
3/8	E52206	70504	.050	Natural	1-1/4
3/8	E52306	70505	.050	Black	1-1/4
1/2	E52208	70506	.062	Natural	2-1/4
1/2	E52308	70507	.062	Black	2-1/4

TUBE FITTINGS

PUSH-IN TYPE
1/8" to 1/2" TUBE OD

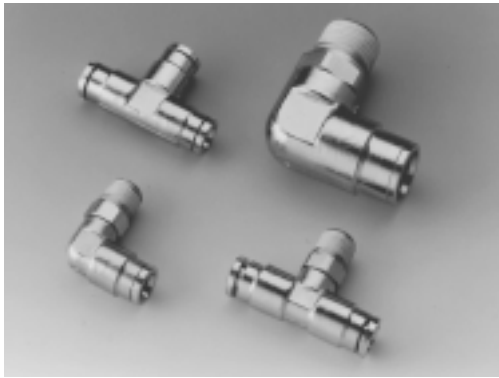

Designed for use with Nylon (see page 120) or Hytrel flexible tubing. This push-in series of fittings provides easy tube insertion, positive retention and a simple means of connecting compressed air products to system piping.

- Rated up to 270 PSIG
- Bright nickel plated
- Non-PTFE bases thread sealant
- Silicon free O-rings
- Internal hexagon

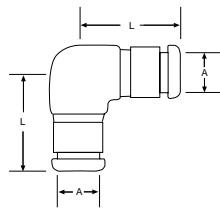

ELBOW CONNECTOR (TUBE)

ORDER BY CATALOG NUMBER
OR ITEM CODE

A Tube O.D.	Catalog Number	Item Code	L Dim.
1/8	EN51906-0202	75516	0.65
1/4	EN51906-0404	75537	0.77
3/8	EN51906-0606	75538	1.05

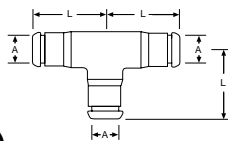

TEE CONNECTOR (TUBE)

ORDER BY CATALOG NUMBER
OR ITEM CODE

A Tube O.D.	Catalog Number	Item Code	L Dim.
1/8	EN51907-0202	75540	0.63
1/4	EN51907-0404	75541	0.77
3/8	EN51907-0606	75542	1.05

STRAIGHT MALE ADAPTER

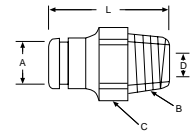

ORDER BY CATALOG NUMBER OR ITEM CODE

A Tube O.D.	B Thread NPT	Catalog Number	Item Code	C Across Flats	D Internal Hex	L Dim.
1/8	10-32*	EN51908-0200	75544	.315**	3/32	0.79
1/8	1/8	EN51908-0202	75545	7/16	3/32	0.67
1/4	1/8	EN51908-0402	75546	7/16	5/32	0.98
1/4	1/4	EN51908-0404	75547	9/16	5/32	1.11
3/8	1/4	EN51908-0604	75548	11/16	9/32	1.47
3/8	3/8	EN51908-0606	75549	11/16	5/16	1.41
1/2	3/8	EN51908-0806	75550	7/8	13/32	1.63
1/2	1/2	EN51908-0808	75551	7/8	13/32	1.70

*UNF

**DIA

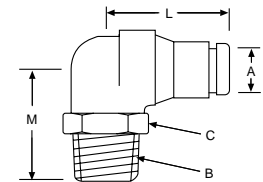

90° ELBOW, SWIVEL ADAPTER

ORDER BY CATALOG NUMBER OR ITEM CODE

A Tube O.D.	B Thread NPT	Catalog Number	Item Code	C Across Flats	L Dim.	M Dim
1/8	10-32*	EN51911-0200	75552	5/16	0.63	0.73
1/8	1/8	EN51911-0202	75554	7/16	0.63	0.82
1/4	1/8	EN51911-0402	75555	7/16	0.77	0.90
1/4	1/4	EN51911-0404	75556	9/16	0.77	1.11
3/8	1/4	EN51911-0604	75557	11/16	1.05	1.26
3/8	3/8	EN51911-0606	75558	3/4	1.05	1.26
1/2	3/8	EN51911-0806	75559	3/4	1.25	1.41
1/2	1/2	EN51911-0808	75560	7/8	1.25	1.62

*UNF

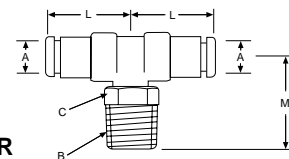

BRANCH TEE SWIVEL ADAPTER

ORDER BY CATALOG NUMBER OR ITEM CODE

A Tube O.D.	B Thread NPT	Catalog Number	Item Code	C Across Flats	L Dim.	M Dim
1/8	10-32*	EN51912-0200	75561	5/16	0.63	0.73
1/8	1/8	EN51912-0202	75568	7/16	0.63	0.81
1/4	1/8	EN51912-0402	75659	7/16	0.77	0.90
1/4	1/4	EN51912-0404	75662	9/16	0.77	1.11
3/8	1/4	EN51912-0604	75663	11/16	1.05	1.26
3/8	3/8	EN51912-0606	75664	3/4	1.05	1.26
1/2	3/8	EN51912-0806	75665	3/4	1.25	1.41
1/2	1/2	EN51912-0808	75666	7/8	1.25	1.62

*UNF

BOSTON GEAR®

BLOW GUNS

BLOW GUNS 1/4" NPT



FEATURES:

- FLOW STABILIZER VALVE for precise air control
- CONTOURED DESIGN to comfortably fit operator's hand
- CHROME PLATED, LIGHTWEIGHT ZINC BODY
- CUSHIONED THUMB LEVER
- LARGE HANGING HOOK
- MEETS OSHA REQUIREMENTS of 30 PSI maximum outlet pressure when dead-ended up to 150 PSI inlet pressure

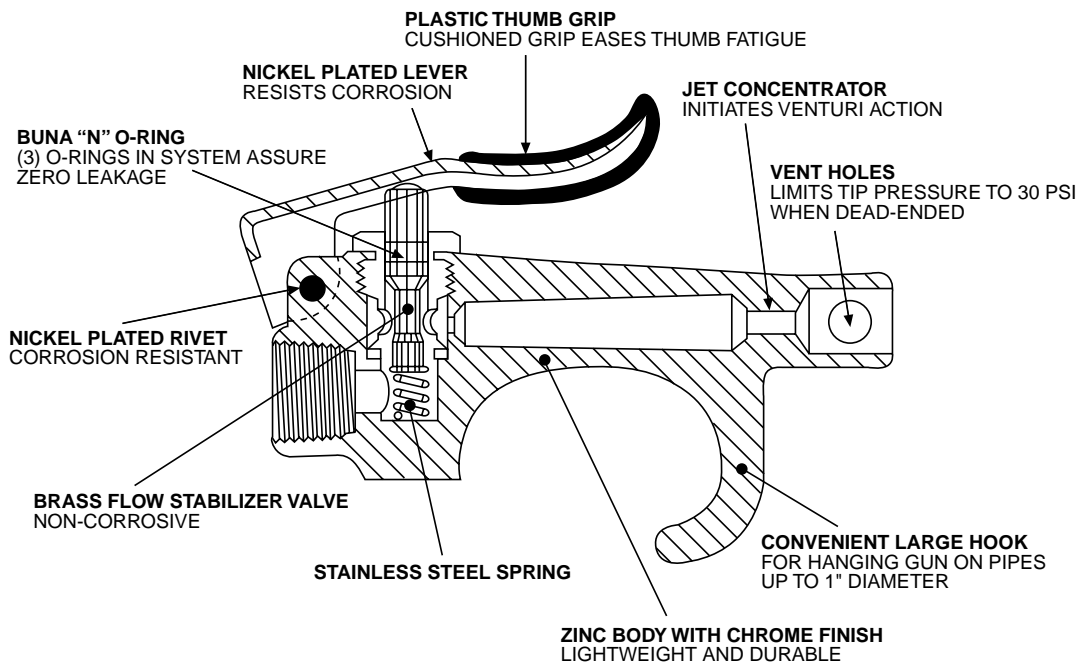

ORDER BY CATALOG NUMBER
OR ITEM NUMBER

Port NPT	Catalog Number	Item Code
Standard		
1/4	BE65A	71667
Super Booster		
1/4	BE65SB	76827

STANDARD MODEL

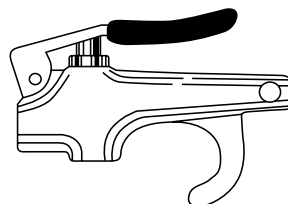

SUPER BOOSTER MODEL

High Flow at Lower Velocity

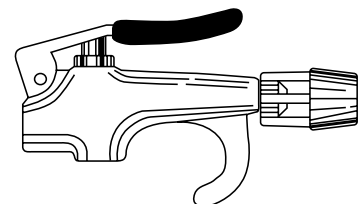

QUICK DISCONNECT COUPLING

SINGLE SHUT-OFF



Quick disconnect coupling with a shut-off valve in one half.

For applications where automatic connecting action is not required.

Rugged coupling has a simple connecting action. Pull back the sleeve, insert the plug and release sleeve.

Boston Gear's standard utility series offers all the basic features necessary for a long wearing single shut-off coupling. Ideal for any industrial type pneumatic application where quick connections and disconnections are required. Our design provides uniform 360° valve-to-lug contact for maximum air flow and extended coupling life.

Rugged steel construction features multi-ball-bearing plug latching and complete zinc chromate plating for resistance to moisture caused corrosion.

SPECIFICATIONS:

CONSTRUCTION—All steel with zinc chromate finish inside and out

SEALS— Buna-N

PRACTICAL WORKING PRESSURE— 500 PSI

BURST PRESSURE — 5000 PSI

SIZES— 1/4" and 1/2" (connection size 1/8" through 1/2")

INTERCHANGEABILITY—All couplings meet the dimensional requirements of Mil-C-4109, and are interchangeable with other couplings of the same size that meet the same military specification

SOCKETS

ORDER BY CATALOG NUMBER
OR ITEM CODE

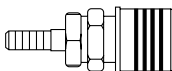
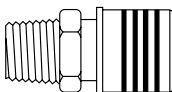
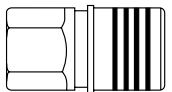

Pipe Size (NPT)	Flow (SCFM)	Catalog Number	Item Code
FEMALE PIPE THREAD			
1/8	46	E57111-02	71946
1/4	46	E57111-04	70456
3/8	46	E57111-06	71940
1/2	160	E57121-08	70462
MALE PIPE THREAD			
1/8	46	E57112-02	71947
1/4	46	E57112-04	70457
3/8	46	E57112-06	71941
1/2	160	E57122-08	70463
HOSE STEM			
1/4	46	E57113-04	70458
3/8	46	E57113-06	71942
1/2	160	E57123-08	70464

PLUGS

ORDER BY CATALOG NUMBER
OR ITEM CODE

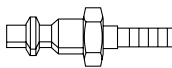
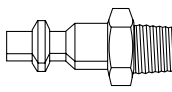
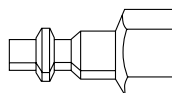

Pipe Size (NPT)	Flow (SCFM)	Catalog Number	Item Code
FEMALE PIPE THREAD			
1/8	46	E57211-02	71949
1/4	46	E57211-04	70459
3/8	46	E57211-06	71943
1/2	160	E57221-08	70465
MALE PIPE THREAD			
1/8	46	E57212-02	71948
1/4	46	E57212-04	70460
3/8	46	E57212-06	71944
1/2	160	E57222-08	70466
HOSE STEM			
1/4	46	E57213-04	70461
3/8	46	E57213-06	71945
1/2	160	E57223-08	70467

BOSTON GEAR®

SAFETY WARNINGS

AIR PREPARATION PRODUCTS

These Filter/Regulator/Lubricators are intended for use in industrial compressed air systems only. They must not be used where the pressure or temperature may exceed the maximum rated operating conditions. Before using with fluids other than air, for non-industrial applications, or for life support systems consult Boston Gear.

The polycarbonate plastic bowls used on some of these Filter/Regulator/Lubricators can be damaged and possibly burst if exposed to such substances as certain solvents, strong alkalies, compressor oils containing ester-based additives or synthetic oils. Fumes of these substances in contact with the polycarbonate bowl, externally or internally, can also result in damage. Clean with warm water only. Use a metal bowl in applications where a plastic bowl might be exposed to substances that are incompatible with the polycarbonate.

If the outlet pressures in excess of the Filter/Regulator/Lubricators pressure setting could cause downstream equipment to rupture or malfunction, install a pressure relief device downstream of the Filter/Regulator/Lubricators. The relief pressure and flow capacity of the relief device must satisfy the system requirements.

In lubrication applications, some oil mist may escape from the point of use into the surrounding atmosphere. Users are referred to OSHA Safety and Health Standards for Limiting Oil Mist Contamination and Utilization of Protecting Equipment. Through misuse, age, or malfunction, components used in fluid power systems can fail in various modes. The system designer is warned to consider the failure modes of all component parts used in the fluid power systems and to provide adequate safeguards to prevent personal injury or damage to equipment in the event of such failure modes.

System designers must provide a warning to end users in the system instruction manual if protection against a failure mode cannot be adequately provided.

System designers and end users are cautioned to review specific warnings found in the instruction sheets packed and shipped with these products.

CONTROL VALVE PRODUCTS

These products are intended for use in industrial compressed air systems only. They must not be used where pressures and temperatures can exceed those listed under Specification.

Before using these products with fluids other than those specified, for nonindustrial applications, life-support systems, or other applications not within published specifications, consult Boston Gear.

Through misuse, age, or malfunction, components used in fluid power systems can fail in various modes. The system designer is warned to consider the failure modes of all component parts used in the fluid power systems and to provide adequate safeguards to prevent personal injury or damage to equipment in the event of such failure modes. **System designers must provide a warning to end users in the system instruction manual if protection against a failure mode cannot be adequately provided.**

System designers and end users are cautioned to review specific warnings found in the instruction sheets packed and shipped with these products. System designers should also provide for all OSHA requirements including Title 29 CFR 1910.147 Lockout/Tagout.

ALTRA INDUSTRIAL MOTION

Warner Electric

Electromagnetic Clutches and Brakes - USA

South Beloit, IL
815-389-3771

For application assistance:
1-800-825-9050

Electromagnetic Clutches and Brakes - Europe

St Barthelemy d'Anjou, France
+33 (0)2 41 21 24 24

For sales office:
+33 (0)2 41 21 24 76

Precision Electric Coils and Electromagnetic Clutches and Brakes - USA

Columbia City, IN
260-244-6183

Inertia Dynamics

Spring Set Brakes; Power On and Wrap Spring Clutch/Brakes

Torrington, CT
860-482-4444

Matrix International

Electromagnetic Clutches and Brakes, Pressure Operated Clutches and Brakes

Brechin, Scotland
+44 (0) 1356 602000

U.S.
815-389-3771

Warner Linear

Linear Actuators and Guideways - USA

Belvidere, IL
815-547-1106

For application assistance:
1-800-825-9050

TB Wood's

V-Belt Drives, Synchronous Drives, Flexible Couplings, Variable Frequency AC Drives

Chambersburg, PA
717-264-7161

For assistance:
1-888-829-6637

Press #5 - Customer Service
Press #7 - Mechanical Applications
Press #8 - Electric Applications

Wichita Clutch and Industrial Clutch

Pneumatic and Oil Immersed Clutches and Brakes - USA

Wichita Falls, TX
940-723-3400

Pneumatic Clutches and Brakes - Europe

Bedford, England
+44 (0)1234 350311

Twiflex Limited

Caliper Brakes and Thrusters

Twickenham, England
+44 (0) 20 8894 1161

Formsprag Clutch

Overrunning Clutches and Holdbacks

Warren, MI 48089
586-758-5000

For application assistance:
1-800-927-3262

Marland Clutch

Roller Ramp and Sprag Type Overrunning Clutches and Backstops

Burr Ridge, IL
630-455-1752

Stieber Clutch

Overrunning Clutches and Holdbacks

Heidelberg, Germany
+49 (0)6221 30 47 0

Boston Gear

Enclosed and Open Gearing, Electrical and Mechanical P.T. Components

Charlotte, NC
704-688-7300

For customer service:
1-888-999-9860

For application assistance:
1-800-816-5608

Huco Dynatork

Precision Couplings and Air Motors

Hertford, England
+44 (0) 1992 501900
U.S.
800-825-6544

Ameridrives Couplings

Gear Couplings, Mill Spindles, Universal Joints

Erie, PA
814-480-5000

Bibby Transmissions

Disc, Gear, Grid Couplings, Overload Clutches

Dewsbury, England
+44 (0) 1924 460801

Nuttall Gear and Delroyd Worm Gear

Worm Gear and Helical Speed Reducers

Niagara Falls, NY
716-298-4100

Saftek Friction

Non-asbestos Brake and Clutch Materials

Telford, England
+44 (0) 1952 581122

Altra Industrial Motion - Asia Pacific and Africa

China	852 2615 9313
Taiwan	886 2 2577 8156
Singapore	65 6487 4464
Thailand	66 2 322 5527
Australia	612 9894 0133
S. Africa	27 11 918 4270

www.bostongear.com



Boston Gear

14 Hayward Street • Quincy, MA 02171
617-328-3300 • Fax: 617-479-6238
www.bostongear.com