

Enclosed In-Line Helical & Right Angle Helical Gear Drives

Installation and Operation

P-3010-BG
Doc. No. 65592

800B Series
800BR Series



These instructions must be read thoroughly before installing or operating speed reducers. File instructions for future reference.

CAUTION

- **For safe operation of any gear drive, all rotating shafts and auxiliary components must be shielded to conform with applicable safety standards. You must consider overall operational system safety at all times.**
- **When using a speed reducer to raise or lower a load, such as in hoisting applications, provision must be made for external braking. Under no conditions should a speed reducer be considered self-locking.**
- **Mounting of speed reducers in overhead positions may be hazardous. Use of external guides or supports is strongly recommended for overhead mounting.**

 **WARNING: Cancer and Reproductive Harm –**
www.P65Warnings.ca.gov

General Instructions

1. Align all shafts accurately. Improper alignment can result in failure. Use of flexible couplings is recommended to compensate for slight misalignment.
2. When mounting, use maximum possible bolt size and secure reducer to a rigid foundation. Periodic inspection of all bolts is recommended.
3. Arrange the drain and breather plug per your mounting position. The breather plug should also be located in the FILL position for the 850, 860, and 870 size only.
4. Auxiliary drive components (such as sprockets, gears and pulleys) should be mounted on the shafts as close as possible to the housing to minimize effects of overhung loads. Avoid force fits that might damage bearings or gears.
5. Gear drives are nameplated for 1750 RPM Input Speed and Class I Service. For lower Input Speeds and other Service Class, refer to catalog rating information.
6. Input Speeds of 1750 and lower are shown in catalog rating tables for speed reducing applications. This does not represent the maximum speed, since speed limitation is based on pitching velocity and varies with size and ratio.

Lubricant And Quantity

Klubersynth UH1 6-460 is recommended for the 800B800BR reducers and at all times, the lubricant must remain free from contamination. During the initial break-in of the gear reducer, higher than normal operating temperatures may result.

All speed reducers are supplied filled with Klubersynth UH1 6-460 synthetic oil and with the quantity listed below for standard mounting position (1) or (9) or to the mounting specified. Refer to chart below for other than standard mountings.

- Sizes 832/833B, 842/843B, 832/833BR, and 842/843BR are nonvented.
- Sizes 862/863B, 872/873B, 852/853BR and 862/863BR will require an oil change after 20,000 hours of operation. More frequent changes may be required when operating in high temperature ranges or unusually contaminated environments.
- Satisfactory performance may be obtained with nonsynthetic oils and will require more frequent changes.

Oil Capacity (Quarts)

Recommended Lubricant	Ambient Temperature	ISO Viscosity Grade No.	Boston Gear (Item Code) Quart
Klubersynth UH1 6-460	-20° to 225° F (-29° to 107°C)	460	65159
Mobile SHC634	-30° to 225° F (-34° to 107°C)	320 / 460	51493

800B Series Oil Capacity (Pints)

Unit Size	M1	M2	M3	M4	M5	M6	M7	M8	M9
832B	1.3	1.3	2.3	1.7	2.1	2.1	1.3	2.0	2.2
833B	2.8	1.7	3.0	2.6	3.6	3.2	1.7	3.0	3.3
842B	1.8	2.0	2.6	2.4	3.0	3.0	2.0	3.4	3.4
843B	3.4	3.0	3.4	3.4	4.4	3.8	3.4	4.8	4.8
862B	4.0	4.6	6.0	7.0	8.0	8.0	4.6	8.6	9.4
863B	9.0	5.8	8.0	8.8	11.0	11.0	5.8	11.0	11.0
872B	8.0	8.6	12.0	12.0	14.4	14.4	8.6	16.4	16.0
873B	16.0	11.0	14.0	14.0	19.0	19.0	11.0	19.0	19.0

800BR Series Oil Capacity (Pints)

Unit Size	M1	M2	M3	M4	M5	M6	M7	M8	M9
832BR	0.8	1.0	1.0	1.7	1.7	1.7	N/A	N/A	N/A
833BR	2.3	1.3	1.3	2.8	2.8	2.8	N/A	N/A	N/A
842BR	1.2	1.6	1.6	2.0	2.0	2.0	N/A	N/A	N/A
843BR	2.6	1.8	1.8	3.2	3.4	3.4	N/A	N/A	N/A
852BR	1.8	2.3	2.3	2.7	3.8	3.8	N/A	N/A	N/A
853BR	3.2	2.8	2.8	4.4	4.8	4.8	N/A	N/A	N/A
862BR	4.0	4.6	4.6	7.0	7.0	7.0	N/A	N/A	N/A
863BR	7.0	5.8	5.8	8.8	9.6	10.0	N/A	N/A	N/A

800B In-line Helical
 800BR Helical Worm



Scan to Watch
Replacing the Radial Lip Seal on a Boston Gear Speed Reducer.
<https://p.widencdn.net/bbgndd/V-0116-BG>

800B

Foot Mounted Horizontal 800B

Standard

M1

M2

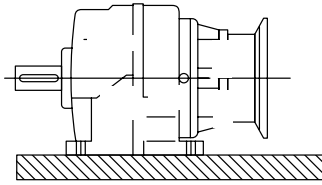
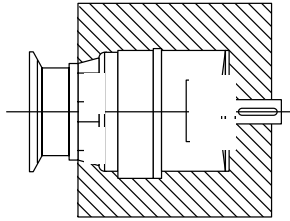

M3

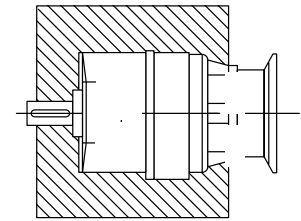

M4

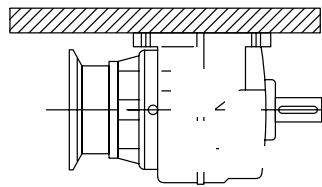

Foot Mounted Vertical 800B

M5

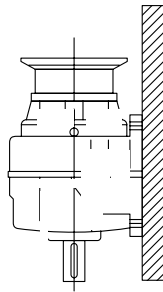

M6

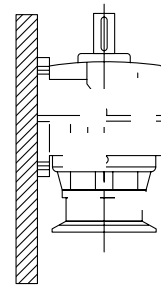

Output Flange Mounted 800BF

Standard

M7

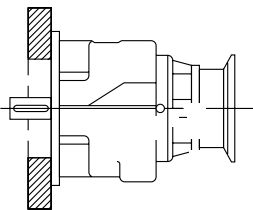

M8

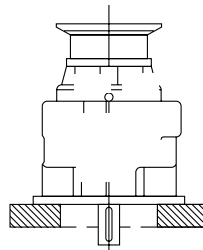

M9

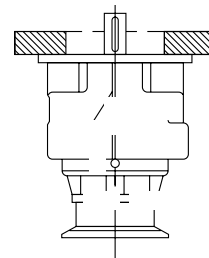

Positions M1 & M8 are standard and will be supplied with oil for this position unless otherwise specified.

Caution: Mounting of gear drives in overhead positions may be hazardous. Use of external guides or supports is strongly recommended for overhead mounting.

Avoiding those positions where the high speed oil seal is immersed in oil will provide greater security against high speed input seal wear.

Note: The above drawings will serve to represent both flanged and non-flanged styles.

800BR

Horizontal Mountings

Standard

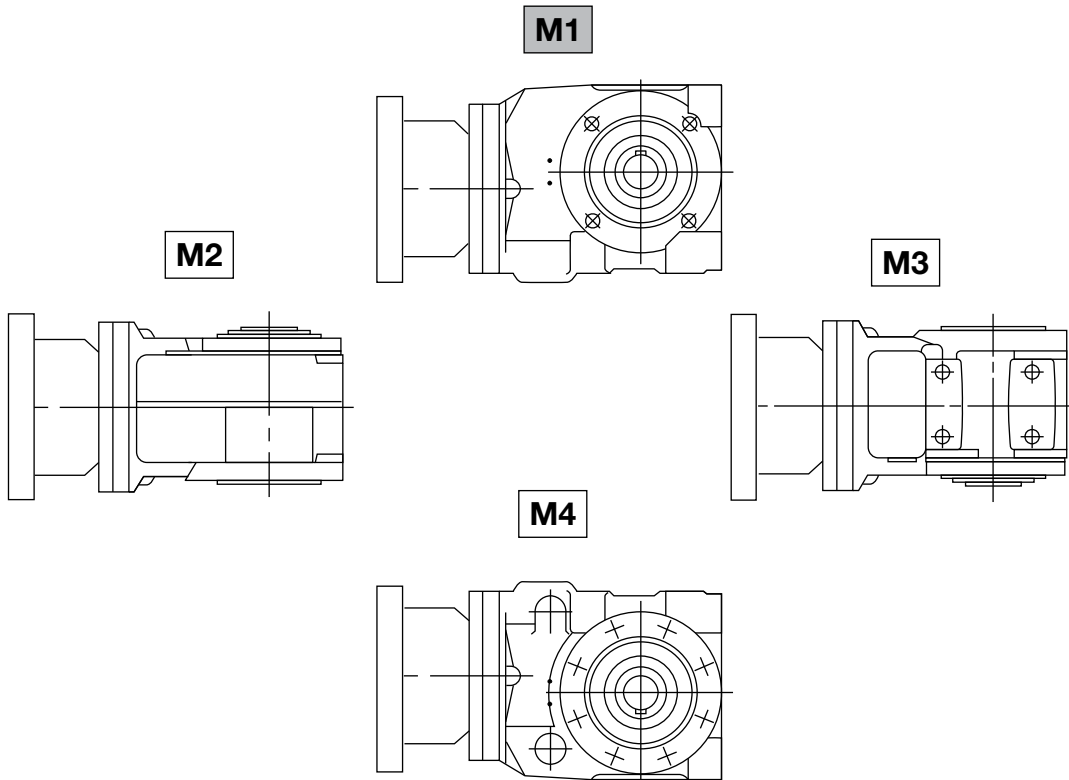

Vertical Mountings

M5

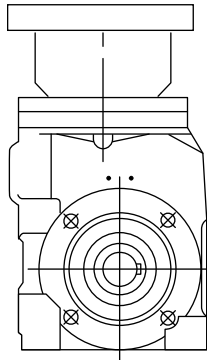

M6

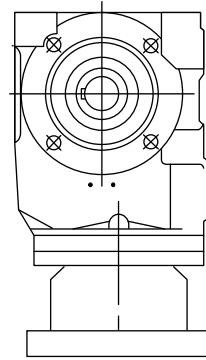

Position M1 is standard and will be supplied with oil for this position unless otherwise specified.

Caution: Mounting of gear drives in overhead positions may be hazardous. Use of external guides or supports is strongly recommended for overhead mounting. Avoiding those positions where the high speed oil seal is immersed in oil will provide greater security against high speed input seal wear.

Note: The above drawings will serve to represent both flanged and non-flanged styles.

Warranty Policy

Boston Gear warrants that products manufactured or sold by it shall be free from defects in material and workmanship. Any products which shall within two (2) years of delivery, be proved to the Company's satisfaction to have been defective at the time of delivery in these respects will be replaced or repaired by the Company at its option. Freight is the responsibility of the customer. The Company's liability under this limited warranty is limited to such replacement or repair and it shall not be held liable in any form of action for direct or consequential damages to property or person. THE FOREGOING LIMITED WARRANTY IS EXPRESSLY MADE IN LIEU OF ALL OTHER WARRANTIES WHATSOEVER, EXPRESS, IMPLIED AND STATUTORY AND INCLUDING WITHOUT LIMITATION THE IMPLIED WARRANTIES OF MERCHANTABILITY AND FITNESS.

No employee, agent, distributor, or other person is authorized to give additional warranties on behalf of Boston Gear, nor to assume for Boston Gear any other liability in connection with any of its products, except an officer of Boston Gear by a signed writing.



www.bostongear.com

701 Carrier Drive
Charlotte, NC 28216 - USA
704-588-5610