

Backstopping Clutches

FHB

Backstopping Ball Bearing Supported, Sprag Clutches



Model FHB is directly interchangeable with the older FALK® Model BIF external high-speed backstop.

Model FHB is a high speed, centrifugal throw-out (C/T) Sprag type backstop with internal sealed ball bearings. This self-contained design is completely maintenance free. It requires no re-lubrication, no external control, and no adjustment. It engages instantaneously and automatically to prevent any reverse shaft rotation. Model FHB operates at higher overrunning speeds and holds greater torque loads than competing backstops. A larger number of torque transmitting C/T Sprags reduce the hertzian contact stresses during backstopping leading to longer life than is possible with shoe designs.

Specifications

Size	Torque Capacity lb.ft. (Nm)	Overrunning Speed Inner Race RPM		Shipping Weight lb. (kg)
		Min.	Max.	
FHB-10	1,734 (2350)	400	2,400	31 (14)
FHB-20	1,734 (2350)	400	2,000	63 (29)
FHB-60	4,130 (5600)	400	1,800	158 (72)

The FHB backstop is mounted on a through-shaft with its inner race driven by a key, and its integral outer race torque arm prevented from rotating through a clearance fit interface with a fixed reaction pin. The reaction pin may also be used to provide axial restraint of the backstop on the rotating shaft. Typical uses for the Model FHB backstop include inclined conveyors, bucket elevators, and other applications where a rotating shaft must be absolutely prevented from rotating in a reverse direction, as commonly found in mining, aggregates, material handling, and other industries. The high speed capability of the unit make this backstop ideal for mounting on double extended input shafts of gear reducers. The overrunning speed of the rotating shaft should be greater than 400 RPM to assure C/T Sprag “lift-off”.

Grease Lubricated Backstops, the Model FHB is shipped from the factory lubricated for life and the ambient operating temperatures range is from -40°F (-40°C) to 150°F (65°C).

Optional OSHA cover kits are available for all three sizes. See page 123.

For further information see Service and Installation Instructions (P-222-33-FC, Bulletin 4073).

Typical Mounting Arrangements

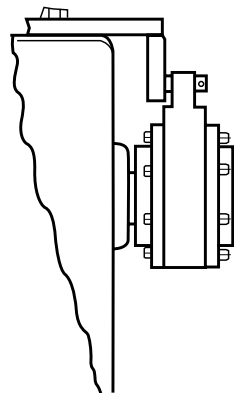

The Model FHB can be axially restrained by a cotter pin in the reaction pin

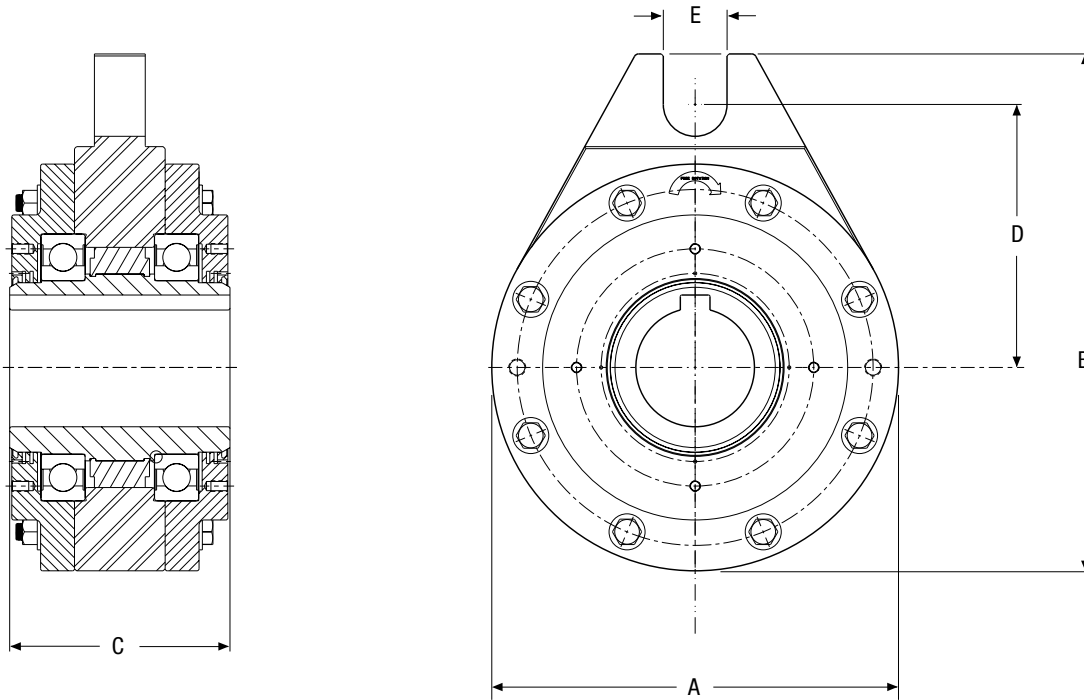

Dimensions – Formsprag FHB (mm)

Model No.	BORE		A	B	C	D	E
	Min	Max					
FHB-10	1.13 (28.70)	1.88 (47.75)	6.88 (174.75)	8.38 (212.85)	4.13 (104.90)	4.13 (104.90)	0.81 (20.5)
FHB-20	1.75 (44.45)	2.25 (57.15)	8.23 (209.04)	11.26 (286.00)	5.50 (139.70)	6.00 (152.40)	1.25 (31.75)
FHB-60	2.25 (57.15)	3.75 (95.25)	12 (304.80)	15.25 (387.35)	6.50 (165.10)	7.75 (196.85)	1.88 (47.75)

Dimensions – Falk® BIF (mm)

Model No.	BORE		A	B	C	D
	Min	Max				
10BIF	1.13 (28.70)	1.63 (41.40)	7.28 (184.91)	8.59 (218.19)	4.13 (104.90)	4.13 (104.90)
20BIF	1.75 (44.45)	2.25 (57.15)	10.28 (261.11)	12.27 (311.66)	5.50 (139.70)	6.00 (152.40)
60BIF	2.25 (57.15)	3.75 (95.25)	13.03 (330.96)	15.78 (400.81)	6.50 (165.10)	7.75 (196.85)

Bore sizes and keyseats inches (mm)

Bore Size	Bore Size	Keyseat	Bore Range	
			Min.	Max.
10	1.13 (28.58)	1/4 x 1/8	1.13 (28.7)	1.88 (47.8)
	1.25 (31.75)			
	1.50 (38.10)			
	1.56 (39.67)			
	1.63 (41.28)			
	1.75 (44.45)			
	1.79 (45.339)			
	2.00 (50.8)			
	2.13 (53.975)			
	2.25 (57.15)			
20	2.25 (57.15)		1.75 (44.5)	2.25 (57.2)
	2.38 (60.325)			
	2.50 (63.5)			
	2.75 (69.85)			
	2.94 (74.6)			
	3.00 (76.2)			
	3.25 (82.55)			
	3.50 (88.9)			
	3.75 (95.25)			
	60			