

General Purpose Clutches

SB/SBI

Overrunning, Indexing, Backstopping Ball Bearing Supported, Sprag Clutches

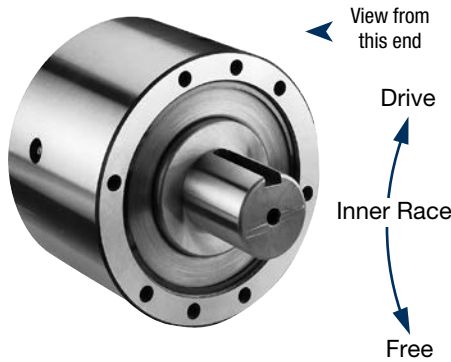

Right Hand rotation shown.
(Left Hand opposite.)

Specify direction of rotation when ordering.

Standard clutches and all C/T clutches are oil lubricated. Grease lubrication is available for applications where maintenance is inadequate, or where higher inner race overrunning speeds are required. The ground O.D. of the outer race is designed as a pilot or mounting surface for attaching parts and is concentric with the bore. Tapped holes are provided in each end of the outer race for securing these parts to the clutches. Refer to Bore Sizes/Shaft Tolerances chart for mounting data, page 128.

For vertical mounting, contact Application Engineering.

Specifications

Size	Torque Capacity* lb.ft. (Nm)	Maximum RPM								Resistance after run-in lb.ft. (Nm)	Lubrication		Shipping Weight lb. (kg)
		Standard Models				C/T Sprag Models					Oil or Grease	Oil only	
		Overrunning Speed				Overrunning Speed							
		Oil and Grease Lip Seals		Labyrinth Grease Seals		Overrunning Speed		Max. drive	Sprag lift-off		SB oz (ml)	SBI oz (ml)	
		Inner Race	Outer Race	Inner Race	Outer Race	Inner Race	Outer Race						
500	875 (1190)	2,500	800	3,000	800	2,500	4,000	1,000	1,200	.23 (.31)	.75 (22.0)	1.25 (35.0)	11.5 (5.3)
600	1,600 (2176)	2,200	750	2,400	750	2,200	3,600	1,000	1,200	.46 (.62)	1.75 (52.0)	3.00 (84.0)	21 (9.6)
700	4,000 (5440)	1,600	450	2,000	450	1,600	2,500	800	1,000	1.15 (1.56)	6.00 (168.0)	10.00 (280.0)	46 (21)
750	5,500 (7480)	1,000	650	1,800	650	1,000	1,800	650	800	3.75 (5.08)	7.00 (207.0)	13.00 (384.0)	91 (41.6)
800	10,800 (14688)	850	525	1,500	525	850	1,500	525	675	5.25 (7.12)	8.50 (251.0)	15.00 (444.0)	112 (51.2)
900	14,800 (20128)	700	500	1,350	500	700	1,350	500	650	6.25 (8.47)	11.50 (340.0)	16.00 (473.0)	171 (78.1)
1027	22,300 (30328)	500	375	1,100	375	500	1,100	375	475	10.00 (13.56)	16.00 (473.0)	32.00 (946.0)	275 (125.7)

Note: Check key and shaft stress before making final clutch selection since this may determine the maximum allowable drive torque capacity.

*Any variations to bore, key seat, shaft length, etc. may change the torque capacity.

Model SB

General purpose, ball-bearing clutches suitable for overrunning, backstopping and light to medium-duty indexing applications. They are oil lubricated and equipped with lip type seals. Grease is available. Increased speeds are possible with steel labyrinth seals.

C/T Sprag Models

C/T sprag clutches are ideal for applications with high speed outer race overrunning and low speed driving. Available with oil lubrication only.

Model SBI

Especially designed for **medium to heavy-duty** indexing applications, or applications in excess of 150 strokes/min. to provide the maximum in dependable, uniform, long life performance. They are oil lubricated and equipped with lip type seals. Grease is available.

Oil Lubricated Clutches

SB-500 through 1027 clutches are shipped from the factory with Mobil DTE Heavy Medium oil.

SBI-500 through 1027 clutches are

shipped from the factory with Mobil DTE Light oil.

Grease Lubricated Clutches

SB-500 through 1027 clutches are shipped from the factory packed with Fiske Brothers Lubriplate Low-Temp grease.

For further information, see *Installation and Maintenance Bulletin No. 2219, P-222-10 for the FSO series and No. 2213, P-222-6 for the HPI series.*

Typical Mounting Arrangement

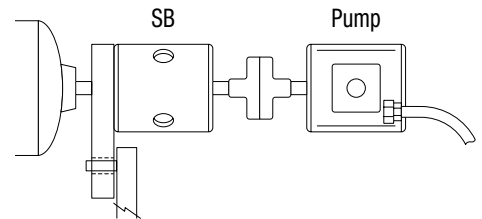

The Model SB clutches must be secured to the shaft by two set screws. For use in backstopping applications, see available torque arms on page 122. All fasteners are recommended to be grade 8 bolts.

Note: OSHA requires that a stationary guard must enclose clutches with rotating projecting parts and operating seven (7) feet or less above the floor.

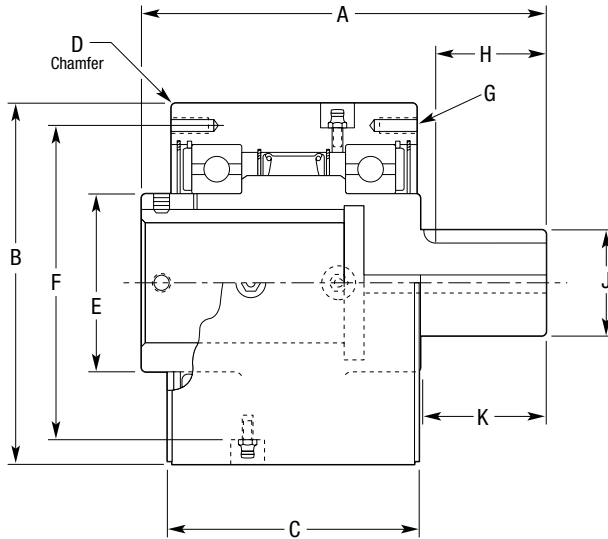

Notes:

- Angle — oil hole to mounting bolt hole
- Model 500 = 45°
- 600 = 15°
- 700 = 0° or 30° (offset from center of outer race)
- 750 = 0° or 30°
- 800 = 0° or 45°
- 900 = 0° or 18°
- 1027 = 15°

Snap ring is located on the outboard side of the oil seal on Models 600 and larger. On model 500, snap ring is inboard of the oil seal.

Dimensions inches (mm)

Size	A	B	C	D	E	F	G			H	J	K
							Number	Thread	Depth			
500	5.56 (141.22)	4.250/4.248 (107.95/107.90)	3.38 (85.85)	.06 x 45° (1.58 x 45°)	1.75 (44.45)	3.625 (92.07)	4 @ 90°	.312-24	.63 (15.87)	1.57 (39.88)	1.25 (31.75)	1.75 (44.45)
600	6.25 (158.75)	5.375/5.373 (136.53/136.47)	3.63 (92.20)	.06 x 45° (1.58 x 45°)	2.50 (63.50)	4.750 (120.65)	6 @ 60°	.312-24	.63 (15.87)	1.83 (46.48)	1.75 (44.45)	2.00 (50.80)
700	8.00 (203.20)	7.125/7.123 (180.97/180.92)	4.88 (123.95)	.06 x 45° (1.58 x 45°)	3.56 (90.42)	6.250 (158.75)	8†	.375-24	.75 (19.05)	2.33 (59.18)	2.75 (69.85)	2.50 (63.50)
750	9.75 (247.65)	8.750/8.748 (222.25/222.20)	5.88 (149.35)	.06 x 45° (1.58 x 45°)	4.25 (107.95)	7.000 (177.80)	8††	.312-24	.63 (15.87)	2.80 (71.12)	3.25 (82.55)	3.00 (76.2)
800	10.75 (273.05)	10.000/9.998 (254/253.95)	5.88 (149.35)	.06 x 45° (1.58 x 45°)	5.50 (139.70)	8.94 (227.08)	8 @ 45°			3.56 (90.42)	4.25 (107.95)	3.75 (95.25)
900	12.10 (307.34)	12.000/11.997 (304.80/304.72)	6.25 (158.75)	.06 x 45° (1.58 x 45°)	6.38 (162.05)	9.75 (247.65)	10 @ 36°			4.31 (109.47)	5.25 (133.35)	4.50 (114.30)
1027	13.38 (339.85)	15.000/14.997 (381/380.92)	6.50 (165.10)	.13 x 45° (3.30 x 45°)	9.00 (228.60)	11.75 (298.45)	12 @ 30°			5.14 (130.56)	6.25 (158.75)	5.50 (139.70)

Notes:

- † Six holes equally spaced at 60° plus two extra holes at 180°. Six hardened mounting screws are adequate for torque loads up to 3,000 lb.ft. (4068 Nm). Use eight hardened mounting screws for torque loads above these values.
- †† Six holes equally spaced at 60° plus two extra holes at 180°. Six hardened mounting screws are adequate for torque loads up to 5,100 lb.ft. (6915 Nm). Use eight hardened mounting screws for torque loads above these values.

Bore sizes and keyseats††† inches (mm)

Size	Bore Size	Keyseat	Bore Range	
			Min.	Max.
500	.875 (22.22)	3/16 x 3/32 (4.75 x 2.36)	.750 (19.05)	1.312 (33.32)
	1.312 (33.32)	1/4 x 3/32 (6.35 x 2.29)		
600	1.250 (31.75)	1/4 x 1/8 (6.35 x 3.18)	.937 (23.80)	2.250**† (57.15)
	2.000 (50.80)	3/8 x 1/8 (9.52 x 3.18)		
700	1.937 (49.20)	1/2 x 1/4 (12.70 x 6.35)		
	2.937 (74.60)	5/8 x 1/8 (15.87 x 3.18)	1.875 (47.62)	3.250**† (82.55)
	75mm	20 x 4.9mm***		
	80mm	22 x 5.4mm***		
750	2.437 (61.90)	5/8 x 5/16 (15.87 x 7.94)		
	2.500 (63.50)	5/8 x 5/16 (15.87 x 7.94)	2.250 (57.15)	3.437 (87.30)
	3.437 (87.30)	3/4 x 3/16 (19.05 x 4.75)		
800	3.000 (76.20)	3/4 x 3/8 (19.05 x 9.52)	2.625 (66.67)	4.437 (112.70)
	4.437 (112.70)	1 x 1/4 (25.40 x 6.35)		
900	100mm	28 x 6.4mm***		
	4.000 (101.60)	1 x 1/2 (25.40 x 12.70)	3.625 (92.07)	5.437 (138.10)
	5.437 (138.10)	1 x 1/4 (25.40 x 6.35)		
1027	4.937 (125.40)	1 1/4 x 5/8 (31.75 x 15.87)	4.937 (125.40)	7.000 (177.80)
	7.000 (177.80)	1 1/2 x 7/16 (38.10 x 11.10)		

- * 1/2 x 1/8 keyway.
- ** 3/4 x 1/4 keyway.
- ** For finished dimensions of keys supplied with the clutch, contact Formsprag.
- *** Contact Formsprag for keyseat information.
- † The "E" dimension is larger for this bore size.
- ††† For Bore Sizes/Shaft Tolerances, see page 128.