

# Assembly and maintenance manual

## Type RSXM85-260







Hatschekstr.36  
69126 Heidelberg  
Germany  
Phone +49(0)6221 30470  
Fax +49(0)6221 304731  
[info@stieber.de](mailto:info@stieber.de)  
[www.stieber.de](http://www.stieber.de)



Date: 20.06.2016 GB  
Revision: 0

U:\EngUsers\IProduktDoku\1AAA\_Einbauerklärung\_Montage-und Wartungsanleitung\_Konformitätserklärung\1AAA\_Montage- und Wartungsanleitungen\Original\_Worddatei\M1059E\_0\_RSXM85-260.docx

## General safety instructions

	<b>WARNING!</b>	<p><b>Risk of injury due to moving components!</b> Rotating driven components can cause the most severe injuries. Therefore, during operation:</p> <ul style="list-style-type: none"> <li>➤ It is strictly forbidden for persons to loiter in the danger zone or in its immediate vicinity</li> <li>➤ Do not disable, render unusable or circumvent safety equipment and / or safety functions</li> </ul> <p>Prior to entering the danger zone:</p> <ul style="list-style-type: none"> <li>➤ Switch off the power supply and secure it against being switched on again</li> <li>➤ Wait for lagging components to come to a standstill</li> </ul>
	<b>DANGER!</b>	<p><b>Danger due to improper operation!</b></p> <ul style="list-style-type: none"> <li>➤ Modifications to the one-way clutch are not permitted and may impair safety</li> <li>➤ All tasks may only be performed by personnel with the requisite training and expertise</li> <li>➤ Repairs and maintenance tasks may only be performed when the machine is at a standstill. To this end, the machine is to be secured against a restart</li> </ul>
	<b>WARNING!</b>	<p><b>Risk of injury due to incorrect assembly!</b> Faulty installation and maintenance can cause severe property damage and personal injury. Installation, maintenance and repair work may only be performed by personnel with the requisite training and expertise.</p>
	<b>WARNING!</b>	<p><b>Risk of injury for insufficiently qualified personnel!</b> Improper handling can cause significant personal injury and property damage. Therefore: Only ever have tasks performed by those persons to whom the tasks have been assigned.</p>

### Table of contents

Page

<b>General safety instructions .....</b>	<b>2</b>
<b>1 General.....</b>	<b>4</b>
1.1 Information relating to the assembly and maintenance manual.....	4
1.2 Explanation of symbols .....	4

1.3	Manufacturer .....	5
1.4	Labeling .....	5
1.5	Environmental protection .....	5
<b>2</b>	<b>Safety .....</b>	<b>5</b>
2.1	Intended use .....	5
2.2	Responsibility of the operator .....	6
2.3	Assembly and maintenance personnel .....	6
2.4	Personal protective equipment .....	7
2.5	Limitations of use .....	7
<b>3</b>	<b>Structure and function.....</b>	<b>8</b>
3.1	Structure .....	8
3.2	Function .....	8
<b>4</b>	<b>Transport and packaging .....</b>	<b>9</b>
<b>5</b>	<b>Storage.....</b>	<b>10</b>
5.1	Short-term storage .....	10
5.2	Long-term storage.....	11
<b>6</b>	<b>Installation .....</b>	<b>11</b>
6.1	Checking the direction of rotation .....	11
6.2	Lubrication .....	13
6.2.1	Operation with oil lubrication.....	13
6.2.2	Operation with grease lubrication .....	13
6.3	Assembly .....	14
6.4	Mounting example.....	15
<b>7</b>	<b>Maintenance .....</b>	<b>16</b>
7.1	Disassembly in case of maintenance.....	16
7.2	Test criteria in case of maintenance .....	17
7.3	Assembly in case of maintenance when using grease lubrication .....	18
7.4	Assembly in case of maintenance when using oil lubrication .....	19
<b>8</b>	<b>Disassembly .....</b>	<b>20</b>
<b>9</b>	<b>Disposal .....</b>	<b>20</b>
<b>10</b>	<b>Faults.....</b>	<b>21</b>
<b>11</b>	<b>Spare parts .....</b>	<b>21</b>

## 1 General

### 1.1 Information relating to the assembly and maintenance manual

This assembly and maintenance manual provides important information regarding the installation and commissioning of the one-way clutch.





Prerequisite for safe operation is compliance with all of the stated safety and handling instructions.

Moreover, the relevant local accident protection guidelines and general safety provisions for the field of application of the one-way clutch are to be complied with.

Read the assembly and maintenance manual carefully prior to installation and commissioning. It is a product component and must be kept in the immediate vicinity of the installation site and be accessible to personnel at all times. Furthermore, all safety instructions stated in the assembly and maintenance manual are to be observed.

### 1.2 Explanation of symbols

Warnings are marked throughout this assembly and maintenance manual by symbols. These warning symbols are introduced by signal words which indicate the extent of the danger. Comply with these warning symbols under all circumstances and act with due care and attention to avoid accidents, personal injury and property damage.

	<b>DANGER!</b>	...indicates an imminently dangerous situation which can be fatal or cause severe injuries if it is not averted.
	<b>WARNING</b>	...indicates a potentially dangerous situation which can be fatal or cause severe injuries if it is not averted.
	<b>ATTENTION</b>	...indicates a potentially dangerous situation which can cause minor or light injuries if it is not averted.
	<b>CAUTION</b>	...indicates a potentially dangerous situation which can cause property damage if it is not averted.
	<b>NOTE</b>	... highlights helpful tips and recommendations as well as information for efficient and fault-free operation.

### 1.3 Manufacturer

STIEBER GmbH, D-69126 Heidelberg, Hatschekstr. 36, Germany  
Phone +49 (0) 6221 3047-0, Fax -31

### 1.4 Labeling

Front face of the outer race

- Manufacturer's name
- Type designation
- Date of manufacture (coded)

### 1.5 Environmental protection

Energy: The one-way clutch does not use any electrical energy.

Materials: Steel

Recycling: Steel parts are up to 100% recyclable.

## 2 Safety

### 2.1 Intended use

One-way clutches of type RSXM85-260 are directional clutches, engaged and disengaged automatically, depending on the relative direction of rotation.

The torque is transmitted by a force-locking connection. They can be used as overrunning clutches or backstops in machinery and equipment.

#### Driving operation of an overrunning clutch:

When operating in torque transmission mode the driving machine element and the driven member are connected in a force-locking manner. In this operating state, a torque will be transferred.

#### Overrunning operation of an overrunning clutch:

The overrunning clutch disengages automatically when the driven member rotates faster than the driving member.

The contact-free operation will be ensured, when the driven member connected with the inner race runs above a defined speed. From this speed up the wear-free operation of all function-relevant components is guaranteed.

#### Lockout mode of a one-way clutch:

When operating in the locking direction of the one-way clutch, the machine shaft and the torque bracing to the machine element are connected in a force-locking manner.

In this operating state, a torque will be transferred.

#### Overrunning mode of a one-way clutch:

The one-way clutch disengages automatically the force-locked connection between the machine shaft and the torque bracing to the machine element, when the machine shaft runs in freewheeling direction. The contact-free operation will be ensured, when the machine shaft is rotating above a defined speed. From this speed up the wear-free operation of all function-relevant components is guaranteed.

## 2.2 Responsibility of the operator

The operator of the machine, in which the one-way clutch is installed, is subject to the legal obligations concerning occupational safety.

The valid provisions for the site of operation as well as the safety and accident prevention regulations of the trade associations are to be observed. This, in particular, means that the operator:

- is aware of the valid occupational safety provisions
- implements the necessary behavioral requirements for operation of the machine, in which the one-way clutch is installed, at the site of operation
- clearly defines responsibilities for installation, operation, maintenance and cleaning of the machine in which the one-way clutch is installed
- ensures that all staff members, who work at or with the machine in which the one-way clutch is installed, are employed and have read and understood the operating manual. Moreover, he must, at regular intervals, provide training for personnel on how to handle the machine, in which the one-way clutch is installed, and inform them of the potential dangers. In addition, the operator is responsible for ensuring that the machine in which the one-way clutch is installed:
  - is always in perfect technical condition
  - is maintained in accordance with the specified maintenance intervals
  - has all its safety equipment checked regularly for completeness and functionality

## 2.3 Assembly and maintenance personnel

	<b>WARNING</b>	<p><b>Risk of injury for insufficiently qualified personnel!</b>          Improper handling can cause significant personal injury and property damage. Therefore:</p> <ul style="list-style-type: none"> <li>➤ Only ever have tasks performed by those persons to whom the tasks have been assigned</li> </ul>
---	----------------	--

Qualified personnel are those persons who, owing to their training, experience and instruction as well as their knowledge of relevant standards, provisions, accident prevention regulations and operating conditions, have been authorized by the person responsible for the safety of the plant to perform the requisite tasks and are able to recognize and avoid potential dangers in doing so. Knowledge of first-aid measures and on-site emergency equipment must also be included.

## 2.4 Personal protective equipment

It is necessary to wear personal protective equipment when handling the machine, in which the one-way clutch is installed, to minimize health risks.

The necessary protective equipment such as work shoes, gloves, safety goggles etc. is to be put on prior to all tasks and kept on during the task.

## 2.5 Limitations of use

Type RSXM	maximum bore dia. [mm]	maximum torque [Nm]	Overrunning speeds [rpm]		maximum allowable torque transmission speed [rpm]	admissible runout (T.I.R.) outer race to shaft [mm]	admissible axial run-out outer race to shaft [mm]	Number/ size fixing screws
			min.	max.				
85	65	4700	490	6000	210	0,4	0,15	85
100	70	6100	480	4500	195	0,4	0,15	100
120	80	11600	350	4000	180	0,4	0,15	120
140	100	17400	330	3000	145	0,4	0,15	140
170	110	32000	340	2400	140	0,4	0,15	170
200	150	42000	320	2400	130	0,4	0,15	200
240	180	63000	365	1300	115	0,6	0,2	240
260	205	72000	275	1000	100	0,6	0,2	260

- Limits for ambient temperature: from  $-20^{\circ}\text{C}$  to  $+80^{\circ}\text{C}$
- Maximum operating temperature:  $90^{\circ}\text{C}$
- Overrunning: Machine shaft (inner race)
- Required machine shaft tolerance:  $d = h6$  or  $j6$
- Required tolerance outer race centering (inner diameter) :  
 $d = H6$  or  $G6$
- Oil lubrication: approved oils according Stieber catalogue / WN900
- Grease lubrication: approved greases according Stieber catalogue / WN900

## 3 Structure and function

### 3.1 Structure

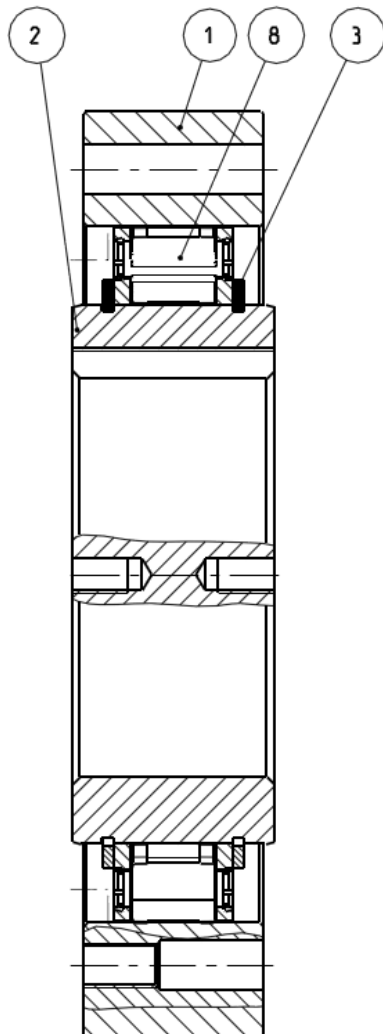

Pos. 1	Outer race
Pos. 2	Inner race
Pos. 3	Circlip
Pos. 8	Cage

Fig. 1 Structure

### 3.2 Function

When the torque is transmitted through the one-way clutch, the outer race (1) and the inner race (2) are coupled in a force-locked manner (see Fig. 2). For this purpose, clamping elements are used, the outer contours of which generates the force-locked coupling. The clamping elements are integrated into a cage (8) and are energized by springs into contact with the outer and inner race. The springs ensure rapid responding behavior of the one-way clutch at the start of torque transmission.



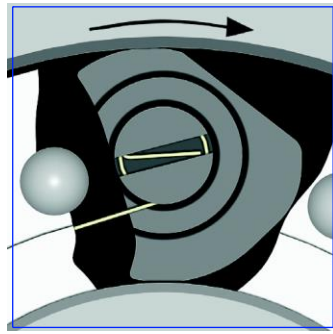

Fig.2 Torque transmission

In overrun operation, above the minimum permissible overrunning speed, the centrifugal force, in connection with the geometry of the clamping elements, generates a force which turns the clamping elements against the spring force (see Fig. 3). A contact-free position is brought about in this way so that wear-free operation of the one-way clutch can be achieved. The minimum permissible overrunning speed may only be lower for a short period during the start-up or shut-down stage otherwise the damage to the contact partner caused by wear and tear may lead to the failure of the one-way clutch.

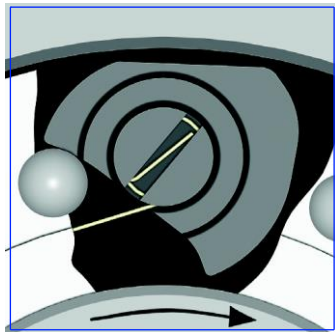

Fig.3 Contact-free position

## 4 Transport and packaging



### WARNING

#### Risk of injury due to the one-way clutch falling down or tipping over!

The weight of the one-way clutch can injure people and cause severe crushing.

Therefore:

- Use a pallet on which the one-way clutch can be moved with a forklift
- Use suitable lifting gear for lifting (slings, etc.) which is able to support the weight of the one-way clutch

**NOTE**

The local provisions regarding the disposal of transport and packaging materials are to be observed.

One-way clutches of Type RSXM85-260 are packed in air cushion foils.

All components are sent in a box on a pallet.

To prevent the component from breaking or falling apart it is secured by a transportation lock (see Figure 4).

Transport damage to the packaging and / or the one-way clutch is to be reported to the respective transit company!

The one-way clutch must be unpacked in a clean and dry environment!

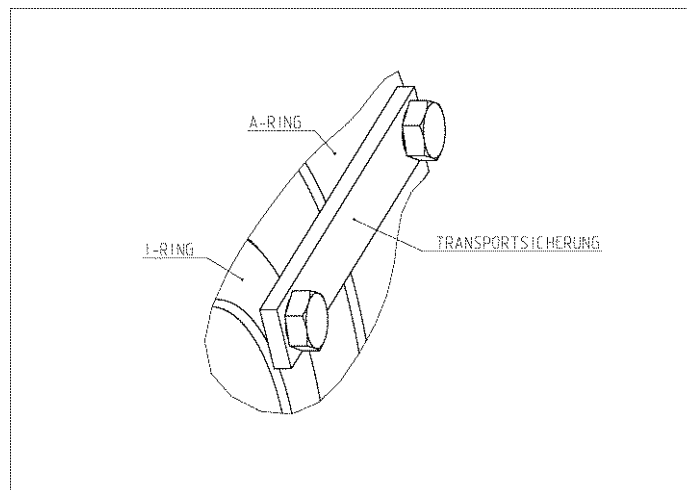

Fig. 4 Transportation lock

## 5 Storage

### 5.1 Short-term storage

One-way clutches of Type RSXM85-260 come with an oil film as corrosion protection. This corrosion protection is to be renewed at regular intervals. The frequency of these renewal intervals is dependent on the environmental conditions (temperature, moisture, salt content of the air, etc.) at the storage site.

The maximum storage period (short-term storage) is 6 months. Moreover, the one-way clutch must have long-term storage corrosion protection applied to it.

Store packages under the following conditions:

- Do not keep outdoors
- Keep dry and free from dust
- Do not expose to aggressive media

- Keep away from direct sunlight
- Avoid mechanical shocks and vibrations
- Storage temperature: -10 to +60 °C
- Relative humidity: maximum 95%, non-condensing

## 5.2 Long-term storage

To this end the one-way clutch must be welded in PE foil with desiccant agent. The corrosion protection must be checked after a period not exceeding one year or else depending on the environmental conditions (temperature, moisture, salt content of the air, etc.) at the storage site.

Store packages under the following conditions:

- Do not keep outdoors
- Keep dry and free from dust
- Do not expose to aggressive media
- Keep away from direct sunlight
- Avoid mechanical shocks and vibrations
- Storage temperature: -10 to +60 °C
- Relative humidity: maximum 95%, non-condensing

## 6 Installation

### 6.1 Checking the direction of rotation

	<b>WARNING</b>	<p><b>Risk of injury due to incorrect assembly!</b>          Faulty installation and maintenance can cause severe property damage and personal injury.          Installation, maintenance and repair work may only be performed by personnel with the requisite training and expertise.</p>
---	----------------	---

	<b>WARNING</b>	<p><b>Risk of injury due to moving components!</b>          Rotating driven components can cause the most severe injuries. Therefore, during operation:</p> <ul style="list-style-type: none"> <li>➤ It is strictly forbidden for persons to loiter in the danger zone or in its immediate vicinity</li> <li>➤ Do not disable, render unusable or circumvent safety equipment and / or safety functions</li> </ul> <p>Prior to entering the danger zone:</p> <ul style="list-style-type: none"> <li>➤ Switch off the power supply and secure it against being switched on again</li> <li>➤ Wait for lagging components to come to a standstill</li> </ul>
---	----------------	---

**CAUTION****Risk of injury due to falling components!**

The outer race or inner race can fall down if the transportation lock has been removed.  
Fasten the outer / inner race axially.

The direction of rotation at idle speed is marked as FREE on the cage (8). The direction of rotation can be changed by turning the inner race (2) including cage (8).

## Procedural steps:

- Place the one-way clutch facing upward the label "FREE" on an assembly table
- Remove the transportation lock
- Lift the inner race (2) including the cage (8) out of the outer race (1). Use appropriate lifting gear at the threaded hole of the inner race for this
- Place the inner race (2) including the cage (8) facing downwards the label "FREE" on an assembly table
- Secure (see Fig. 5 and 6) the clamp bodies in lift-off position (against the spring force) using an O-ring / cable connector as an assembly aid

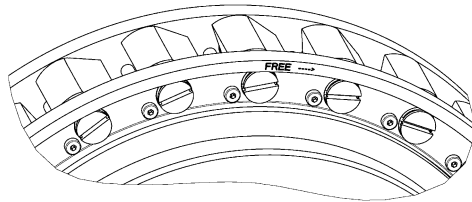

Figure 5: Clamp bodies "neutral position"

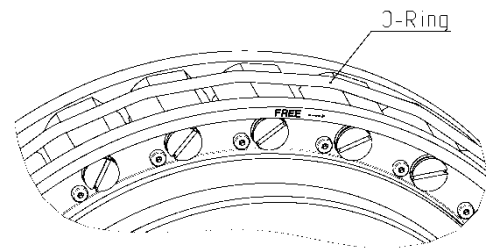

Figure 6: Clamp bodies "after lift-off"

- Insert the inner race (2) with cage (8) into the outer race (1) until half of the clamp body is covered

**NOTE**

The assembly aid (O-ring / cable connector) must be completely removed. Non-observance of this note can cause functional impairment and even failure.

- Remove the assembly aid (O-ring / cable connector) completely and lower the inner race and cage completely
- Check overrunning. The one-way clutch must be able to be turned easily in the overrun direction of rotation
- Install the transportation lock

## 6.2 Lubrication

One-way clutches of Type RSXM85-260 do not require any lubrication in overrun operation above the lift-off speed as they operate without contact.

Similarly, no lubrication is required in lockout operation as only a minimal degree of rolling motion in the clamp bodies occurs.

Additional lubrication is required if the one-way clutch runs with frequently repeated or permanent working cycles below the lift-off speed. To this end, a lubricating film, which coats the clamp bodies and tracks of the outer race, is mandatory. The lifetime is limited under these operating conditions!

### 6.2.1 Operation with oil lubrication

An oil mist is sufficient for mounting inside a gear box.

If the one-way clutch runs with frequently repeated or permanent working cycles below the lift-off speed, splash lubrication or oil supply between the cage and the outer track is necessary. The lifetime is limited under these operating conditions!

The oil volume which is necessary for splash lubrication depends on the surrounding construction.

The level should be up to a maximum of 10 mm to an inside diameter of the outer race.

### 6.2.2 Operation with grease lubrication

	<b>NOTE</b>	Excessive lubrication may negatively affect the one-way clutch functionality! Note the required grease quantities!
---	-------------	--

	<b>NOTE</b>	Unsuitable lubricants can negatively affect the one-way clutch functionality! Only use greases approved by Stieber!
---	-------------	---

Select only lubricating greases complying with product catalogue/ Stieber WN900.

Procedural steps for greasing:

- Place the one-way clutch facing upward the label "FREE" on an assembly table
- Remove the transportation lock
- Lift the inner race (2) including the cage (8) out of the outer race (1). Use appropriate lifting gear at the threaded hole of the inner race for this
- Grease the outer track with a layer thickness of approx. 1 mm
  - Use grease of NLGI class 000 to 2 with a maximum base oil viscosity of 42 mm<sup>2</sup>/s
- Secure (see Fig. 5 and 6) the clamp bodies in lift-off position (against the spring force) using an O-ring / cable connector as an assembly aid

- Insert the inner race (2) with cage (8) into the outer race (1) until half of the clamp body is covered

	<b>NOTE</b>	The assembly aid (O-ring / cable connector) must be completely removed. Non-observance of this note can cause functional impairment and even failure.
---	-------------	---

- Remove the assembly aid (O-ring / cable connector) completely and lower the inner race and cage completely
- Check overrunning. The one-way clutch must be able to be turned easily in the overrun direction of rotation
- Install the transportation lock

### 6.3 Assembly

	<b>WARNING</b>	<p><b>Risk of injury due to incorrect assembly!</b> Faulty installation and maintenance can cause severe property damage and personal injury. Installation, maintenance and repair work may only be performed by personnel with the requisite training and expertise.</p>
---	----------------	---

	<b>WARNING</b>	<p><b>Risk of injury due to moving components!</b> Rotating driven components can cause the most severe injuries. Therefore, during operation:</p> <ul style="list-style-type: none"> <li>➤ It is strictly forbidden for persons to loiter in the danger zone or in its immediate vicinity</li> <li>➤ Do not disable, render unusable or circumvent safety equipment and / or safety functions</li> </ul> <p>Prior to entering the danger zone:</p> <ul style="list-style-type: none"> <li>➤ Switch off the power supply and secure it against being switched on again</li> <li>➤ Wait for lagging components to come to a standstill</li> </ul>
---	----------------	--

	<b>CAUTION</b>	<p><b>Risk of injury due to falling components!</b> The outer race or inner race can fall down if the transportation lock has been removed. Fasten the outer / inner race axially.</p>
---	----------------	--

#### Procedural steps :

- Lift up the one-way clutch using suitable lifting gear and push it onto the oiled machine shaft
- Remove the transportation lock
- Fasten the one-way clutch axially on the machine shaft
- Center the outer race in the torque-supporting machine element

**NOTE**

Screw qualities 12.9 must not be used!

- Secure the outer race in the torque-supporting machine element with the appropriate fixing screws (e.g. as per standard DIN EN ISO 4762) and with screw quality 10.9 or 8.8; tightening torque (see Table Tightening torque)

Tightening torque [Nm]		
Size	8.8	10.9
<b>M10</b>	48	68
<b>M12</b>	84	118
<b>M16</b>	206	290
<b>M20</b>	415	592

Table: Tightening torque (according VDI 2230 Sheet1,  $\mu=0.12$  metric standard thread)

- Check overrunning. The one-way clutch must be able to be turned easily in the overrun direction of rotation

#### 6.4 Mounting example

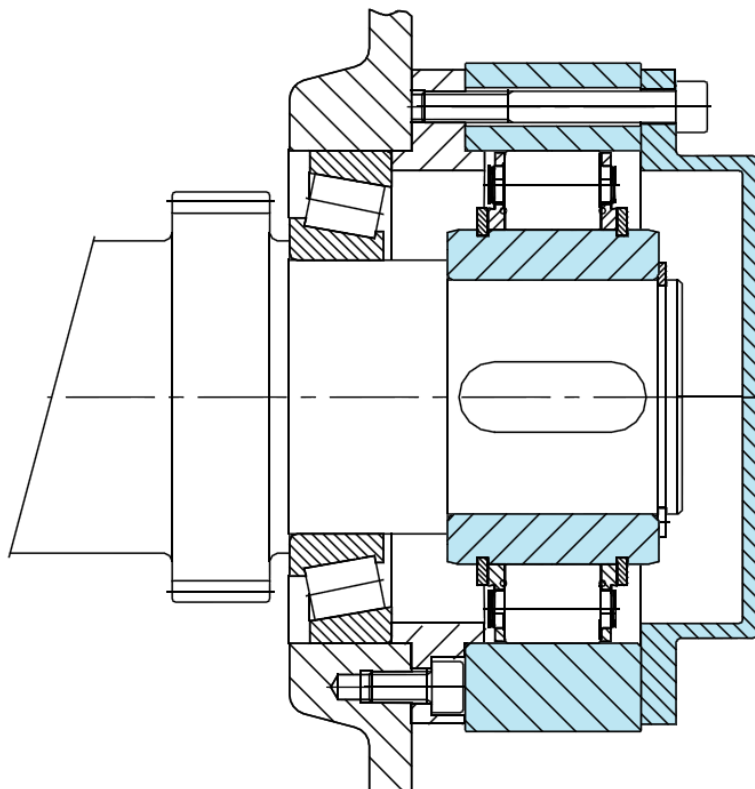





Figure 7: Mounting at the end of the shaft

## 7 Maintenance

	<p><b>WARNING</b></p>	<p><b>Risk of injury due to incorrect assembly!</b>          Faulty installation and maintenance can cause severe property damage and personal injury.          Installation, maintenance and repair work may only be performed by personnel with the requisite training and expertise.</p>
---	-----------------------	---

	<p><b>WARNING</b></p>	<p><b>Risk of injury due to moving components!</b>          Rotating driven components can cause the most severe injuries. Therefore, during operation:</p> <ul style="list-style-type: none"> <li>➤ It is strictly forbidden for persons to loiter in the danger zone or in its immediate vicinity</li> <li>➤ Do not disable, render unusable or circumvent safety equipment and / or safety functions</li> </ul> <p>Prior to entering the danger zone:</p> <ul style="list-style-type: none"> <li>➤ Switch off the power supply and secure it against being switched on again</li> <li>➤ Wait for lagging components to come to a standstill</li> </ul>
---	-----------------------	---

	<p><b>CAUTION</b></p>	<p><b>Risk of injury due to falling components!</b>          The outer race or inner race can fall down if the transportation lock has been removed.          Fasten the outer / inner race axially.</p>
---	-----------------------	--

One-way clutches of Type RSXM85-260 must be checked for damage and serviced after an operating period not exceeding 5 years.

### 7.1 Disassembly in case of maintenance

Procedural steps:

- Loosen the fastening screws of the outer race (1)
- Remove the axial retention of the inner race (2)
- Install the transportation lock

	<p><b>CAUTION</b></p>	<p><b>Risk of injury due to falling components!</b>          The outer race or inner race can fall down if the transportation lock has been removed. Therefore:</p> <ul style="list-style-type: none"> <li>➤ Install the transportation lock!</li> </ul>
---	-----------------------	--

- Pull the one-way clutch from the machine shaft. Use suitable lifting gear for this
- Place the one-way clutch facing upward the label "FREE" on an assembly table



- Remove the transportation lock
- Lift the inner race (2) including the cage (8) out of the outer race (1). Use appropriate lifting gear at the pull holes of the inner race for this
- Remove the circlip (3) of the inner race (2) and pull the cage (8) off the inner race (2)

## 7.2 Test criteria in case of maintenance

Procedural steps:

- Pre-clean the outer race (1) and cage (8) with a petroleum-based industrial cleaning agent and degrease with an acetone-based cleaning agent
- Check for damage, wear and cracks (see the testing criteria):
  - The outer race track must not exhibit any signs of damage / ruptures
  - Increased diameter due to wear in the outer race track maximum 0.1 mm compared to the area free from wear
  - Traces of deformation / indentations to the track diameters of the inner and outer race maximum 0.1 mm deep
  - Completeness of all spring elements ( 2 per clamp body)
  - Spring elements free of damage / deformation
  - Smooth rotation of the clamp bodies from stop to stop
  - Maximum width of the wear facet on the clamp bodies (see Figure 8)

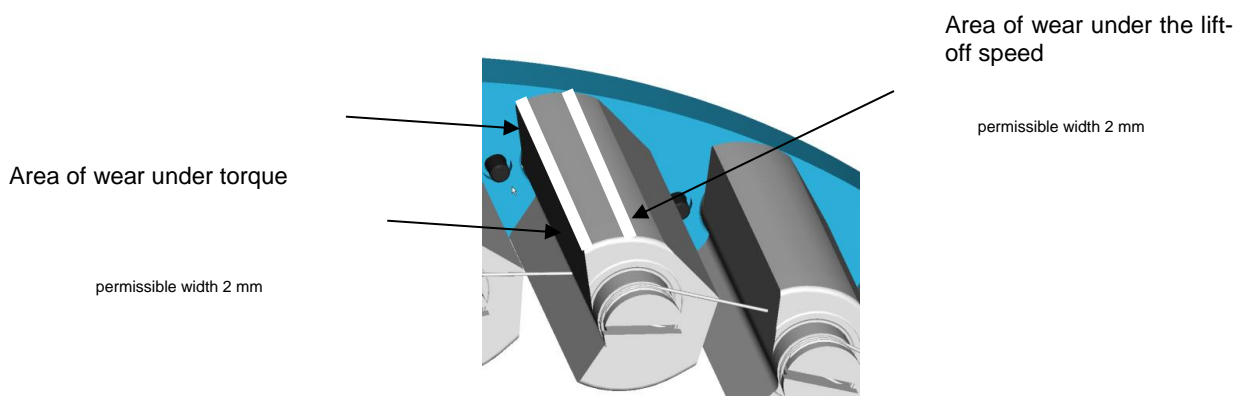

Figure 8: wear zones

- The one-way clutch can continue to be used only if all of the test criteria are met

### 7.3 Assembly in case of maintenance when using grease lubrication

Procedural steps:

- Mount the cage (8) on the inner race (2) and secure it axially using circlips (3)
- Grease the outer track with a layer thickness of approx. 1 mm
  - Use grease of NLGI class 000 to 2 with a maximum base oil viscosity of 42 mm<sup>2</sup>/s
- Secure (see Fig. 5 and 6) the clamp bodies in lift-off position (against the spring force) using an O-ring / cable connector as an assembly aid
- Insert the inner race (2) with cage (8) into the outer race (1) until half of the clamp body is covered
- Remove the assembly aid (O-ring / cable connector) completely and lower the inner race and cage completely



#### NOTE

The assembly aid (O-ring / cable connector) must be completely removed. Non-observance of this note can cause functional impairment and even failure.

- Install the transportation lock
- Lift up the one-way clutch using suitable lifting gear and push it onto the oiled machine shaft observing the overrun direction of rotation in the process
- Remove the transportation lock
- Fasten the one-way clutch axially on the machine shaft
- Center the outer race in the torque-supporting machine element



#### NOTE

Screw qualities 12.9 must not be used!

- Secure the outer race in the torque-supporting machine element with the appropriate fixing screws (e.g. as per standard DIN EN ISO 4762) and with screw quality 10.9 or 8.8; tightening torque (see Table Tightening torque)

Tightening torque [Nm]		
Size	8.8	10.9
<b>M10</b>	48	68
<b>M12</b>	84	118
<b>M16</b>	206	290
<b>M20</b>	415	592

Table: Tightening torque (according VDI 2230 Sheet1,  $\mu=0.12$  metric standard thread)

- Check overrunning. The one-way clutch must be able to be turned easily in the overrun direction of rotation

#### 7.4 Assembly in case of maintenance when using oil lubrication

Procedural steps:

- Mount the cage (8) on the inner race (2) and secure it axially using circlips (3)
- Secure (see Fig. 5 and 6) the clamp bodies in lift-off position (against the spring force) using an O-ring / cable connector as an assembly aid
- Insert the inner race (2) with cage (8) into the outer race (1) until half of the clamp body is covered
- Remove the assembly aid (O-ring / cable connector) completely and lower the inner race and cage completely.



#### NOTE

The assembly aid (O-ring / cable connector) must be completely removed. Non-observance of this note can cause functional impairment and even failure.

- Install the transportation lock
- Lift up the one-way clutch using suitable lifting gear and push it onto the oiled machine shaft observing the overrun direction of rotation in the process
- Remove the transportation lock
- Fasten the one-way clutch axially on the machine shaft
- Center the outer race in the torque-supporting machine element



#### NOTE

Screw qualities 12.9 must not be used!

- Secure the outer race in the torque-supporting machine element with the appropriate fixing screws (e.g. as per standard DIN EN ISO 4762) and with screw quality 10.9 or 8.8; tightening torque (see Table Tightening torque)

Size	Tightening torque [Nm]	
	8.8	10.9
<b>M10</b>	48	68
<b>M12</b>	84	118
<b>M16</b>	206	290
<b>M20</b>	415	592

Table: Tightening torque (according VDI 2230 Sheet1,  $\mu=0.12$  metric standard thread)

- Check overrunning. The one-way clutch must be able to be turned easily in the overrun direction of rotation

## 8 Disassembly

	<b>WARNING</b>	<b>Risk of injury due to incorrect assembly!</b> Faulty installation and maintenance can cause severe property damage and personal injury. Installation, maintenance and repair work may only be performed by personnel with the requisite training and expertise.
---	----------------	--

	<b>WARNING</b>	<b>Risk of injury due to moving components!</b> Rotating driven components can cause the most severe injuries. Therefore, during operation: <ul style="list-style-type: none"> <li>➤ It is strictly forbidden for persons to loiter in the danger zone or in its immediate vicinity</li> <li>➤ Do not disable, render unusable or circumvent safety equipment and / or safety functions</li> </ul> Prior to entering the danger zone: <ul style="list-style-type: none"> <li>➤ Switch off the power supply and secure it against being switched on again</li> <li>➤ Wait for lagging components to come to a standstill</li> </ul>
---	----------------	---

	<b>CAUTION</b>	<b>Risk of injury due to falling components!</b> The outer race or inner race can fall down if the transportation lock has been removed. Fasten the outer / inner race axially.
---	----------------	---

Procedural steps:

- Loosen the fastening screws of the outer race (1)
- Remove the axial retention of the inner race (2)
- Install the transportation lock
- Pull the one-way clutch from the machine shaft. Use suitable lifting gear for this

## 9 Disposal

	<b>NOTE</b>	The local provisions regarding the disposal of metallic components and any lubricants present are to be observed.
---	-------------	---

The one-way clutch is comprised of metallic materials which are coated with grease or oil. Metallic materials are fully recyclable. Lubricants and anticorrosive agents are to be disposed of separately. The local disposal provisions are to be observed in this regard.

## 10 Faults

The manufacturer is to be contacted immediately should any faults arise.

STIEBER GMBH, D-69126 Heidelberg, Hatschekstr. 36, Germany  
Phone +49 (0) 6221 3047-0, Fax -31

## 11 Spare parts



### WARNING

#### **Risk of injury due to incorrect spare parts!**

Incorrect or faulty spare parts can cause damage, malfunctions or total failure as well as impair safety. Therefore:

- Only use original spare parts from the manufacturer

Procure spare parts only from authorized dealers or from the manufacturer directly.