

Clutches and Brakes for Energy Efficient Drives with high Standards

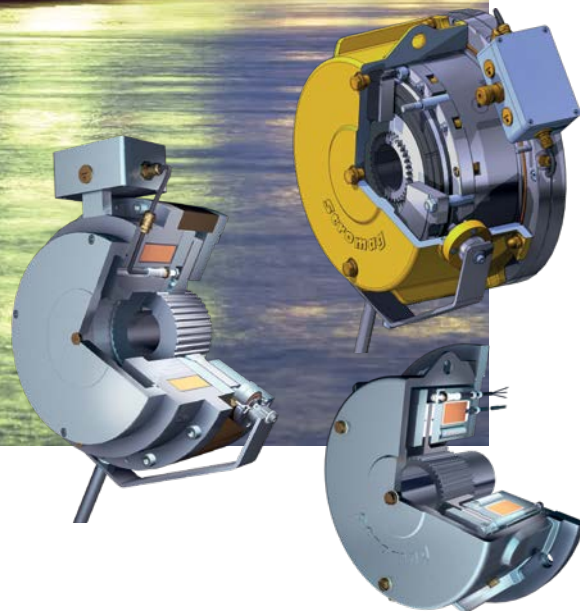

Stromag

Founded in 1932, Stromag has grown to become a globally recognized leader in the development and manufacture of innovative power transmission components for industrial drivetrain applications. Stromag engineers utilize the latest design technologies and materials to provide creative, energy-efficient solutions that meet their customer's most challenging requirements.

Stromag's extensive product range includes flexible couplings, disc brakes, limit switches, an array of hydraulically, pneumatically, and electrically actuated brakes, and a complete line of electric, hydraulic and pneumatic clutches.

Stromag engineered solutions improve drivetrain performance in a variety of key markets including energy, off-highway, metals, marine, transportation, printing, textiles, and material handling on applications such as wind turbines, conveyor systems, rolling mills, agriculture and construction machinery, municipal vehicles, forklifts, cranes, presses, deck winches, diesel engines, gensets and stage machinery.



VISIT US ON THE WEB AT STROMAG.COM

Altra Industrial Motion

Altra is a leading global designer and manufacturer of quality power transmission and motion control products utilized on a wide variety of industrial drivetrain applications. Altra clutches and brakes, couplings, gearing and PT component product lines are marketed under the industries most well known manufacturing brands. Each brand is committed to the guiding principles of operational excellence, continuous improvement and customer satisfaction. Highly-engineered Altra solutions are sold in over 70 countries and utilized in a variety of major industrial markets, including food processing, material handling, packaging machinery, mining, energy, automotive, primary metals, turf and garden and many others.

Altra's leading brands include **Ameridrives**, **Bauer** Gear Motor, **Bibby** Turboflex, **Boston** Gear, **Delroyd** Worm Gear, **Formsprag** Clutch, **Guardian** Couplings, **Huco**, **Industrial** Clutch, **Inertia** Dynamics, **Kilian**, **Lamiflex** Couplings, **Marland** Clutch, **Matrix**, **Nuttall** Gear, **Stieber**, **Stromag**, **Svendborg** Brakes, **TB Wood's**, **Twiflex**, **Warner** Electric, **Warner** Linear and **Wichita** Clutch.

VISIT US ON THE WEB AT ALTRAMOTION.COM

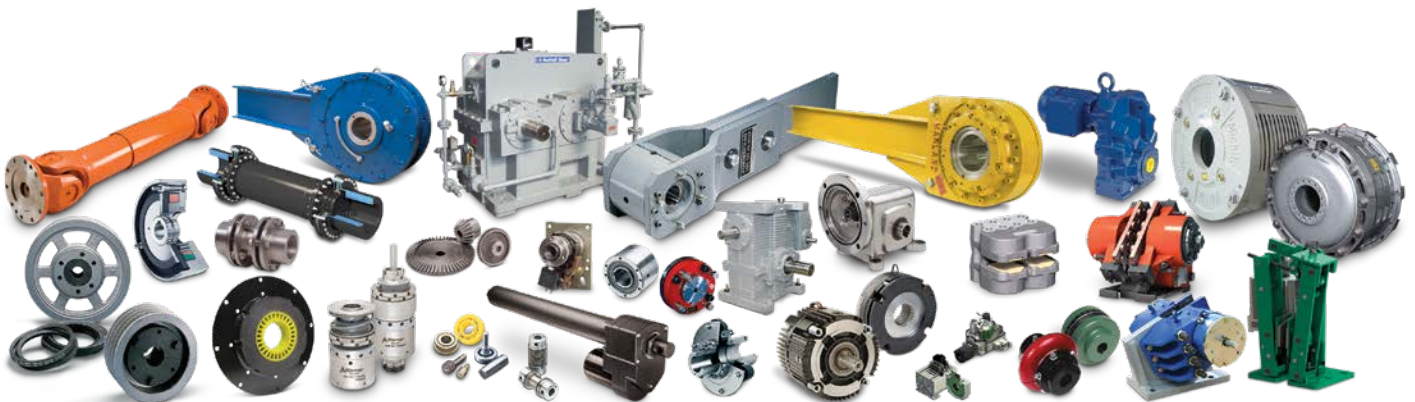

POLE-FACE FRICTION CLUTCH MWU

for the powerful actuation of auxiliary power generating sets in vehicles, general mechanical engineering

Features:

The growing integration of different drive forms in drive trains (hybrid technologies) and the development of low-consumption drives require the activation and deactivation of diverse subassemblies. They also require clutches with low consumption and an excellent torque to space ratio that can disengage quasi free from residual torque.

Applications:

Actuation of auxiliary power generating sets in agricultural machinery, municipal vehicles, textil machines, for compressor drives for refrigeration sets, booster sets in motor vehicles, laundry machines, proof systems.



Benefits include

- Torque: 400 – 7800 Nm
- Available in various executions e.g. flange-shaft, shaft-shaft and for through shaft arrangement
- Variety of designs e.g. for reception of a pump, with plug-in shaft and drive pulley with inbuilt bearings, connection for cardan shaft
- Combination variant with elastic coupling
- Electromagnetically operated for clean, simple actuation
- Four-pole technology for high power density
- High switching frequency
- Short switching times
- Fixed and wear free power transmission without slip ring
- Diaphragm technology for torque transmission free from backlash and disengagement free from residual torque
- Low idling torque
- Diaphragms for low axial restoring forces
- Steel-steel friction combination, hardened for high wear resistance

POLE-FACE FRICTION CLUTCH MFT

standard clutch solution for engagement of industrial drives

Benefits include

- Torque: 7 – 1000 Nm
- Electromagnetically operated for clean, simple actuation
- Four-pole technology for high power density
- Small dimensions
- Additional hub as option
- High switching frequency
- Fixed and wear free power transmission without slip ring
- Short switching times
- Diaphragm technology for torque transmission free from backlash and disengagement free from residual torque
- Low idling torque
- Diaphragms for low axial restoring forces
- Steel-steel friction combination, hardened for high wear resistance

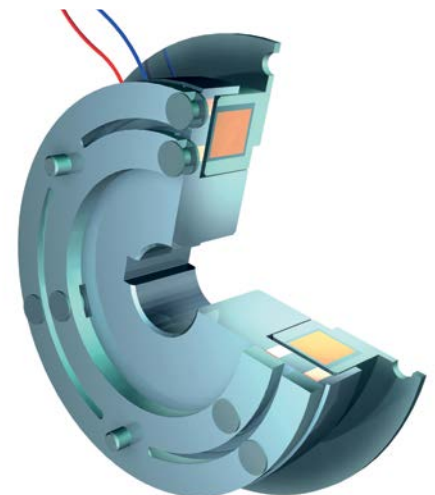

SPRING-APPLIED BRAKE 4BZFM

for offshore and marine application, flood- and seawater-proof

Features:

The 4BZFM brake type with its very high degree of protection fulfils the highest requirements for durability, robustness and seawater resistance.

Applications:

Offshore on deck motor winches, anchor windlasses, deck cranes, cargo winches and trawler winches; in rolling mills, steel mills and mining under difficult climatic conditions.

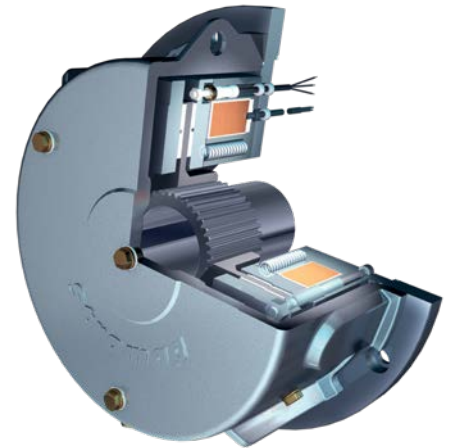

Benefits include

- Braking torque range 63 – 11,000 Nm (higher on request)
- Degree of protection up to IP 67
- All components with special surface protection
- Type approvals: GL, LRS, ABS, DNV, BV, RR (on request)
- Simple mounting, highly serviceable, fully functional without cover
- Connecting flanges to IEC standards
- Robust, reliable design with low inertia
- Braking does not generate any additional axial or radial forces
- Excellent heat dissipation
- Wide range of options like tachometer mounting, terminal box, anticondensation heater, micro switches to monitor switching states and/or wear indication
- Rectifiers and quick switching units optimise switching comfort

SPRING-APPLIED BRAKE NFF4F-LS

for slow-running high torque drivelines, in harsh environment

Features:

The four-face brake range has been developed for industrial and crane applications requiring for slow running drives a very high brake torque with closed design.

Applications:

Cranes, conveyors, assembling lines, presses with electric torque motor drives, electric gearless drives and heavy industry.

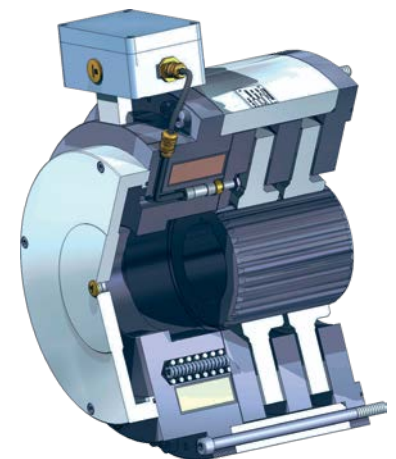

Benefits include

- Comprehensive brake torque range 4,000 – 40,000 Nm
- Degree of protection up to IP 66
- All components with special surface protection
- Concentricity through body for tacho fixing
- Simple mounting, no brake disassembly required
- Extremely low inertia
- High heat dissipation

SPRING-APPLIED BRAKE NFF

for compact industrial and crane applications with a high protection against harsh environment

Features:

With its high degree of protection the brake fulfils the highest requirements for durability and robustness.

Applications:

On harbour and marine cranes, in container transportation plant, for long travel drives, hoisting and trolley travel gears, suitable for seawater environment and similar harsh environments.

Benefits include

- Braking torque range 20 – 10,000 Nm (higher on request)
- Degree of protection up to IP 66
- All components with special surface protection
- Type approval: GL
- Simple mounting, no brake disassembly required
- Braking does not generate any additional axial or radial forces.
- Excellent heat dissipation
- Wide range of options like braking torque adjustment, manual release, tachometer mounting, terminal box, anticondensation heater, micro switches to monitor switching states and/or wear indication
- Rectifiers and quick switching units optimise switching comfort
- Robust, reliable design with low inertia



SPRING-APPLIED BRAKE BZFM V7

for standard electric motors, general industrial applications

Features:

Completely pre-mounted and adjusted the brake fulfils highest requirements for a high heat capacity and less wear.

Applications:

Brake series for mounting at electric motors in general machinery, wind turbine generator systems and conveyor technology.

Benefits include

- Braking torque range 3 – 380 Nm
- Degree of protection up to IP 44 with rubber sleeve and seal ring on through shaft
- Simple mounting, no brake disassembly required
- The fitted friction pads present an intermittent friction surface for good heat dissipation
- Axially flexible friction pads in the carrier allow high fastening tolerances
- Fitted as standard with a manual release for simple retrofits
- Compact, simple design, standard brake for wide range of applications
- Adjusting ring fitted as standard for simple torque reduction up to 55 % of the rated torque

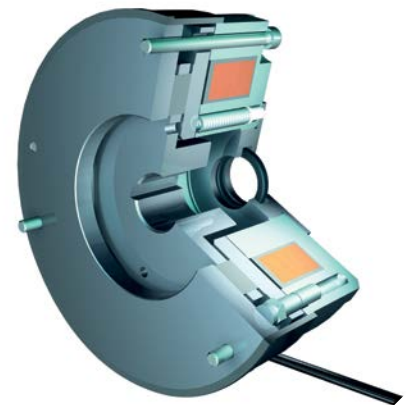

SPRING-APPLIED BRAKE HPI

for industrial and crane applications with a very high protection against harsh environment

Features:

With a compact design and a high wear-resistance the brake assures a high durability.

Applications:

Holding and working brake variations for industrial applications where high protection against harsh environment is essential. For drives for port cranes and heavy machinery e.g. coal mining, steel plants and rolling mills.

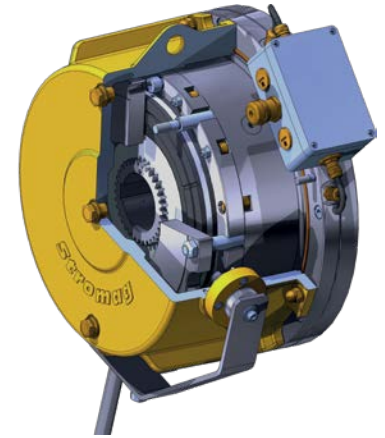

Benefits include

- Braking torque range 100 – 1600 Nm
- Degree of protection up to IP 67
- All components with special surface protection
- Operative without cover
- Simple assembly to motor, no dismantling of brake required
- Positive feel hand release mechanism
- Proven reliable design
- Sealed inspection holes for air gap or lining wear
- Extremely low inertia
- High heat dissipation
- Wide range of options like hand release lever, preparation for speedometer installation, terminal box, stand still heater, micro switches to monitor switching states and/or wear indication

POLE-FACE FRICTION BRAKE MFK/MWU-B

the active brake solution for all kind of industrial applications

Features:

The electromagnetic pole-face friction brakes are active brakes with a high ratio of torque to mounting space ensuring the transmission of torque free from backlash. They are particularly suitable for the active, nontwisting and energy efficient retention and positioning of drives.

Applications:

The MWU-B type with cap for IP 67 protection can be used offshore and under other difficult climatic conditions as in rolling mills, steel mills and mining.

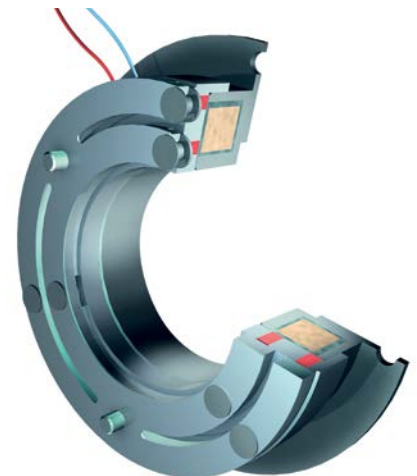

Benefits include

- Braking torque range 7 – 7800 Nm (higher on request)
- Operating-current brake with four pole technology for high power density
- With optional cap suitable for IP 67 protection (MWU-B type)
- High switching frequency
- Short switching times possible with optimized actuation
- Diaphragm technology for torque transmission free from backlash and disengagement free from residual torque
- Diaphragm connection for low axial restoring forces
- Steel-steel friction combination, hardened for high wear resistance

The Power Of One, The Strength Of Many.

OTHER PRODUCT SOLUTIONS FROM ALTRA INDUSTRIAL MOTION

WWW.ALTRAMOTION.COM

Our comprehensive product offerings include various types of clutches and brakes, overrunning clutches, engineered bearing assemblies, gearing and gear motors along with linear products, belted drives, couplings and limit switches. With thousands of product solutions available, Altra provides true single source convenience while meeting specific customer requirements. Many major OEMs and end users prefer Altra products as their No. 1 choice for performance and reliability.



ELECTRIC CLUTCHES AND BRAKES

Inertia Dynamics
Matrix
Stromag
Warner Electric



HEAVY DUTY CLUTCHES AND BRAKES

Industrial Clutch
Stromag
Svendborg Brakes
Twiflex
Wichita Clutch



OVERRUNNING CLUTCHES

Formsprag Clutch
Marland Clutch
Stieber



ENGINEERED COUPLINGS AND UNIVERSAL JOINTS

Ameridrives
Bibby Turboflex
Guardian Couplings
Huco
Lamiflex Couplings
Stromag
TB Wood's



GEAR DRIVES

Bauer Gear Motor
Boston Gear
Delroyd Worm Gear
Nuttall Gear



GEAR MOTORS

Bauer Gear Motor



POWER TRANSMISSION COMPONENTS

LINEAR ACTUATORS AND CONTROLS

Warner Linear



ENGINEERED BEARING ASSEMBLIES

Kilian



AIR MOTORS

Huco



BELTED DRIVES AND SHEAVES

TB Wood's



GEARED CAM LIMIT SWITCHES

Stromag

Stromag Facilities

Europe

Germany

Hansastraße 120
59425 Unna - Germany
+49 (0) 23 03 102 0

*Clutches & Brakes, Couplings,
Geared Cam Limit Switches, Discs,
Wind Brakes*

Dessauer Str. 10
06844 Dessau-Roßlau - Germany
+49 (0) 340 2190 0

Electromagnetic Clutches & Brakes

France

Avenue de l'Europe
18150 La Guerche sur L'Aubois - France
+33 (0)2 48 80 72 72

Disc Brakes & Drum Brakes

Great Britain

Amphill Road
Bedford, MK42 9RD - UK
+44 (0)1234 350311

*Electromagnetic Clutches & Brakes,
Industrial Caliper Brakes*

North America

USA

31 Industrial Park Road
New Hartford, CT 06057 - USA
860-238-4783

Electromagnetic Clutches & Brakes

300 Indiana Highway 212
Michigan City, IN 46360 - USA
219-874-5248

Couplings

2800 Fisher Rd.
Wichita Falls, TX
940-723-3400

*Geared Cam Limit Switches,
Industrial Caliper & Drum Brakes*

Asia Pacific

China

T40B -5, No. 1765 Chuan Qiao Road
Pudong 201206, Shanghai - China
Tel +86 21-60580600

*Clutches & Brakes, Electromagnetic
Clutches & Brakes, Couplings, Industrial
Caliper & Drum Brakes, Discs, Geared
Cam Limit Switches, Wind Brakes*

India

Gat No.: 44B/14, Shinde Vasti, Nighoje
Tal Khed, Pune- 410 501
+91 2135 622100

*Clutches & Brakes, Electromagnetic
Clutches & Brakes, Couplings, Industrial
Caliper & Drum Brakes, Discs, Geared
Cam Limit Switches, Wind Brakes*

The Brands of Altra Industrial Motion

Couplings

Ameridrives
www.ameridrives.com

Bibby Turboflex
www.bibbyturboflex.com

Guardian Couplings
www.guardiancouplings.com

Huco
www.huco.com

Lamiflex Couplings
www.lamiflexcouplings.com

Stromag
www.stromag.com

TB Wood's
www.tbwoods.com

Geared Cam Limit Switches

Stromag
www.stromag.com

Electric Clutches & Brakes

Inertia Dynamics
www.idicb.com

Matrix
www.matrix-international.com

Stromag
www.stromag.com

Warner Electric
www.warnerelectric.com

Linear Products

Warner Linear
www.warnerlinear.com

Engineered Bearing Assemblies

Kilian
www.kilianbearings.com

Heavy Duty Clutches & Brakes

Industrial Clutch
www.indclutch.com

Twiflex
www.twiflex.com

Stromag
www.stromag.com

Svendborg Brakes
www.svendborg-brakes.com

Wichita Clutch
www.wichitaclutch.com

Belted Drives

TB Wood's
www.tbwoods.com

Gearing

Bauer Gear Motor
www.bauergears.com

Boston Gear
www.bostongear.com

Delroyd Worm Gear
www.delroyd.com

Nuttall Gear
www.nuttallgear.com

Overrunning Clutches

Formsprag Clutch
www.formsprag.com

Marland Clutch
www.marland.com

Stieber
www.stieberclutch.com

Neither the accuracy nor completeness of the information contained in this publication is guaranteed by the company and may be subject to change in its sole discretion. The operating and performance characteristics of these products may vary depending on the application, installation, operating conditions and environmental factors. The company's terms and conditions of sale can be viewed at <http://www.altramotion.com/terms-and-conditions/sales-terms-and-conditions>. These terms and conditions apply to any person who may buy, acquire or use a product referred to herein, including any person who buys from a licensed distributor of these branded products.

©2018 by Stromag LLC. All rights reserved. All trademarks in this publication are the sole and exclusive property of Stromag LLC or one of its affiliated companies.



www.stromag.com

Hansastraße 120
59425 Unna - Germany
+49 2303 102-0