

## UL Testing

Before beginning any discussion of Warner Electric's program related to UL, it is important to clearly understand what lies behind the UL listing mark.

Underwriters' Laboratories Inc., (UL) is an independent testing organization. UL cooperates in the development of the (NEC) National Electrical Code published by the National Fire Protection Association, and with organizations such as (NEMA) National Electrical Manufacturers' Association and the (JIC) Joint Industry Conference in establishing standards. UL, however, is entirely independent. Contrary to what many people think, UL does not "approve" or "disapprove" electrical products. So, although the term "UL approved" is commonly used, it is incorrect. Instead, UL tests and evaluates a product according to applicable UL standards and then reports the results to the manufacturer. Because UL tests products for all foreseeable electrical hazards to life and property, safety conscious end-product users equate the UL symbol with product safety.

### Services

UL provides four testing services: certification, classification, listing, and recognition. Electrical products fit into one of these categories according to their intended use.

1. The "certification" service evaluates only field installed systems at specific locations, or specific quantities of certain products where it is impractical to apply the Listing Mark or Classification Marking.
2. The "classification" service evaluates products only for specific hazards or under specific conditions.
3. The "listing" service tests end-products for all reasonably foreseeable hazards to life and property. UL defines end-products as equipment for stand-alone use, or field installed.
4. The "recognition" service tests OEM components. UL defines components as devices that are factory installed in UL Listed, certified or classified end-product equipment.

The two services that apply to Warner Electric clutch/brake products are the last two: "Listing" and "Recognition." A product that is UL Listed has been successfully tested as an end-product for stand-alone use. A product that is UL Recognized has been successfully tested as a component.

The use of UL Recognized components simplifies the additional procedures required to achieve a higher UL category for end-use equipment. In general, all Warner Electric products with a conduit box and all packaged products are UL Listed. Other products, without a conduit box, are UL Recognized.

Products that are UL Listed are labeled with this symbol:



Products that are UL Recognized are labeled with this symbol:



### CSA

The authority for electrical standards in Canada is the Canadian Standards Association (CSA). CSA's tests and the procedure for submitting a product are similar to UL's; however, there is no reciprocal acceptance of products. Therefore, products must be sent to each organization for independent evaluation. Unlike UL in America, CSA is the only organization in Canada that can test electrical products. Also unlike UL, the same CSA mark may be used on both components and stand-alone equipment. However, components are certified only for use as part of an end-product. All Warner Electric industrial clutch/brake products are certified by CSA as components.



### UL and City Codes

Manufacturers of electrically powered equipment are not compelled legally to have their equipment UL tested. However, many municipalities and states refer to UL in their local codes. Los Angeles and Chicago, for example, maintain two of the strictest building codes in the country. Both make direct references to UL as the standard for electrical testing.



### Warner Electric and UL

When a product meets UL standards, it is entitled to carry a UL symbol. This symbol brings several benefits, perhaps the most important of which is improved product marketability. Because UL tests products for all reasonably foreseeable electrical hazards to life and property, safety conscious and users directly relate the UL symbol with product safety and reliability. Equally important, end product designers who use UL tested components save time and money in getting their end product listed.



## Allowable Cycle Rates

### Packaged and Basic Products, Sizes 120-1525

To determine maximum allowable cycle rate, select the chart which covers your size clutch or brake, refer to the horizontal "Load Inertia" axis and project vertically until intersecting the applicable RPM line. Then project horizontally to the left to intersect the vertical cycle/second axis. This is the maximum cycle rate allowable for class A operation, or 105°C maximum coil temperature.

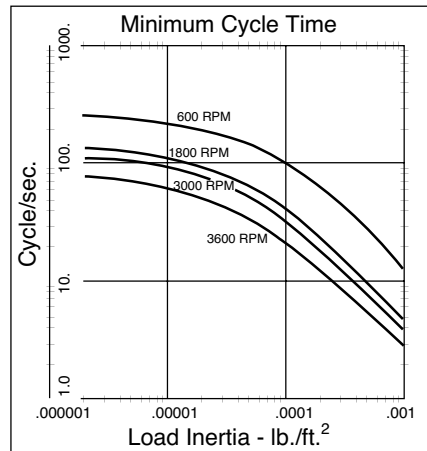

**Size 120**

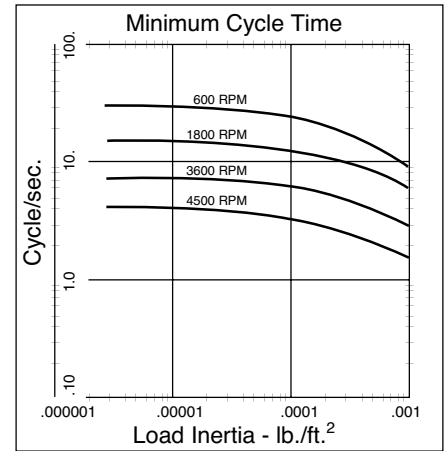

**Size 170**

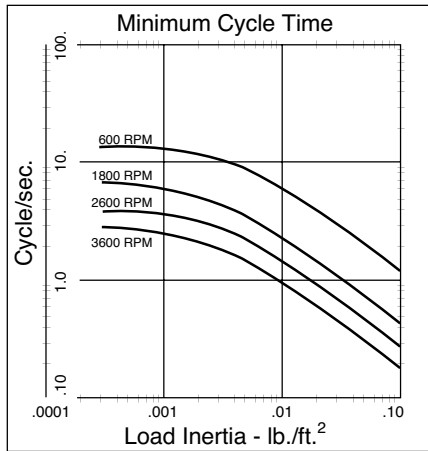

**Size 250**

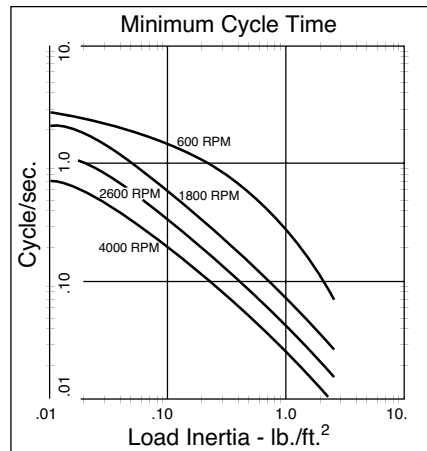

**Size 400 (EM 50)**

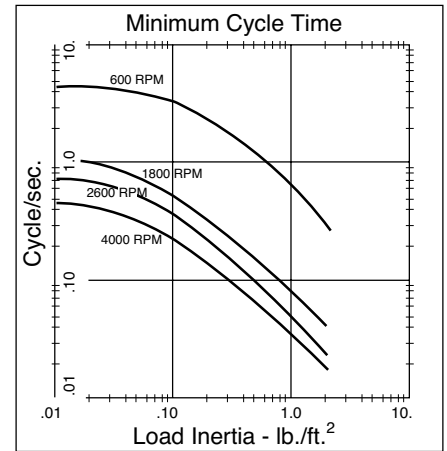

**Size 500 (EM180)**

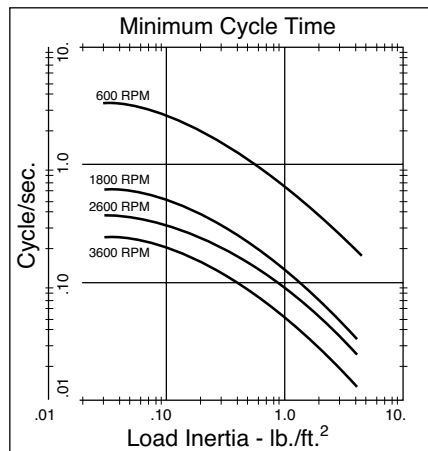

**Size 650 (EM 210 & 215)**

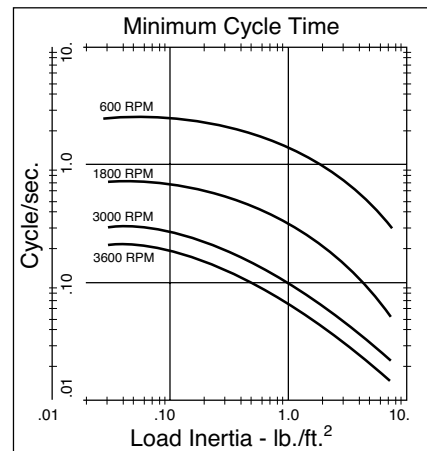

**Size 825**

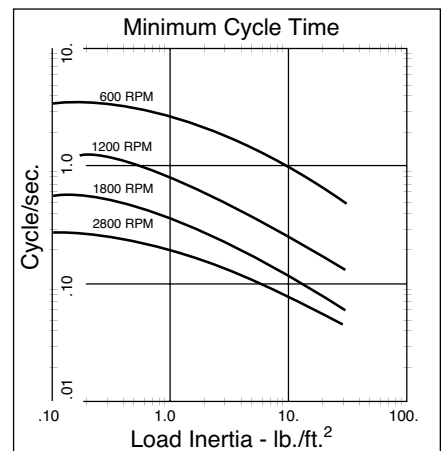

**Size 1000**

# Electrical Data Application Engineering

## Allowable Cycle Rates

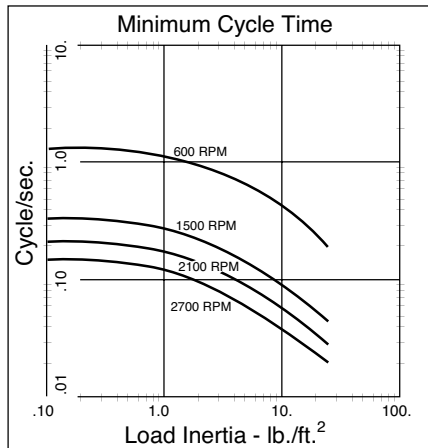

Size 1225

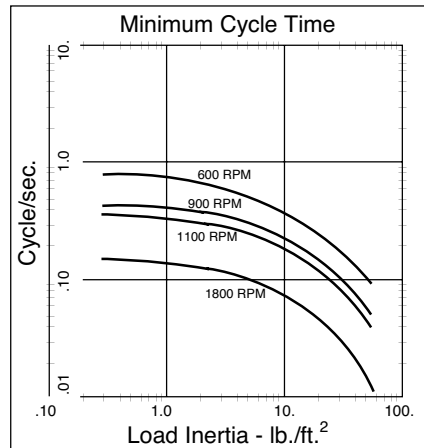

Size 1525

## Coil Ratings

Unit Size	SF/PB 120			SF/PB 170			SF/PB 250											
Voltage – DC	6	24	90	6	24	90	6	24	90									
Resistance @ 20°C – Ohms	6.32	104	1386	6.96	111.2	1506	5	76.4	1079									
Current – Amperes	.949	.230	.065	.861	.215	.060	1.2	.314	.084									
Watts	5.69	5.52	5.85	5.85	5.16	5.37	7.2	7.5	7.51									
Coil Build-up – milliseconds	12	12	11	17	17	16	48	48	44									
Coil Decay – milliseconds	8	8	7	8	7	6	15	15	13									
Unit Size	SF/PB 400			SF-500			PB & PC 500			SF-650								
Voltage – DC	6	24	90	6	24	90	6	24	90	6	24	90						
Resistance @ 20°C – Ohms	4.88	73	1087	1.076	14.9	206.1	1.36	23.8	251.1	1.16	17.7	225						
Current – Amperes	1.23	.322	.083	5.58	1.61	.44	4.4	1.01	.36	5.19	1.36	.4						
Watts	7.39	7.96	7.45	34	39	39	26	24	32	31	33	36						
Coil Build-up – milliseconds	154	154	154	82	85	90	84	87	93	110	115	120						
Coil Decay – milliseconds	62	60	55	40	40	40	38	35	30	50	50	50						
Unit Size	PB-650			SF-825			SF-825 Brg			PB & PC 825			SF-1000			PB & PC 1000		
Voltage – DC	6	24	90	6	24	90	6	24	90	6	24	90	6	24	90	6	24	90
Resistance @ 20°C – Ohms	1.24	18.3	257.2	1.23	20.9	267.0	1.098	14.6	221	1.27	20.4	223.3	1.07	14.4	214.4	1.23	19.7	248.7
Current – Amperes	4.84	1.31	.35	4.9	1.15	.34	5.464	1.65	.407	4.74	1.18	.4	5.61	1.67	.42	4.87	1.22	.36
Watts	29	31	32	29	28	30	33	40	37	28	28	36	34	40	38	29	29	33
Coil Build-up – milliseconds	100	105	110	222	200	245	180	200	225	170	170	170	256	275	283	205	220	235
Coil Decay – milliseconds	50	50	50	105	120	100	115	120	130	70	75	80	123	105	90	70	75	80
Unit Size	SF-1225			PB & PC 1225			SF-1525			PB & PC 1525			SF-1525 H.T.					
Voltage – DC	6	24	90	6	24	90	6	24	90	6	24	90	6	90				
Resistance @ 20°C – Ohms	1.21	19.5	268.3	1.33	22.3	261.7	1.11	15.5	239.1	1.45	19.8	258.4	55	113.4				
Current – Amperes	4.97	1.23	.34	4.5	1.08	.34	5.41	1.55	.38	4.13	1.21	.35	10.83	.794				
Watts	30	30	30	27	26	31	32	37	34	25	29	31	65	72				
Coil Build-up – milliseconds	475	490	510	300	320	350	505	535	575	470	490	512	480	560				
Coil Decay – milliseconds	240	230	220	190	190	190	230	237	215	200	170	140	210	160				

### NOTES:

Build-up time equals current to approximately 90% of steady state value and flux to 90%. Decay time equals current to approximately 10% of steady state value and flux to 10%. Approximately because current leads or lags flux by a small amount.

## Electrical Installation Procedures

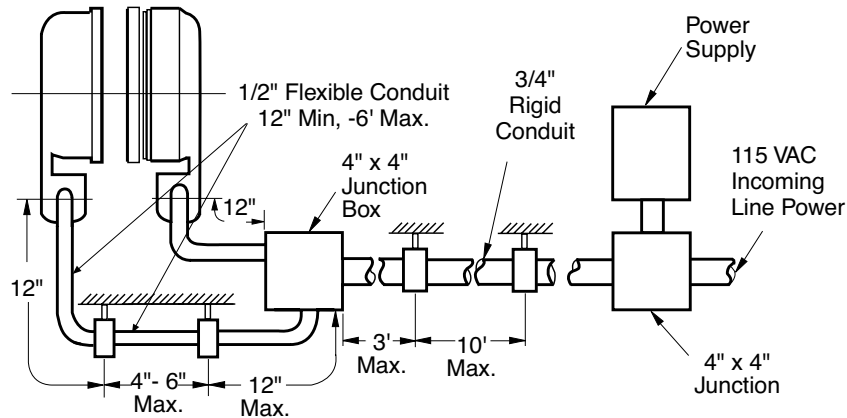

### Recommended Electrical Installation Procedure for Warner Electric Clutches and Brakes

Warner Electric clutches and brakes conform to UL (Underwriters Laboratories) and CSA (Canadian Standards Association) requirements. All packaged products come with conduit boxes or are enclosed in housings with provision for electrical conduit connection. All sizes 400 and larger SF clutch fields and brake magnets accept UL and CSA conforming conduit boxes available from Warner Electric.

The National Electrical Code (NEC) requires that conductors subject to physical damage be adequately protected. When electrical conduit is used, a minimum of 12" of 1/2" flexible conduit is to be used between each brake and/or clutch and its box. This construction will prevent improper bearing loading in bearing mounted units and ease field and magnet assembly and disassembly. Refer to the information below for proper

installation practices and wire sizes.

Notwithstanding the above recommendations, all electrical installations should conform to NEC and/or other governing electrical codes.

### Recommended wire size versus maximum distance

Wire Size AWG	Fractional Horsepower Sizes 170-400			Integral Horsepower Sizes 500-1525		
	Distance (feet)			Distance (feet)		
	6 Volt	24 Volt	90 Volt	6 Volt	24 Volt	90 Volt
18	20	280	1000	4	65	700
16	30	430		6	95	
14	50	720		10	160	
12	75	720		10	160	
10	125			25	400	
8	200			40		

General construction wire type MTW or THW recommended.  
 #6 terminal screws (size 400 and smaller) are to be torqued to 15 in.lb.  
 #8 terminal screws (size 500 and larger) are to be torqued to 20 in.lb.

## Coil Suppression and Clutch/Brake Overlap

Users of electric clutch and brake systems are sometimes concerned that a clutch and brake will oppose each other or “overlap” during switching, i.e., when the clutch is switched off and the brake is switched on, or vice versa. This concern relates primarily to dual armature type clutch/brakes similar to the Warner Electric Electro Module product line, as compared to shuttle armature clutch/brakes.

In use, Warner Electric clutches and brakes are not subject to overlap when Zener diode coil suppression techniques are applied to the clutch/brake control. All Warner Electric clutch/brake controls use Zener diode suppression to eliminate any overlap situations.

The charts below graphically display current decay of the clutch and current rise of the brake with Zener diode and with straight diode suppression. In Chart 1, which shows brake and clutch operation with Zener diode suppression, the “Overlap Area” below the intersection of the brake and clutch current lines shows potential for the devices to fight one another. But this intersection occurs at an extremely low current level and the armature Autogap® springs keep the friction surfaces of the

brake armature and magnet separate at such low currents. Even though there is the appearance of a minor clutch/brake overlap in this instance, the brake armature has not yet contacted the brake magnet. Chart 2 shows a much larger overlap area since straight diode suppression is used in this circuit. Clutch current has not decayed fully as the brake is engaged and the load is brought to zero speed.

Clutch and brake coils are inductors. Inductance is the electrical equivalent to mechanical inertia and an energized coil dissipates its energy when turned “off.” Upon removal of power, voltage across an inductor reverses and current continues to flow in the same direction until the energy is fully dissipated. Without suppression in the control circuit, an arc can result from this potentially very large reverse voltage which can damage the electrical switching contacts.

Consequently, Zener diode suppression circuitry, by limiting the reverse voltage to a sufficiently high but safe level, has two major benefits:

- Hastens coil decay
- Protects the switching contacts

The schematics below show circuits with no suppression and both straight diode and Zener diode suppression.

The rapid coil decay of Zener diode suppression lets users enjoy the major advantages which dual armatures have over single, “shuttle” armatures. These include:

- Better heat dissipation – greater area to give off heat and more “off” time.
- Longer life – two armatures absorb wear.
- Armature Autogap® self adjusting for the life of the unit
- Enhanced repeatability and controllability with the use of a light preload spring to keep the armatures in light contact with their mating surfaces, eliminating armature movement time and reducing noise and spline wear. Warner Electric utilizes this preload spring in some packaged clutch/brake models including ceramic EPs and Unimodules and Smooth Start Unimodules.

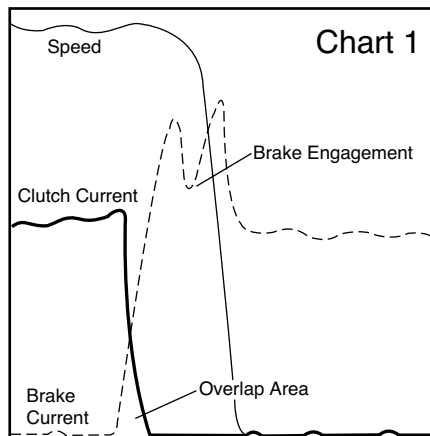

### Brake Engagement with Zener Diode Suppression

Clutch current decay and brake current rise overlap, but the brake armature is not engaged until well past the overlap point. Note that the “blip” in the brake current trace coincides with the sharp decline in the “speed” trace, indicating brake armature engagement at that point.

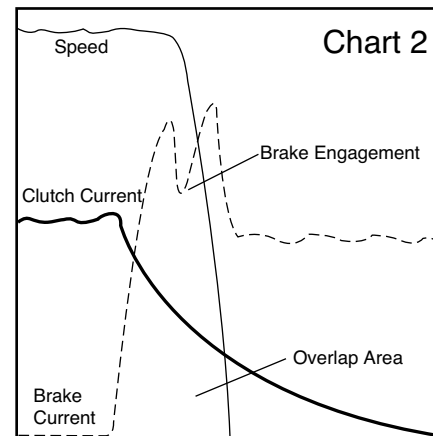

### Brake Engagement with Straight Diode Suppression

Clutch current decay is much slower than with Zener diode suppression as shown in Chart 1, greatly increasing the overlap area. The current level in the clutch coil is much higher at the point of brake engagement than with Zener diode suppression.

VAC = AC power source  
SW = Clutch selector switch  
CL = Clutch  
CNTL = Control module

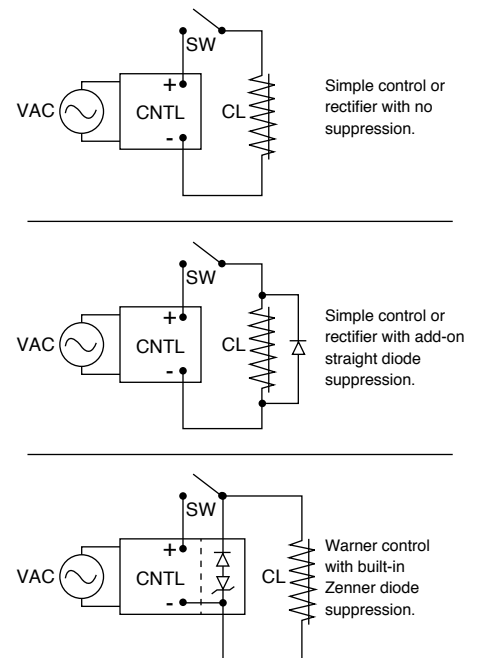

## Overexcitation

Overexcitation is a technique which makes a clutch or brake engage faster and have greatly improved starting and stopping accuracy. It involves applying over voltage to the clutch or brake coil to reduce current build up time, thereby reducing the magnetizing time.

The graphs below show current rise and shaft speed for an identical system using a Warner Electric EP-400 clutch/brake both with and without overexcitation. The effect of overexcitation is to reduce the time needed to achieve full current and thereby reduce the time required to achieve full speed with a clutch or zero speed with a brake. In the example below, "time to start" is approximately 70 ms without overexcitation. This is

reduced to 30 ms when overexcitation is applied. This time is comparable to the coil buildup times stated on page 248. The "time to stop" has been similarly reduced; the nominally excited system requires about 110 ms to stop the load, while this is accomplished in only 50 ms with overexcitation.

Overexcitation does not increase torque. Rather, the reduction in start-stop times comes from reduced coil current build up times (or "time to current"). For many common industrial applications, the reduction in "time to speed" and "time to stop" is one half when using overexcitation.

The use of overexcitation on a clutch/brake system does not increase system wear. In fact, the clutch/brake wear rate may be reduced because slippage and energy dissipation is marginally reduced in the clutch/brake. Compliance in the drivetrain may absorb some of the start/stop inertia or wear may be observed in other drivetrain components. Whenever overexcitation is used, adequate coil suppression must be employed. Please refer to "Coil Suppression and Clutch/Brake Overlap" on page 250.

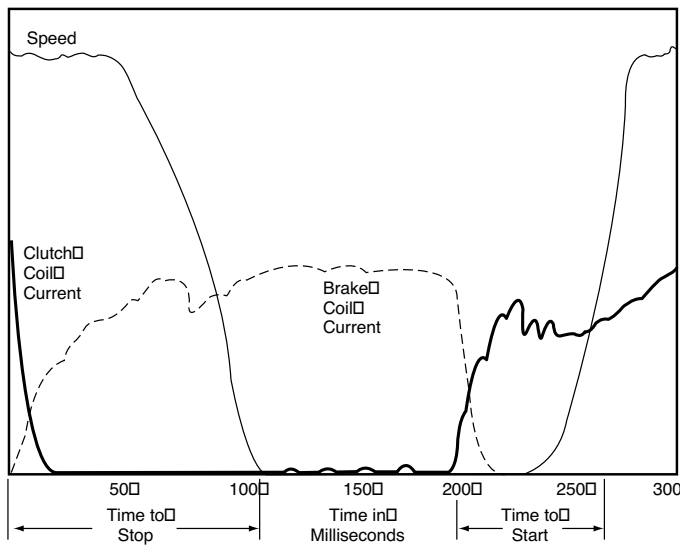

**Chart 1**  
**Without Overexcitation**

Current/speed trace of EP400 clutch/brake being run through a single stop/start cycle. Note that 110 milliseconds is required to stop from the time the clutch coil is de-energized and the brake coil is energized. At the 200 milliseconds point on the graph the clutch coil is energized and the load is at speed 70 milliseconds later. Note that the coil current is still increasing after the load is at full speed.

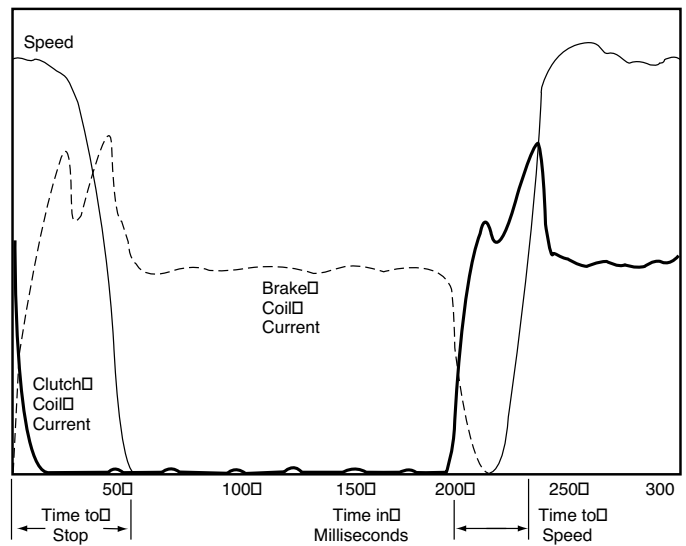

**Chart 2**  
**With Overexcitation**

Current/speed trace of EP400 clutch/brake being run through a single stop/start cycle. With overexcitation, both brake and clutch coil currents build much faster with concurrent reductions in both stop and start times, when compared with Chart 1.