

# Mechanical Data Dynamic Torque

## NOTES:

Speed difference means the difference in speed between one friction face and the other at the moment of engagement. The intersection of the top curve and the speed difference is the maximum torque produced by the unit. When both friction faces are engaged and rotating at the same speed, the unit is said to be locked-in and produces the maximum static torque (zero speed difference).

The % lines indicate the percentage of full voltage being used. Example: If 90 volt unit runs at 45 volts, use the 50% line.

Average Torque = Dynamic Torque at  $1/2$  operating speed. Example: If operating speed is 1800, use dynamic torque at 900.

**Size 120** Maximum Speed 10,000 rpm  
Static Torque 5 lb./in.

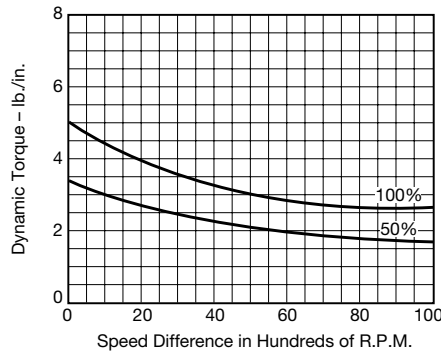

**Size 170** Maximum Speed 10,000 rpm  
Static Torque 15 lb./in.

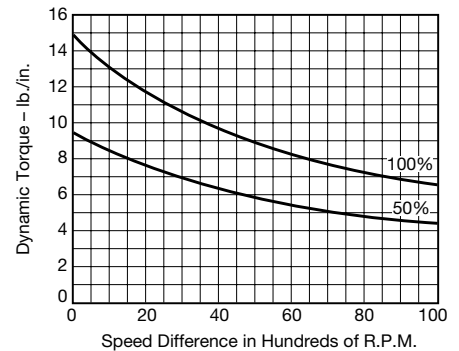

**Size 250** Maximum Speed 7,500 rpm  
Static Torque 70 lb./in.

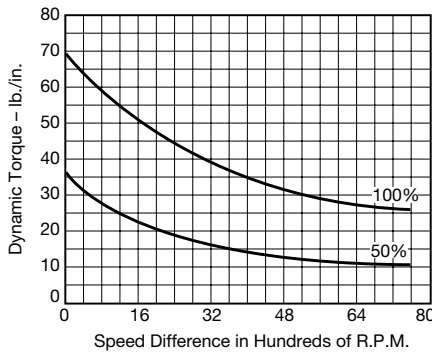

**Size 400** Maximum Speed 4,500 rpm  
Static Torque 270 lb./in.

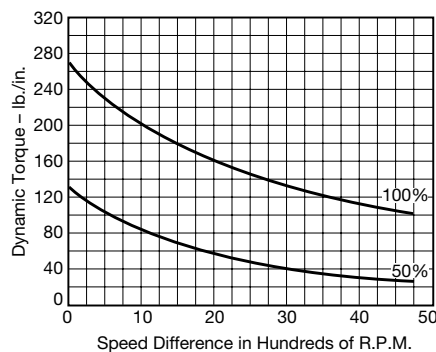

**Size 500-SF** Maximum Speed 4,000 rpm  
Static Torque 50 lb./ft.

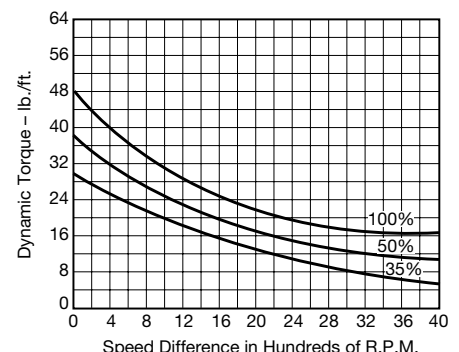

**Size 500-SF** Maximum Speed 4,000 rpm  
Static Torque 50 lb./ft.

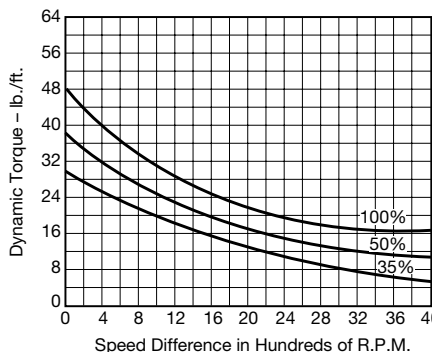

**Size 650** Maximum Speed 3,600 rpm  
Static Torque 95 lb./ft.

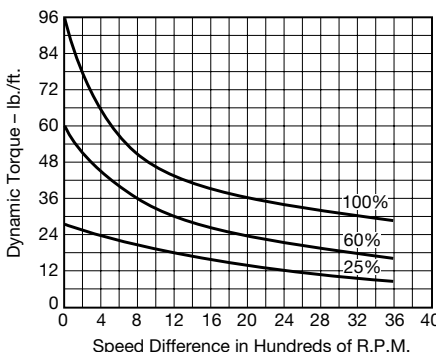

**Size 825-SF** Maximum Speed 3,600 rpm  
Brg. Mtd. Static Torque 150 lb./ft.

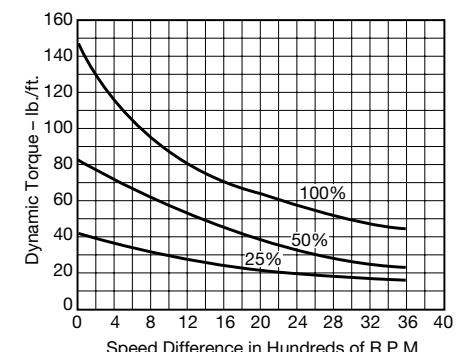

NOTE: Torque values are in inch lbs. for size 400 and smaller, and in ft.lbs. for size 500 and larger.

# Mechanical Data Dynamic Torque

**Size 825** Maximum Speed 4,000 rpm  
Electro-Pack 3,600 rpm  
Static Torque 125 lb./ft.

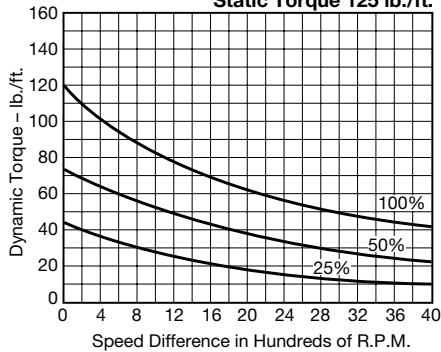

**Size 825-MB** Maximum Speed 4,000 rpm  
Static Torque 80 lb./ft.

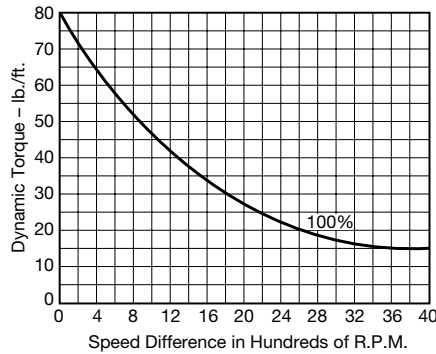

**Size 1000** Maximum Speed 3,600 rpm  
Electro-Pack 3,000 rpm  
Static Torque 240 lb./ft.

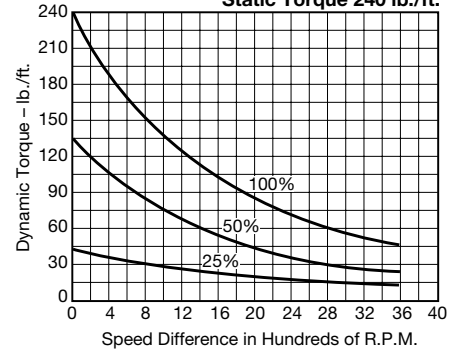

**Size 1000-MB** Maximum Speed 3,600 rpm  
Static Torque 160 lb./ft.

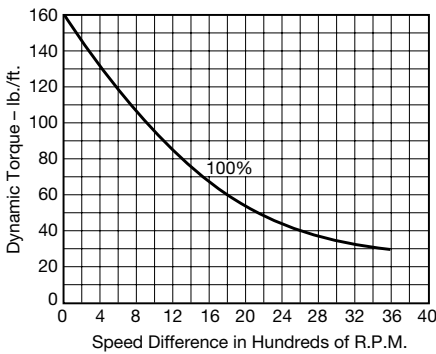

**Size 1225** Maximum Speed 3,000 rpm  
Static Torque 465 lb./ft.

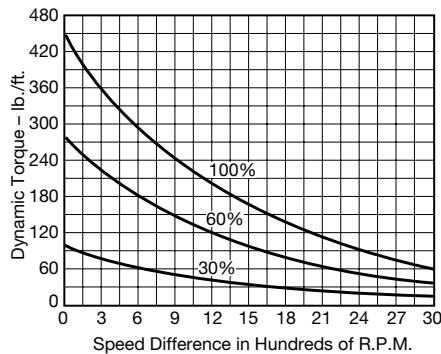

**Size 1225-MB** Maximum Speed 3,000 rpm  
Static Torque 260 lb./ft.

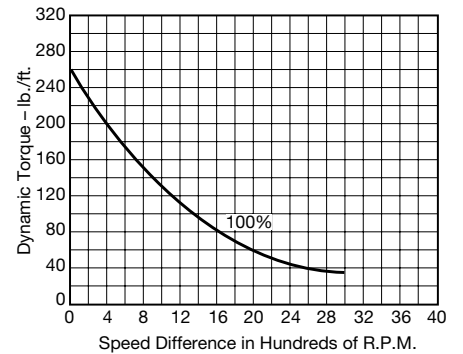

**Size 1525** Maximum Speed 2,000 rpm  
Electro-Pack 1,800 rpm  
Static Torque 700 lb./ft.

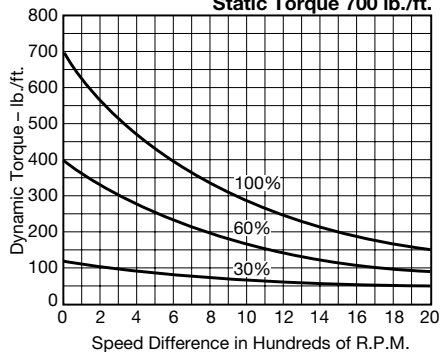

**Size 1525-Hi Torque** Maximum Speed 2,000 rpm  
Static Torque 1,350 lb./ft.

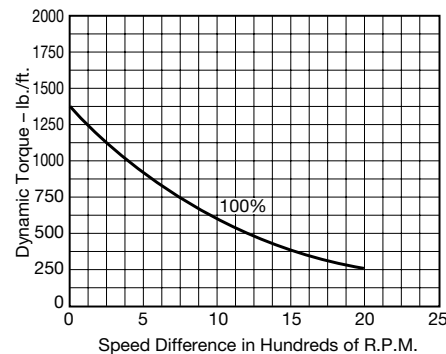

## Rotational Speed

Rotational speed of a clutch or brake is an important consideration when selecting a unit for a particular application. Numerous factors must be considered, such as the maximum rated speed of the clutch/brake unit, the dynamic torque required, the heat dissipation needed, the effect of speed on wear rate, and torque stability at very low speeds. Each of these issues are separate, and sometimes interrelated, but always important in selecting the right product for an application.

## Maximum RPM Rating

The most important rotational speed consideration is the maximum rated RPM capability of a unit. DO NOT exceed this rating. Exceeding the maximum RPM of a unit may cause personal injury and/or machine damage. Maximum rated speeds are based on the structural integrity of the rotating components and associated shaft and bearing capabilities. If the RPM rating is exceeded, structural failure may occur, or the unit may experience premature bearing failure and/or premature friction material wear out.

## Dynamic Torque

When determining the correct size clutch/brake for an application, dynamic torque at the highest slip speed is often the determining factor. As you can see by reviewing the dynamic torque curves for different units as shown starting on page G-4, dynamic clutch/brake torque usually decreases with higher speeds. As slip RPM increases, the coefficient of friction of a unit decreases, causing a decrease in dynamic torque availability. Be careful to consider this when selecting the appropriate unit size needed.

## Heat Dissipation

Heat dissipation is inversely related to dynamic torque. As RPM increases, the heat dissipation ability of a unit increases. When an armature is rotating, the heat dissipation rate is proportional to the aerodynamic fan effect of the rotating armature. The faster the armature rotates, the greater the heat dissipation. This is illustrated with a typical catalog curve as shown in Figure 1. It's interesting to note that, at zero RPM, the unit still has some heat dissipation capability. This is due to convection and radiation, but is usually not an important consideration.

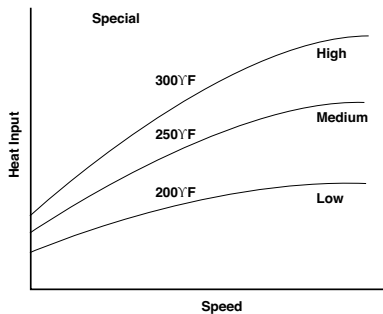

**Figure 1:** Typical Heat Dissipation Characteristics

## Wear Rate

The wear rate of friction surfaces is dependent on the clamping pressure of the mating surfaces as well as the surface velocity between the wearing surfaces. Many variables are involved in predicting wear life, of which RPM is probably the most influential. Typically, the wear rate will increase directly with the rubbing velocity distance. Another way of stating this is the higher the relative engagement speeds of two rotating parts, the longer they are allowed to slip against each other and the faster the wear rate.

## Low Speed Operation

The effect of low speed usage should also be considered in applications. Performance of clutch/brake units at less than 100 RPM may be very different than at higher RPM. This is due to “burnish” characteristics of friction surfaces.

## Wear In

“Burnish” is the wear in, or mating of two surfaces. When new, these surfaces have manufacturing features which include roughness and waviness. When these surfaces come into initial contact, only the high spots actually meet. See Figure 2. This results in only a small surface area in contact, while the non-contact surface area is “air.” The result is low torque. As the mating surfaces continue to engage and slip against each other, the high spots are worn down and more surface area is in contact, thus increasing torque capability. This wear in period, or burnish, typically occurs in the first few hundred cycles of a clutch/brake’s life. Faster slip speeds and higher loads mean fewer cycles needed to complete the burnish process. For applications where the speed is less than 100 RPM, the required application torque

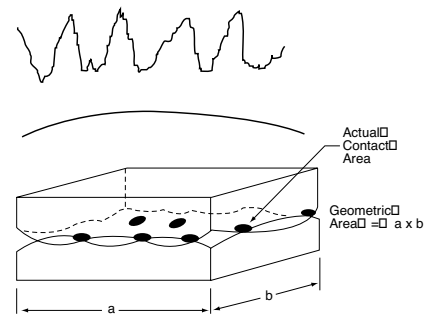

**Figure 2:** Unburnished Contact Areas

should be doubled to compensate for the low speed “burnish” that the unit experiences. A low speed burnish will require many cycles before full torque and stability are achieved. For example, if an application is determined to need 20 ft.lbs. of static torque, an SF-400 clutch could be selected. But, if the application is only 100 RPM or less, then an SF-500 unit should be the choice to compensate for the low RPM usage, as indicated on the selection chart found on page G-4.

Careful consideration of rotating speeds will help the selection process of an application. Follow these guidelines and the proper clutch/brake selected will provide troublefree operation.

# Mechanical Data Clutch Field Restraining Devices

Many Warner Electric clutch assemblies have a bearing mounted stationary field. By design the bearing maintains its proper position between the field and rotor making it easy for the customer to mount the field-rotor assembly. However, the bearing has a slight drag which tends to make the field rotate if not restrained. And, since the field has lead wires attached, it must be restrained to prevent rotation and pulling of these wires. To counteract this rotational force, the field has a "torque tab" to which the customer must attach an appropriate anti-rotational restraint.

A few hints regarding proper torque tab restraints are in order. First and foremost, it is important to recognize that the force to be overcome is very small and the tab should not be restrained in any manner which will preload the bearing. For example, if the clutch is mounted with the back of the field adjacent to a rigid machine member the customer should not attach a capscrew tightly between the tab and the machine member. This may pull the tab back against the rigid member as shown in Figure 1 and preload the bearing. The recommended methods are illustrated in Figures 2, 3, and 4. The method selected is primarily a matter of customer preference or convenience.

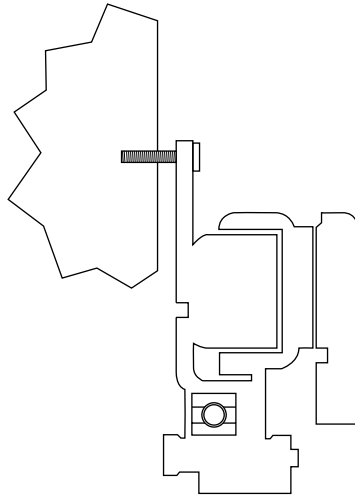

**Figure 1:**  
Rigid member

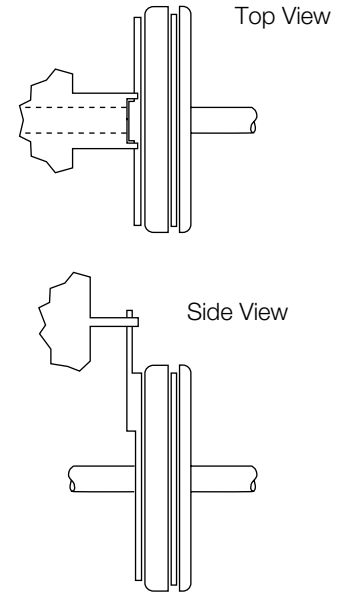

**Figure 2:**  
Rigid Member with Slot  
Straddling Tab  
(Preferred)

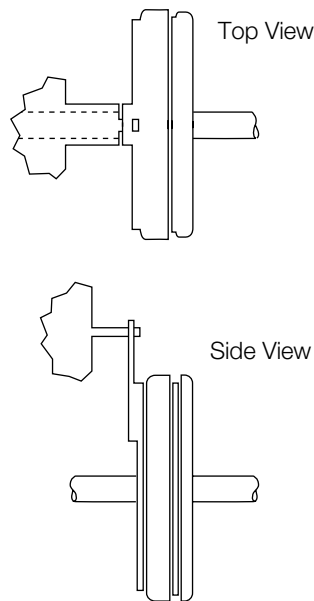

**Figure 3:**  
Pin in Hole  
Loosely  
(Preferred)

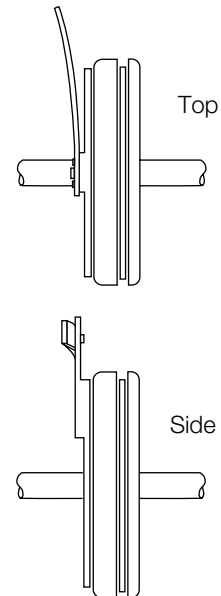

**Figure 4:**  
Flexible Strap  
(Preferred)