

I N T R O D U C I N G

WR225 VAR22

Spring Applied Electrical & Manual
Released Brakes

Highly reliable, built-in-flexible design for static engagement with some emergency stop capability

Units are highly reliable, spring applied devices designed as statically engaged/disengaged holding brakes. Compact **WR225** VAR22 brakes are specifically designed for static engagement with some emergency stop capability and are available with manual release and optional limit switch.

Warner Electric approaches every application from the standpoint of finding the best functional solution, built-in-flexible design allows **WR225** VAR22 brakes to be customised to fit many applications.

Typical Applications

- Scooters/Wheelchairs
- Patient hoists
- Handheld power tools
- Conveyors
- Machine tools
- Robotics
- Floor sweepers/cleaners

Features

- Extremely compact design
- Intended for use in static applications
- 2 Nm torque to 4 Nm torque
- Maximum hub bore 10 mm
- 57 mm shell diameter
- Manual release left or right, optional switch
- Optional plastic lever cover
- RoHS compliance



Industrie Service

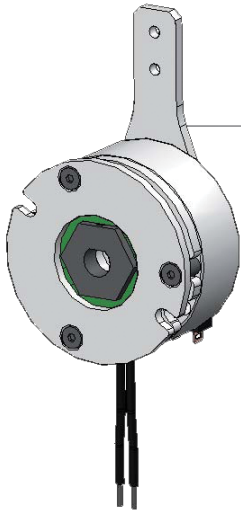

WR225 VAR2

Spring Applied Electrical & Manual Released Brakes

Flange Mount with Rotary Release Mechanism

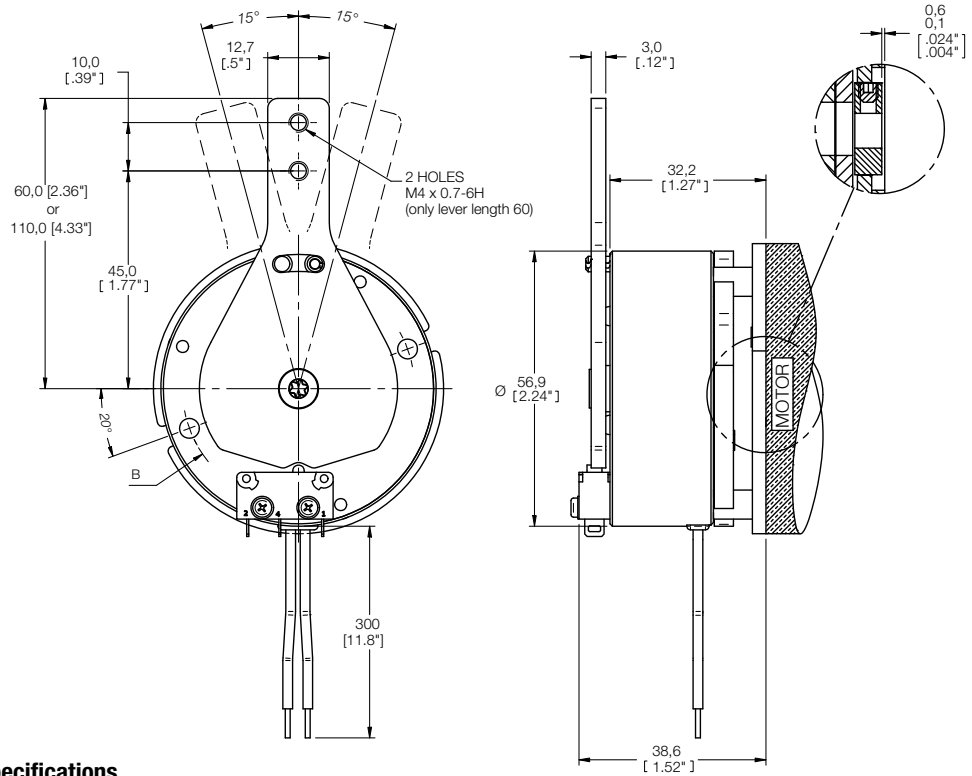

Specifications





(Other non-standard voltage, power, lead length or color available upon request and subject to extra charge)

Static Torque	Temperature	Duty Cycle	Voltage	Power
2 Nm 3 Nm 4 Nm	Ambient -20 / +40° C	50% max	12 VDC 24 VDC	11 Watt

Options (Other lengths, diameters or shapes available upon request and subject to tooling charge)

Flange Mount			Release Mechanism
End plate outer Ø A	Mounting PCD Ø B	No. holes	
*57 mm [2.24"]	*48 mm [1.89"]	2	CW or CCW (Not bi directional)
70 mm [2.76"]	62 mm [2.44"]	2	
75 mm [2.95"]	68 mm [2.68"]	2, 3 or 4	
80 mm [3.15"]	72 mm [2.84"]	2, 3 or 4	

*Only available on torque range 3 Nm max.

Hexagonal Hub drive		Hexagonal Plastic Friction disc	Hexagonal Fiber Friction disc
Ø Options plain	Ø Options D drive		
 6,0 mm 6,35 mm (0.25") 8,0 mm 9,5 mm (3/8") 10,0 mm	 8,0 mm 10,0 mm		

N.B.: Options to be selected with Warner Electric Sales Engineers
Maximum motor shaft length = 9,9 mm [0.39"]

Subject to alteration without prior notice