

AC Rectifier CBCx-001

Installation & Operation Manual

P-2100-WE
CBCx-001





An **Altra Industrial Motion** Company

Function

The CBCx-001 power supply is an AC rectifier providing a time programmable Over-excitation voltage as well as an integrated On/Off switch. This is particularly suitable to all Power-Off applications based on our well known Elevator Brakes, ERD or ERS brakes.

The Over-excitation feature is automatically switching from a Full bridge to a single wave rectification after a programmable time (from 50 ms up to 4 s). It can easily be disabled to convert your power supply in a Single or Double wave rectifier. The On/Off Control allows this power supply to be driven directly thru an external PLC or Control board. Thanks to its integrated PNP input, the power can be directly applied or removed without using any external Switches or Relays. The DC power-off feature associated to the state of the art snubber design allows drastic reduction of the engagement time requested by most of the security related applications.

Ratings

Input Voltage	100 VAC to 500 VAC (+/- 10%) 50 – 60 Hz
Output Voltage	90 VDC to 450 VDC
Maximum Output Current	5 Amps max (See below conditions)
Over-Excitation	Integrated programmable timer (from 50 ms to 4 s)
ON/OFF Control	Integrated PNP Input (8 to 30 VDC). (can be disabled)
Shorter Response time DC switch off	Integrated back EMF suppression
Certifications	CE, UL approved
Operating T°C	-25°C to 70°C no Condensation (Check below instructions for more details)
Compliance	  

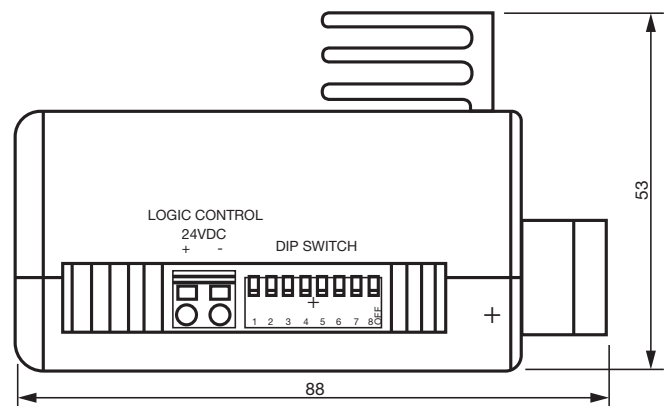
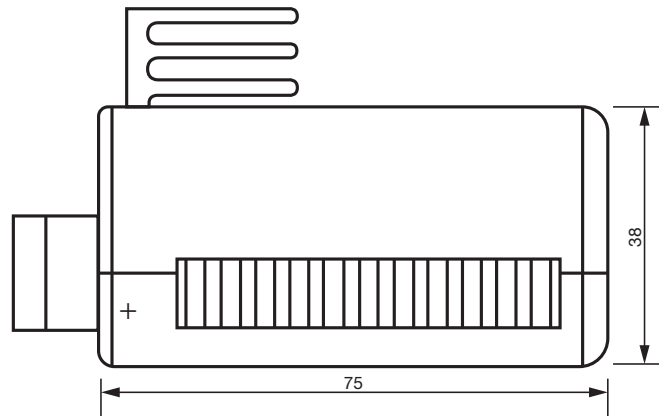
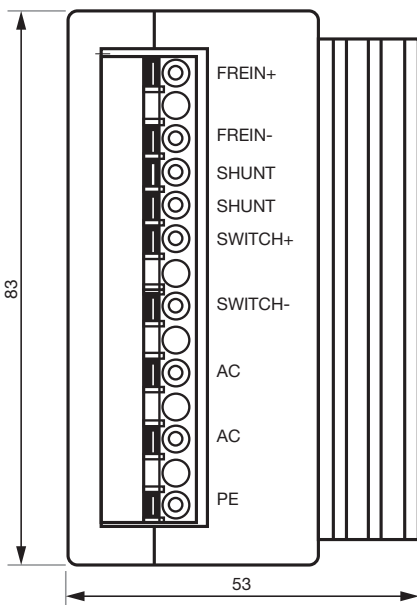

General information

Power supply enclosure should be kept clear of all areas where foreign material, dust, grease, or all might affect the operation of the control.

Installation must be made in accordance with the instructions found in this manual. Failure to do so may damage the Power supply.

Electrical Connection

1	DC BRAKE +	Power Output	Output contact to the Clutch/Brake Coil. DC Power output : 90 VDC to 450 VDC.
2	DC BRAKE -	Power Output	Output contact to the Clutch/Brake Coil.
3	SHUNT+	Accessory	Current Sensing. Contact which allows the opening of the power supply DC Side to integrate a current sensing or over measuring instrument. One can add a Hall effect current probe for instance. Default : When not used, a Short circuit bridge is needed between pins 3 and 4.
4	SHUNT-	Accessory	Current Sensing.
5	DC SWITCH +	Accessory	DC switching off. Use to Power off the brake with a Fast Response Time : Emergency stop for instance. Default : When not used, a Short circuit bridge is needed between pins 5 and 6.
6	DC SWITCH -	Accessory	DC switching off.
7	AC	Power Input	AC power Input : 90VAC to 500VAC
8	AC	Power Input	AC power Input : 90VAC to 500VAC
9	PE	Protective Earth	This terminal is usually connected to earth provided by the AC grid.

Logical Control 1	ON/OFF +	Digital input	Logic Control. 24V PNP input. When High, powers up the brake. This power up will be made on the AC side, with offering If over-excitation feature is enabled, then over-excitation voltage is applied during the programmed time. Active High/GND: PNP type Input.
Logical Control 2	Ground	Digital input	Ground

Synoptic:

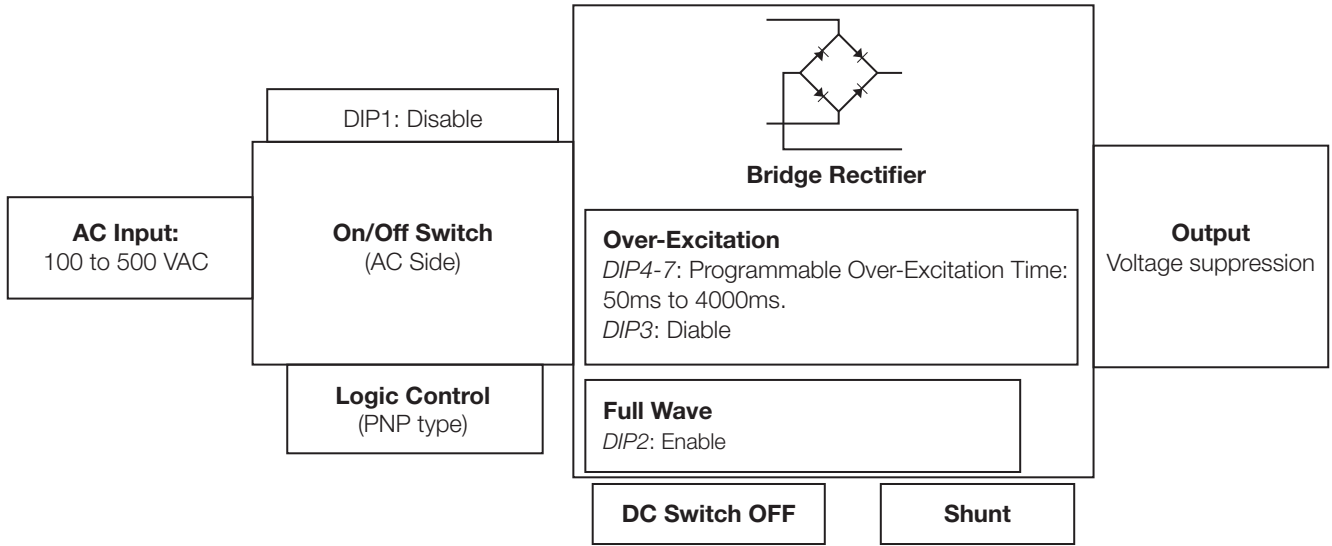

Technical Data

Input Voltage		100 VAC to 500 VAC (+/- 10%) 50 – 60 Hz
Output Voltage		90 VDC to 450 VDC
	With Over-excitation	$U_{Brake} (VDC) = 0,9 \times U_{AC}$ (Limited to the selected over-excitation time)
	Full Wave	$U_{Brake} (VDC) = 0,9 \times U_{AC}$
	Half Wave (Holding voltage)	$U_{Brake} (VDC) = 0,45 \times U_{AC}$
	Max T °C	
Output Current	70°C	2 Amps Over-excitation (double Wave) / 1 Amps Holding (Single Wave)
	60°C	3 Amps Over-excitation (double Wave) / 1.5 Amps Holding (Single Wave)
	50°C	5 Amps Over-excitation (double Wave) / 2.5 Amps Holding (Single Wave)

DIP Switch selection

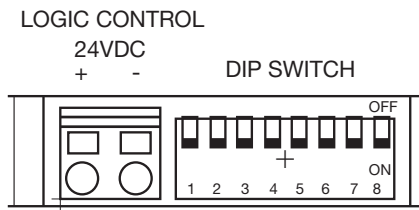

DIP1	if ON	PNP Logic control input disabled								
DIP2	if ON	Full Wave forcing If ON, Over-excitation is always enabled.								
DIP3	if ON	Over-excitation Disabled								
		50ms	100ms	150ms	500ms	1000ms (Default)	1500ms	2000ms	3000ms	4000ms
DIP4	ON	ON	ON	ON	ON	ON	ON	ON		
DIP5	ON	ON		ON	ON				ON	
DIP6	ON		ON	ON		ON				
DIP7				ON	ON	ON	ON	ON	ON	ON
DIP8	Not used									

Examples

AC switching with external contactor (not supplied) / 24VDC PNP Control not used / 1s Over-excitation:

DIP1:	ON	DIP2:	OFF	DIP3:	OFF	DIP4:	ON	DIP5:	ON	DIP6:	OFF	DIP7:	ON
--------------	----	--------------	-----	--------------	-----	--------------	----	--------------	----	--------------	-----	--------------	----

24VDC PNP Control Enabled / 500ms Over-excitation:

DIP1:	OFF	DIP2:	OFF	DIP3:	OFF	DIP4:	ON	DIP5:	ON	DIP6:	ON	DIP7:	ON
--------------	-----	--------------	-----	--------------	-----	--------------	----	--------------	----	--------------	----	--------------	----

AC switching with external contactor (not supplied) / 24VDC PNP Control not used / Full wave control (no Over-excitation):

DIP1:	ON	DIP2:	ON	DIP3:	NA	DIP4:	NA	DIP5:	NA	DIP6:	NA	DIP7:	NA
--------------	----	--------------	----	--------------	----	--------------	----	--------------	----	--------------	----	--------------	----

AC switching with external contactor (not supplied) / 24VDC PNP Control not used / Half wave control :

DIP1:	ON	DIP2:	OFF	DIP3:	ON	DIP4:	NA	DIP5:	NA	DIP6:	NA	DIP7:	NA
--------------	----	--------------	-----	--------------	----	--------------	----	--------------	----	--------------	----	--------------	----

Installation

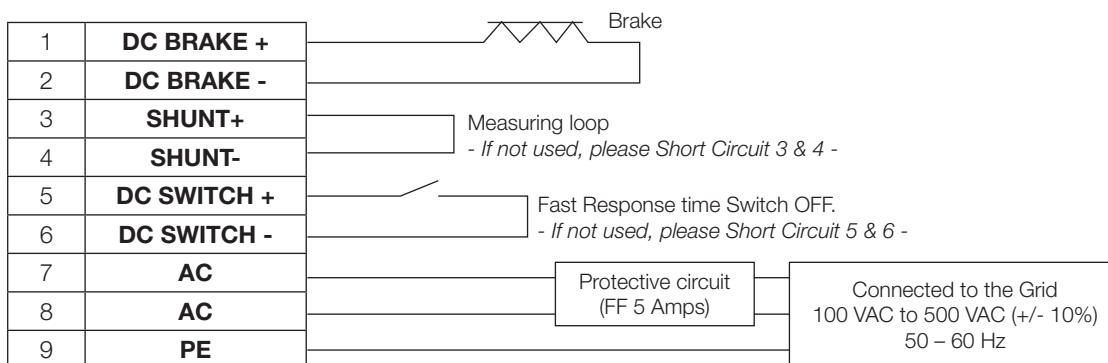



www.warnerelectric.com

7, rue Champfleu, B.P. 20095
St Barthelemy d'Anjou - France
+33 (0)2 41 21 24 24
Fax: +33 (0)2 41 21 24 70

An **Altra Industrial Motion** Company

