

CBC-1500AHFC & 1550AHFC Closed Loop Unidirectional Clutch/Brake Control System

P-291
819-9050

Installation Instructions



⚠ WARNING To prevent personal injury, ensure all personnel are clear of conveyor line and the pusher before performing any adjustments on the control.



An Altra Industrial Motion Company

Contents

Introduction	2	Additional Features.	13
Ordering Information	3	CBC-1000AH Diagnostic Tests	14
Specifications	3	Troubleshooting	15
Installation	3	Electrical Diagram	16
Connection Diagram CBC-1500	4	Dimensional Diagram	17-18
Control Adjustments.	4	Programming Adjustments	19-20
Connection Diagram CBC-1550	5	Terminology	21
CBC-1000AH Operation.	6	Torque Adjustments	21
Programming	7	Warranty	Back Cover

⚠ WARNING Failure to follow these instructions may result in product damage, equipment damage, and fatal injury to personnel.

Introduction

Warner Electric's CBC-1500AHFC and CBC-1550AHFC are closed-loop positioning controls designed with error compensation and auto-home capabilities for industrial clutch/brake applications. The position loop is closed through encoder feedback which generates pulses proportional to load motion. The CBC-1500AHFC and CBC-1550AHFC use this feedback to determine the optimum brake actuation point. The autohome feature requires a marker input from the encoder to find its user defined home position upon power up. The CBC-1500AHFC and CBC-1550AHFC are a combination of a CBC-

1000AH and a CBC-500 or CBC-550, respectively, joined together in one package for a total control solution (for more information on either control refer to the Warner Electric Master Catalog, P-1000). Dual channel torque adjustment is provided via on-board potentiometers for accomplishing soft starts and stops. Each unit operates in absolute mode where it maintains its position in an absolute sense and compensates for any slight errors made on the prior move. The two outputs can be energized alternately or simultaneously and internal circuitry provides suppression of transients during decay of the magnetic field to assure rapid cycle rates.

Installation

⚠ WARNING The voltage present in this control can cause serious injury (even death). When installing the control or any electrical equipment, make certain that the input power is off. Do not apply power to this control until it is securely mounted and completely wired in accordance with local codes and all installation work, including cleanup, has been completed.

Ordering Information

Model Number	Part Number
CBC-1550AHFC Control	6050-448-008
CBC-1500AHFC Control	6050-448-006
Encoder Cable (Accessory)	6060-101-003
600 Pulse Per Revolution Encoder with Marker Pulse & 10' Cable	6060-101-061
RS-232 to RS-422/485 Converter (Accessory)	6060-101-232

Specifications

Input:

- CBC-1500AHFC-90: 120 VAC \pm 10%, 50/60 Hz, 1 Phase, 300 VA max.
- CBC-1000AH: Switch selectable AC power input to be 120 VAC only.
- CBC-1550AHFC-24: 220 VAC \pm 10%, 50/60 Hz, 1 Phase, 300 VA max.
- CBC-1000AH: Switch selectable AC power input to be 220 VAC only.

Programming Options (described on pages 6 through 8.)

Start input:

- CBC-1500AHFC: 120 VAC
- CBC-1550AHFC: 24 VAC

Output:

- CBC-500-90: 0-90 VDC full-wave rectified nominal, 1.0 amp per channel max., 2.0 amps total.
- CBC-550-24: 0-24 VDC full-wave rectified nominal, 4.0 amps per channel max, 4.0 amps total.
- CBC-1000AH: Open collector active low outputs, 100mA sink max., 24 VDC max.

Circuit Protection: (fusing)

- CBC-1500AHFC-90: 1.6 amps, 250 V fast blo
- CBC-1550AHFC-24: 3 amps, 250 V fast blo
- CBC-500-90: 2.5 amps, 250 V fast blo, 3AG
- CBC-550-24: 5 amps, 250 V fast blo, 3AG

Encoder:

600 ppr with marker pulse.

Adjustments:

- CBC-500-90 and CBC-500-24:
 - Channel 1 Voltage (via potentiometer)
 - Channel 2 Voltage (via potentiometer)
 - Jumper (selects simultaneous or alternate mode)
 - Frequency Adjustment: 60-400 Hz (via potentiometer)
- CBC-1500AHFC and CBC-1550AHFC:
 - Run/Jog Switch
 - Clutch Jog push button

Ambient Temperature:

-20° to 122°F (-29° to 50°C)

Auxiliary Supply:

- CBC-500-90 and CBC-500-24
 - 12 VDC, 250 mA maximum

Connection Diagram CBC-1500AHFC

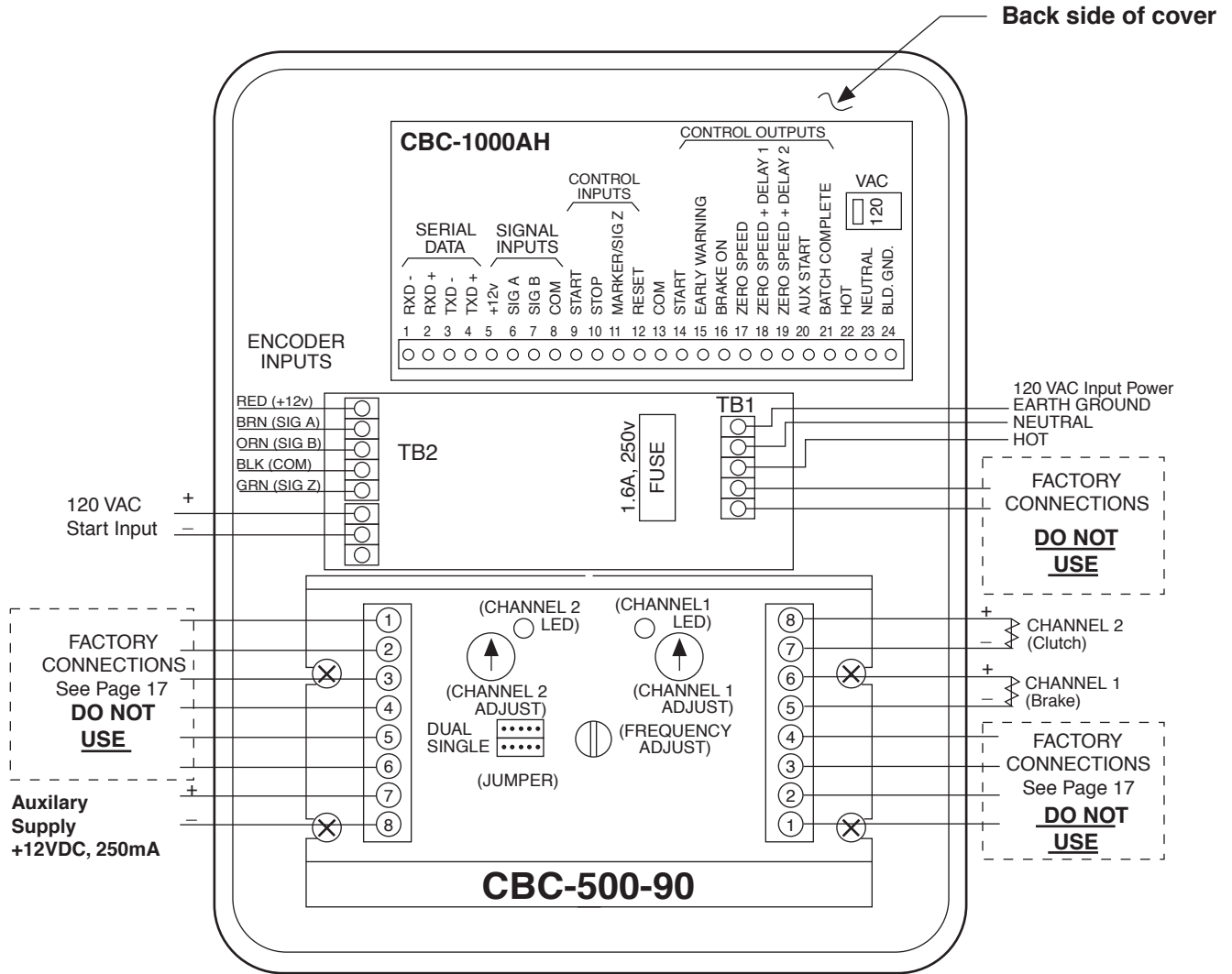

Control Adjustments

CBC-500-90 and CBC-550-24: Channel 1 and Channel 2 Torque Adjustments:

Provides adjustment from 0 to full rated voltage.

Jumper: Allows operation of alternate or simultaneous mode. In the single mode, Channel 1 and Channel 2 function alternately. In the dual mode, Channel 1 and Channel 2 function simultaneously. This mode will be employed in applications with a clutch and failsafe brake.

Frequency Adjustment: Provides adjustment of 60 to 400 HZ to reduce the clutch/brake "hum" associated with machine frequencies.

CBC-1000AH:

Switch Selectable AC Input: Allows for choice of inputting 120 VAC or 240 VAC to unit.

Programming Options: Described on the following pages.

CBC-1500AHFC and CBC-1550AHFC:

Run/Jog Switch: Allows operation in run or jog mode. In run mode the unit will use the motion profile programmed and cycle continuously until interrupted. In jog mode the clutch can be jogged using the clutch jog push button described below.

Clutch Jog Push Button: Causes clutch to rotate when push button is pressed.



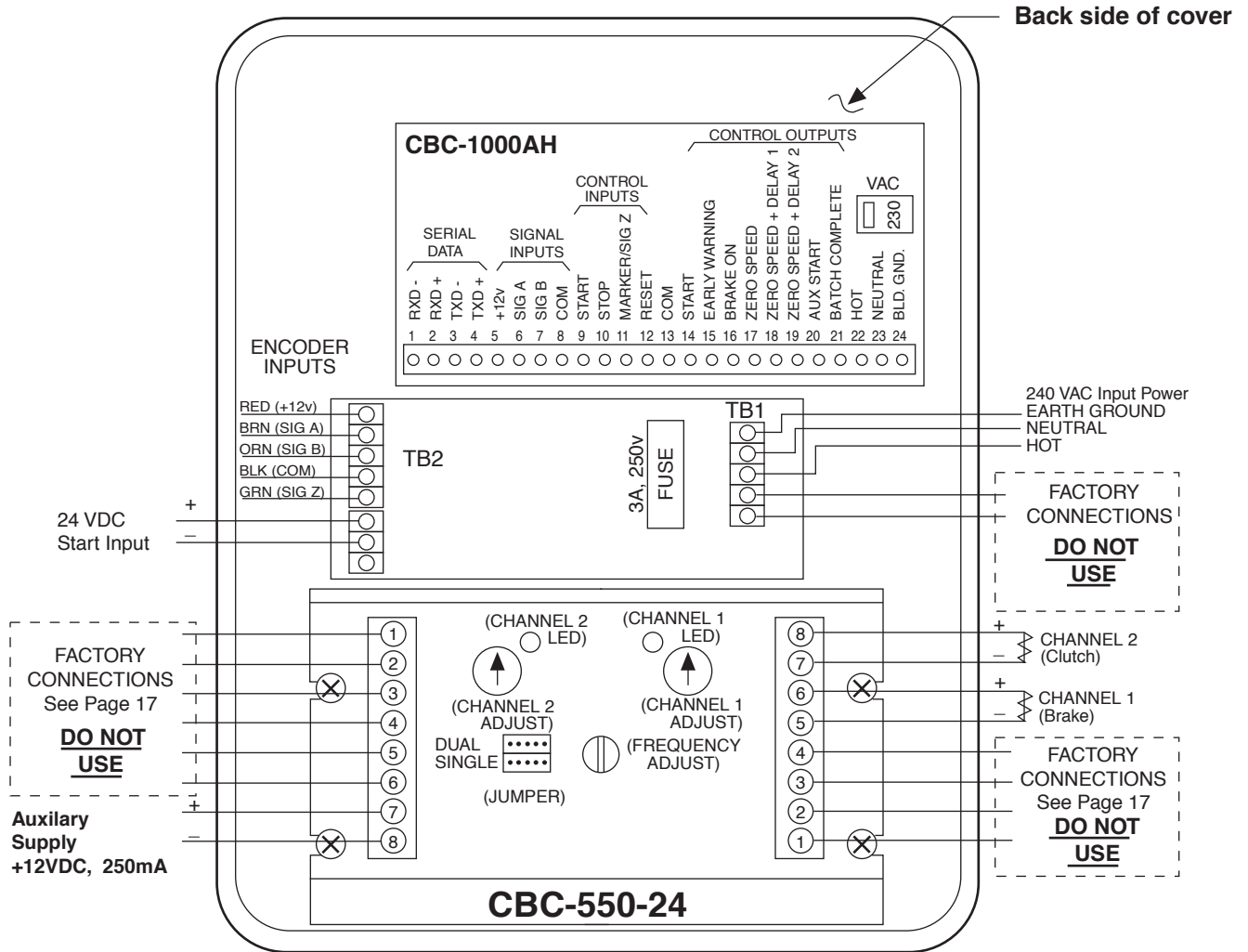



Connection Diagram CBC-1550



CBC-1000AH Control Operation

Successful operation will require knowledge of the following definitions and their relationships to the Timing Diagram below.

Function Key Definitions







Count		The actual move distance, in pulses or scaled into engineering units (inches, feet, rotations, degrees, etc.), displayed dynamically.
Move Preset		The desired move distance in pulses or scaled into engineering units. This is the value the operator enters to select a new move distance. It can also be locked during the RUN mode by simply programming line 6 to "off".
Early Warning		A distance prior to Move Preset at which the early warning output is activated. Expressed as pulses or engineering units, this output can be used to accomplish a soft brake (slow down), energize valves, etc.
Batch*		A cumulative batch counter that can be dynamically displayed to show the number of operations, cycles, etc. When this counter reaches the value programmed by the Batch Preset (key 7) the Batch Complete Output (pin 21 on CBC-1000) is activated. The batch counter can be manually or automatically reset.
Batch Preset*		A programmable batch counter activates the batch complete output when the value programmed has been reached by the batch (key 6).
Braking Distance		The actual distance required to stop. This value is dynamically updated to determine the brake actuation point. Factory default is 25 pulses or engineering units which is only used for the first cycle after power-up. After the first cycle the CBC-1000 will tune to the particular brake being utilized. The amount of cycles needed for tuning depends on how far the true braking distance value is from the default of 25.

* The batch counter is not factory enabled. To utilize, see "Additional Features" section.

Programming

View Presets and Values





The six function keys may all be viewed during the RUN mode. To view their values, press the desired function key and the value is displayed with the corresponding display annunciator. The controller process continues without interruption.

- Press  to display the current length or position (up to six digits).
- Press  to display the move preset (up to six digits).
- Press  to display the early warning preset (up to four digits).
- Press  to display the batch counter (up to six digits).
- Press  to display the batch counter preset (up to six digits).
- Press  to display the average braking distance (up to four digits).



Entering Presets



The three presets (MOV PST, E.W., and BCH PST) may also be changed during the RUN mode provided that programming line 7 (panel lock) is programmed "off". To edit, press the desired preset function key, next press the EDIT key followed by the CLEAR key. Enter the new value using the numeric keys, then press the EDIT key to exit the edit mode and to replace the existing value in memory. The CBC-1000 will use the new number entered after the edit mode is exited.

Move Preset Press , then press , and press , now enter a new value using the numeric keys, then press 

or Press , then press , and press  or  to change the value incrementally, Then press 

Batch Preset Press , then press , and press , now enter a new value using the numeric keys, then press 

Batch Counter Reset To manually reset the batch counter: Press , then press 

System Home To home the system: Press , then press 

Six Simple Setup Steps:

After encoder, clutch/brake, and power connections are made per one of the connection diagrams found on pages 4 and 5:

1. Apply power to unit and move to home position (can use JOG switch). When at home, reset counter to zero.
2. Find home reference number by rotating machine by hand or by jogging and noting the number that is displayed when the 'ref' light on the left/bottom of the display is illuminated. Program this number in memory by entering Program Mode outlined below and inserting number on line 1 (h.). It might take a few tries before you can accurately catch the number on the display when the 'ref' light illuminates.

▲CAUTION No outputs will fire until the home reference number is programmed in.

3. While in Program Mode you will need to turn on Auto Reset, which is line 9. The default can be toggled by pressing the right arrow button. This feature will reset the counter to zero after every cycle.

4. Press the RUN/PGM key to get back to RUN Mode and out of Program Mode. Enter in the Move Preset (MOV PST) value, key 2 (refer to page 6 for instructions on Entering presets). Due to the auto-home feature, the Move Preset must be equal to one revolution of the encoder (600 pulses). The display can be scaled to display any engineering units.

Unit is ready to cycle!

5. After cycling approximately ten times, observe the actual braking distance number (BRK DIS, key 8). Enter the programming mode and place this number in line 2 (bd, initial braking distance). This will ensure that, on power up, the system will take the minimum number of cycles to find home. Check the early warning number entered and make sure that it occurs before the brake output is activated. Also, the home reference number programmed in line 1 must occur before the early warning and brake outputs. If this is not the case, the encoder must be rotated without the machine being rotated to change where the marker pulse occurs. Otherwise, the marker pulse will not be detected because it will occur after the brake has been energized.



Program Mode

To enter the program mode to access the 34 features shown on pages 12 and 13, press the program key and enter the 4-digit password (1000) followed by the down cursor. Note: Before entering the program mode, the stop key or stop input should be activated. The CBC-1000 automatically activates the brake upon entry into the program mode.

To enter the program mode:

Press  , then press     , then press 

 Move down one program line







or press  , then press line number, and press  to jump to the line changing

 Move up one program line

 Select Options

To exit the program: Press 

Programming

Line	Display	Description	Options 	Default	Program
1	h.	Home Reference Number	— — — —	0	
2	bd.	Initial Braking Distance	— — — —	25	
3	bd.AuE.	# of Cycles Averaged	1 - 9	3	
4	cc.	Correction Constant	— — — — —	0.5000	
5	dP.	Decimal Point	off, .0, .00, .000	oFF	
6	FrSt.	Front Panel Reset	on - off	on	
7	PLoc.	Front Panel Lock	on - off	oFF	
8	CrEt.	Count Retention	on - off	oFF	
9	ArSt.	AUTO Reset	on - off	on	
10	ol.	Start Output	00.00 to 99.99	00.20	
11	o2.	Early Warning Output	00.00 to 99.99	00.01	
12	o3.	Brake on Output	00.00 to 99.99	00.20	
13	o4.	Zero Speed Output	00.00 to 99.99	00.10	
14	o5.	Zero Speed + Delay 1	00.00 to 99.99	00.05	
15	o6.	Zero Speed + Delay 2	00.00 to 99.99	00.05	
16	o8.	Batch Counter Reset	00.00 to 99.99	LATCH	
17	dl.	Delay Time 1	00.00 to 99.99	00.10	
18	d2.	Delay Time 2	00.00 to 99.99	00.01	
19	05P.	Zero Speed Window	.01, .05, .10, .25 sec.	.25	
20	5	Start Command Release	Outputs 1-6 .no change d .drop out	— — — — —	
21	L	Move Preset Release	Outputs 1-6 .no change d .drop out	— — — — —	
22	E	Early Warning Release	Outputs 1-6 .no change d .drop out	— — — — —	
23	r	Reset Command Release	Outputs 1-6 .no change d .drop out	— — — — —	
24	br.	Baud rate	off, 300, 600, 900 1200, 2400	oFF	
25	PAr	Parity	nonE, odd, EuEn	nonE	
26	id.no.	Identification Number	0 - 99	0	
27	t0.	Keyboard Test	rdy	y	
28	tl.	Non-Volatile RAM Test	Press 	y	
29	t2	Input Test	Ab - encoder inputs 1 - start 2 - stop 3 - cont. 4 reset	y	Refer to Diagnostics Test Page 9
30	t3	Output Test	1 - E	y	
31	t4	Display Test	Press 	y	
32	t5	Program Memory Test	Press 	y	
33	t6	Date Code Test	Press 	y	
34	t7	Serial Test	Press 	y	
35	t8	Factory Default Settings	Press 	y	

Programming

Line	
1	The number that is downloaded to the display when the marker pulse is detected.
2	The first brake distance used by the CBC-1000 at power-up.
3	The number of cycles used for the running average of brake distance.
4	The scaling factor for the front panel display (0.5000 for display in pulses).
5	Number of decimal points displayed. Affects all distance values in other registers.
6	Enables or disables front panel reset in the Run Mode.
7	"On" enables and "Off" disables changing MOV PST, E.W., and BCH PST while running.
8	Retains system position during power off.
9	Select Absolute (ON) or Incremental (OFF) mode of operation.
10	The duration (momentary or latched) of the Start Output in seconds. For latched input, enter all zeros or press 
11	The duration (momentary or latched) of the Early Warning output in seconds.
12	The duration (momentary or latched) of the Brake On output in seconds.
13	The duration (momentary or latched) of the Zero Speed output in seconds.
14	The duration (momentary or latched) of the Zero Speed + Delay 1 output in seconds.
15	The duration (momentary or latched) of the Zero Speed + Delay 2 output in seconds.
16	Momentary for automatic (internal) reset or latched for manual (operator) reset.
17	The delay time for Zero Speed + Delay 1 output in seconds.
18	The delay time for Zero Speed + Delay 2 output in seconds.
19	The time window in seconds to determine Zero Speed. Zero Speed equals no pulses received within window.
20	Releases latched outputs at the start command. Press 1-6 on the front panel to release or drop output.
21	Releases latched outputs at the move preset. Press 1-6 on the front panel to release output or drop output.
22	Releases latched outputs at the Early Warning signal. Press 1-6 on the front panel to release output or drop output.
23	Releases latched outputs at reset. Press 1-6 on the front panel to release output or drop output.
24	See Serial Interface section.
25	See Serial Interface section.
26	Control identification number. See Serial Interface section. See Diagnostic Tests on page 15 for further information on diagnostic tests listed below.
27	Front panel keyboard test.
28	Non-Volatile RAM test.
29	Control input test.
30	Control output test.
31	Front panel display test.
32	Control program memory test.
33	Displays Date Code of CBC-1000 software.
34	Control serial test.
35	Returns control to factory default settings.

CBC-1500AHFC and CBC-1550AHFC Program for Fast Cycling Feature

Line	Program
1	275
2	25
3	3
4	0.5
5	OFF
6	ON
7	OFF
8	OFF
9	ON
10	0.1
11	0.01
12	0.1
13	0.07
14	0.05
15	0.05
16	LATCH
17	0.1
18	0.01
19	0.05
20	-----
21	-----
22	-----
23	-----
24	OFF
25	NONE
26	0
27	Y
28	Y
29	Y
30	Y
31	Y
32	Y
33	Y
34	Y
35	Y

Function Key	Program
Count	USER CAN'T EDIT
Move Preset	600
Early Warning	0
Batch	XX Does not Matter
Batch Preset	XX Does not Matter
Braking Distance	USER CAN'T EDIT

CBC1500AHFC and CBC1550AHFC

Normal Cycle:

- A) Brake is engaged.
- B) The CBC1500AHFC receives a “start input” from external control.
- C) The CBC1500AHFC sends a “start output” that turns on the clutch.
- D) The encoder starts rotating and display starts counting positive numbers. If display counts negative numbers, swap encoder inputs Sig. A and Sig. B.
- E) The CBC1500AHFC receives an “encoder index mark” and matches the “CBC1000 count” with the system count (CBC1500AHFC count). The “CBC1000 count” goes back to the home reference preset number.
- F) When the “CBC1500AHFC count” is equal to (600 minus the braking distance), the CBC1500AHFC sends a “stop output,” which turns on the brake. The system will have a soft stop. The torque of the brake can be adjust via potentiometer on the CBCSOO control.
- G) System arrives to a complete stop at 600 pulses.
- H) When the encoder stops turning, the CBC1000 sends a “zero speed” output to the microcontroller.

Fast cycle:

- 1) Brake is engaged.
- 2) The CBC1500AHFC receives a “start input” from external control.
- 3) The CBC1500AHFC sends a “start output” that turns on the clutch.
- 4) The encoder starts rotating and display starts counting positive numbers. If display counts negative numbers, swap encoder inputs Sig. A and Sig. B.
- 5) The CBC1500AHFC receives the “encoder index mark” and matches the CBC1000 count with the CBC1500AHFC count.
- 6) The CBC1500AHFC receives a second “start input” from external control.
- 7) When the CBC1500AHFC count arrives to 600, microcontroller disables the encoder input to the CBC1000.

- 8) The CBC1000 stops counting. The display will stop counting for a short period of time.
- 9) After .05 seconds, CBC 1000 sends a “zero speed” output to the microcontroller.
- 10) The microcontroller enables the encoder input to the CBC1000.
- 11) The CBC1000 starts counting. AT THIS POINT THE CBC1000 COUNT DOES NOT MATCH THE SYSTEM’S COUNT. THE DISPLAY COUNT DOES NOT MATCH THE SYSTEM COUNT.
- 12) The CBC1500AHFC receives an “encoder index mark” and matches the “CBC1000 count” with the system count (CBC1500AHFC count). The “CBC1000 count” goes back to the home reference preset number. After the display changes, the CBC1500AHFC will be capable to receive a new “start input.” That is why the encoder needs to be placed with the encoder mark on the first 90 degrees of system rotation.
- 13) When the “CBC1500AHFC count” is equal to (600 minus the braking distance), the CBC1500AHFC sends a “stop output,” which turns on the brake. The system will have a soft stop. The torque of the brake can be adjusted via potentiometer on the CBC500 control.
- 14) The system arrives to a complete stop at 600 pulses.
- 15) When the encoder stops turning, the CBC1000 sends a “zero speed” output to the microcontroller.

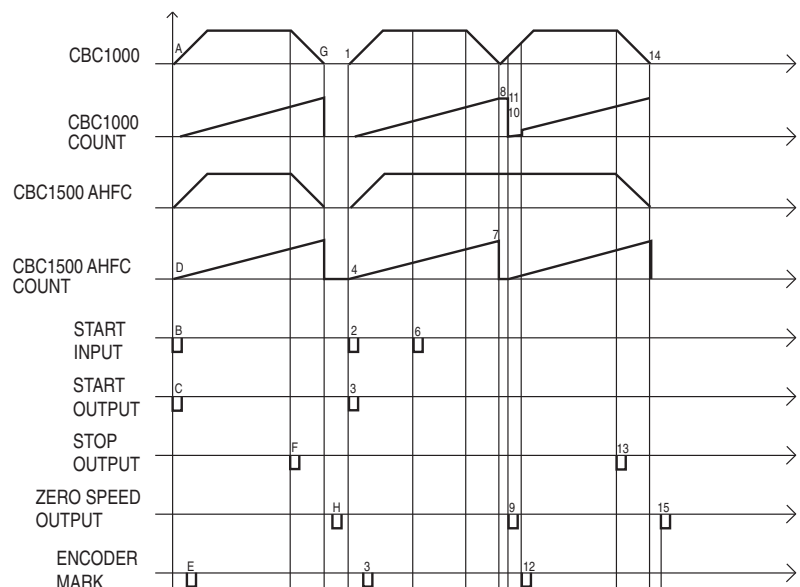

Additional Features

These features are available on the current unit, but some extra hardware or programming is needed to enable them.

Batch Counter:

This feature will trigger the Batch Complete output, pin 21, when the Batch Preset, key 7, reaches the Batch Counter, key 6, value (refer to Entering presets, page 6, to enter a value in the Batch Preset). The Batch Counter can be manually or automatically reset. Manual reset is the default setting in the program mode line 16 (08. latch). To automatically reset the Batch Counter, set the Batch Counter Reset line 16 in Program Mode to Momentary (00.01 to 99.99 seconds). This will hold the Batch complete output terminal 21 active for the time programmed and reset the Batch Counter.

E-Stop:

By maintaining a contact closure between COM, terminal 13 and Stop terminal 10, no inputs will be received or outputs fired. This can be used as a safety feature to make sure a start will not occur while some other process is taking place.

Display Scaling (Program Line 4)

- **Changing the CC & decimal point will affect presets**
- **CC should not exceed 1.0**
- **CC of .5 displays encoder pulses**

The display can be easily scaled to display engineering units (inches, meters, degrees, rotations, etc). Line 4 of the programming (correction constant) prompts input of a factor (five decades) that will be multiplied times the incoming pulse train to display the desired engineering units. Remember that the CBC-1000 includes a times 2 internal multiplier effectively doubling the resolution of a given encoder. Thus, if one wishes to view encoder pulses, a multiplier (correction constant) of '0.5' should be entered on Line 4 in the programming mode. The resolution of the encoder should be chosen to take advantage of the best instantaneous accuracy of the calibrator. The best instantaneous accuracy is obtained with a correction constant setting not exceeding 1.0000. The scaled units are also used to measure stop and move distances. Consequently, the scaled units selected affect the system resolution. For example, with the correction constant set for display at 1.0 inches, is the smallest measurable increment. Remember, the decimal point must be programmed (programming line 5) to display the desired display resolution. This resolution is also used in the denominator of the correction constant equation. The general form of the equation for the correction constant is given below.

$$\text{CC (Correction Constant)} = \frac{\text{Distance traveled in engineering units per one revolution of the encoder}}{\text{Display Resolution Desired} \times \text{Encoder Resolution} \times 2}$$



(0.001, 0.01, 0.1, 1.0)

Example: Web measurement - Display in inches, display resolution in tenths of an inch
Encoder Resolution - 600 PPR
Mounting - Direct, via 4" diameter wheel

Calculation: $cc = \frac{2\pi r = (2)(\pi)(2) = 12.5664}{0.1 \times 600 \text{ pulses/revolution} \times 2} = 0.1047$

CBC-1000 Diagnostic Tests



t0: Keyboard Test: Tests the function of the front panel keys.

Press  to begin test. RUN: will be displayed. Press each front panel key except  to test key. The display will indicate if the key is functional.



t1: Non-Volatile RAM Test: Tests CBC-1000 RAM.

Press  to begin test. The test will return PASS or FAIL. Press  to continue.



t2: Input Test: Tests whether CBC-1000 is accepting inputs.

Press  to begin test. Activate inputs to control. If the input is received, a character will be displayed. "Ab" - Encoder input, "1" - Start, "2" - Stop, "3" Continuous mode, "4" Reset. Press  to continue.

t3: Output Test: Used to determine whether CBC-1000 outputs are functional.

Press  to begin test. Press keys 1-6 on the front panel. The corresponding output will turn on and latch. Use a VOM to check for a high level state on terminal strip of CBC-1000. Press  to exit test.

t4: Display Test: Tests function of each LED on front panel.

Press  to begin test. Each digit of front panel display will automatically be turned on. Check for faulty LEDs. Press  to continue.

t5: Program Memory Test: Tests program memory capability.

Press  to begin test. PASS or FAIL will be returned. Press  to continue.

t6: Date Code Test: Displays software date code.

Press  to display date code. Press  to exit. Continue





t7: Serial Test: Tests connections with serial data interface module.

Press  to begin test. PASS or FAIL will be displayed. Press  to continue.

t8: Factory Default Settings: Returns CBC-1000 to factory settings.

Press  to return all program steps to factory default settings.

Troubleshooting

Problem	Solution
Machine starts but does not stop	<ul style="list-style-type: none"> • Establish a move Preset • Ensure brake functions properly using output test. • Make sure the marker pulse is detected before brake outputs fire.
Machine stops out of position	
Display counts backwards	<ul style="list-style-type: none"> • Reverse Encoder A, B, wiring.
Machine stops abruptly, not a soft stop	<ul style="list-style-type: none"> • Turn down torque adjust potentiometer for Channel 1.
Machine stops but then restarts	<ul style="list-style-type: none"> • Control may be responding to a start command. Check for transient signals. Use the E-Stop feature described in "Additional Features" to disable a start input.
Control appears to function perfectly but the actual error is greater than the display indicates.	<ul style="list-style-type: none"> • Check for slippage between the encoder and the manual items.
Display not counting	<ul style="list-style-type: none"> • Check encoder connections. If good connections exist, send encoder for repair.
Control accumulates too many counts. Home or zero position is drifting.	<ul style="list-style-type: none"> • Check Display Scaling, page 10, and check for electrical noise, such as ground loops. Eliminate noise.
Control appears to work but proper motion is not occurring.	<ul style="list-style-type: none"> • Review Clutch Brake and Control Service Manuals. Use Output Test (line 30) to verify performance.
System does not operate and fails diagnostic Tests 1,3, 4, 5 or 7. Reference page 15.	<ul style="list-style-type: none"> • Return unit for repair, call an Authorized Warner Electric Distributor.
System stops, but does not fire outputs.	<ul style="list-style-type: none"> • Lower zero speed window (line 19) to minimize effects of encoder "bounce" caused by vibrations.
'Ref' light not illuminating every cycle.	<ul style="list-style-type: none"> • A lower resolution encoder may be needed. Call factory for more information.
Error Codes	
If an error message appears	<ul style="list-style-type: none"> • Disconnect power to CBC-1000 momentarily and error should clear. Press  to clear error code.
Error Code 2 - Low Line Voltage.	<ul style="list-style-type: none"> • Correct line voltage. Press  to clear error code.
Error Code 3 - Feedback too fast.	<ul style="list-style-type: none"> • Reduce encoder resolution and/or speed to keep encoder feedback less than 20,000 PPS. Press  to clear error code.
Error Code 4 - Process Time fully utilized	<ul style="list-style-type: none"> • Reduce encoder resolution or consult factory. Press  to clear error code.

Electrical Diagram

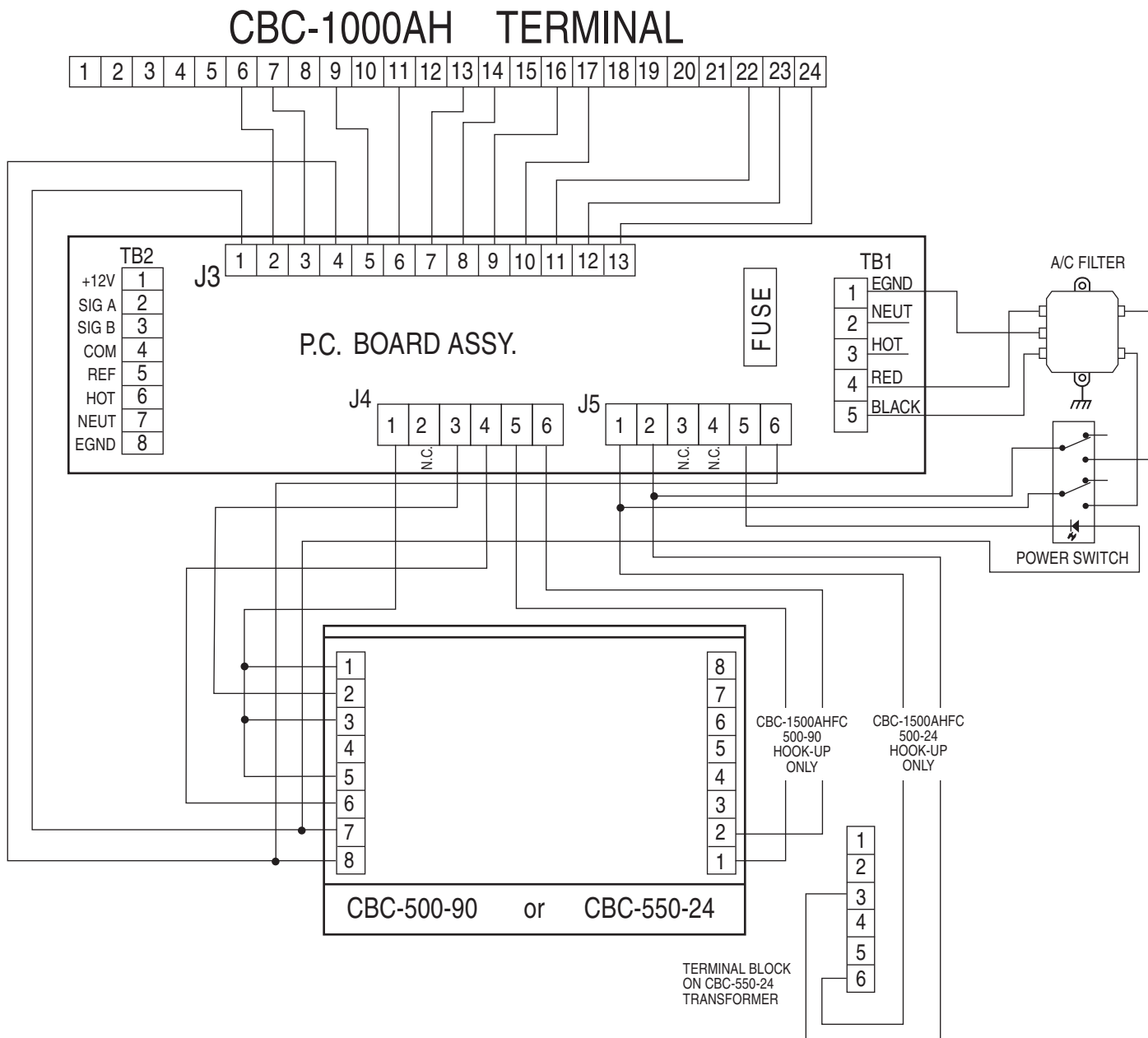

Dimensional Diagram

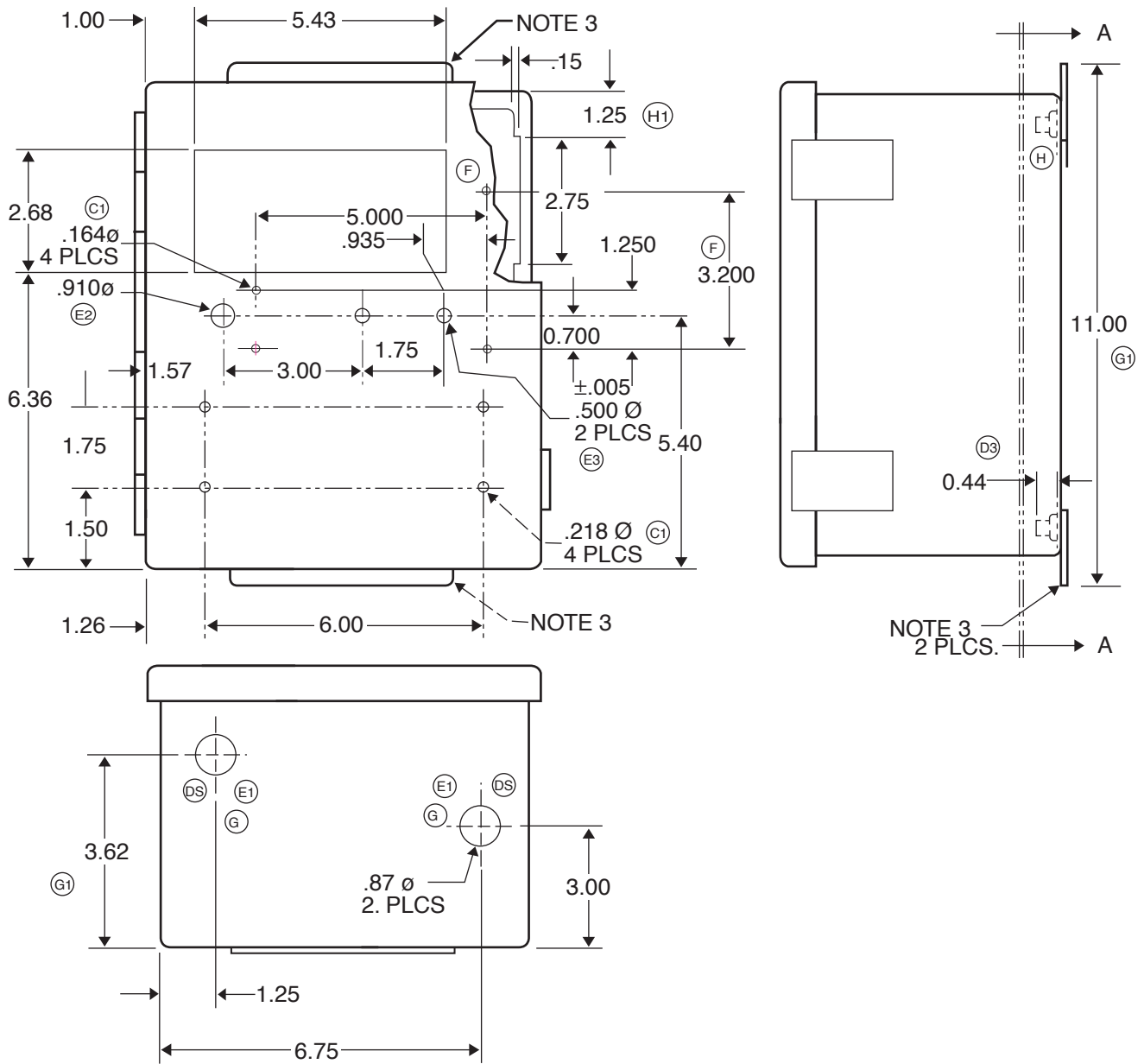

Dimensional Diagram

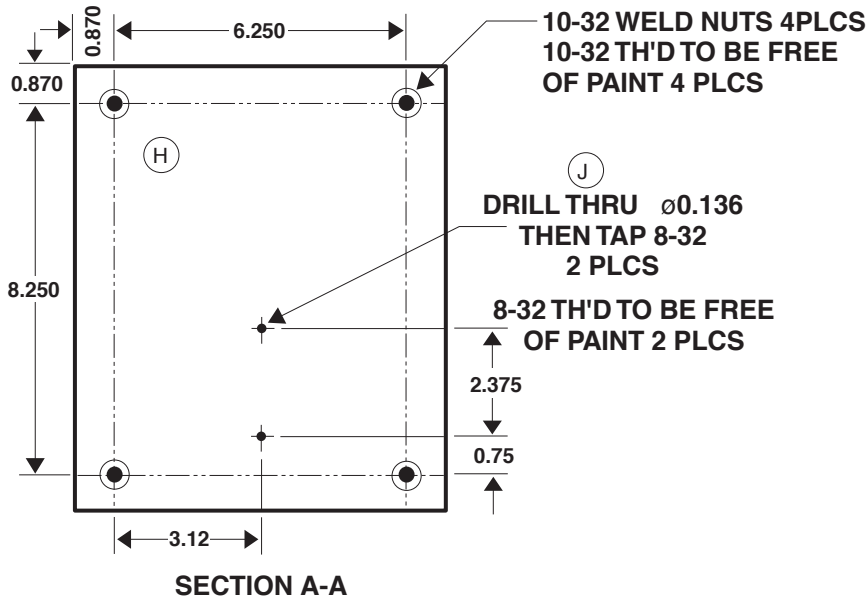
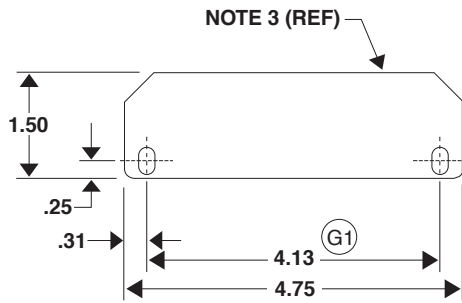

- (D2) 1.) WELD NUTS 4 PLACES AS SHOWN OHIO NUT
& BOLT CO. P/N WF 1405 OR EQUIV.
- 2.) ENCLOSURE TO BE 10X8X6 SIMILAR TO HOTTMAN P/N
A-10086CH W/COLOR BLACK POLY POWDER COAT.
- (D4) 3.) ENLARGE FOUR MOUNTING SLOTS FROM .22X.28LG TO .25X.375LG.

CBC1500AHFC and CBC1550AHFC Revision B Installation Procedure

⚠ WARNING To prevent personal injury, ensure all personnel are clear of conveyor line and the pusher before performing any adjustments on the control.

Programming Adjustments

1. Turn on the power switch of the control. The power switch should illuminate.
2. **On the control display, press #2 (MOV-PST). The number 600 should be displayed on the LED display. If any other number is displayed, do the following:**
 - a) Press “EDIT” (the word edit should be displayed on the LED display).
 - b) Press “CLEAR” (all numbers should reset to zero).
 - c) Enter 600.
 - d) Press “EDIT” (the word edit should turn off).
3. Press #1 (COUNT) on the control.
4. Set the toggle switch on the control marked RUN/JOG to JOG position.
5. Press the “CLUTCH-JOG” switch and release immediately. Make sure the pusher is moving in the right direction for its configuration. If not, remove power from the system (including power from the motor) and swap the motor phase wires.

Note: If the control is counting negative numbers, swap Signal A and Signal B inputs in the Warner Electric control.

6. Jog pusher until the long arm is straight and both paddles are inside the pusher enclosure.
7. Press #1 (COUNT) on the control.
8. Press “CLEAR” (all numbers should reset to zero).
9. Jog the pusher slowly as you watch the lower left side of the display. When you see “ref” light come on, stop and note what number is in the display. This is your “home reference”. The “home reference” will have to be entered into the control in a later step.

Note: The “ref” light must be seen between 100 and 500 pulses. If the “ref” signal is not seen until beyond this range, the encoder will have to be dismounted rotated left or right 90 degrees and remounted. Once the encoder has been remounted repeat step #9.

10. On the control display, press “RUN/PGM”.
11. Enter 1000.
12. Press the down arrow.
13. The first line of the program should be displayed, showing the home reference “h” and a value (this value could be zero).
14. Press “CLEAR”.
15. Enter the “home reference” you recorded in step #9.
16. Press the arrow down key.

bd	(25 to 75)	Braking distance average
----	-------------------	--------------------------
- | | | | |
|---------------------|----|----|--------------------------------|
| Press “RESET/CLEAR” | bd | 0 | Clearing to set new value |
| Press key 6. | bd | 60 | Braking set: 60 encoder pulses |
17. Press the arrow down key.

bd. AuE. 3	Number of cycles averaged = 3
-------------------	-------------------------------
18. Press the arrow down key.

cc. 0.5000	Count Correction Feature
-------------------	--------------------------
19. Press the arrow down key.

dP. off	Decimal Point Feature is off.
----------------	-------------------------------
20. Press the arrow down key.

FrSt. on	Front panel reset is enabled.
-----------------	-------------------------------
21. Press the arrow down key.

PLoc. off	Front panel lockout is off.
------------------	-----------------------------
22. Press the arrow down key.

CrEt. off	Count retention should be off.
------------------	--------------------------------
- | | | |
|----------------------------|-----------|----------------------------------|
| If it says CrEt on: | | |
| Press the arrow right key. | CrEt. off | Count retention is now back off. |
23. Press the arrow down key.

ArSt. on	Auto reset should be on.
-----------------	--------------------------
- | | | |
|------------------------------|----------|----------------------------|
| If it says ArSt. Off: | | |
| Press the arrow right key. | ArSt. on | Auto reset is now back on. |
24. Press the arrow down key.

01 00.20	Start signal of 200ms.
-----------------	------------------------
- | | | |
|---------------------|----|-------|
| Press “RESET/CLEAR” | 01 | LAtch |
| Press key 2. | 01 | 00.02 |

- | | | | | |
|-----|--|------------|--------------|-------------------------------------|
| | Press key 0. | 01 | 00.20 | |
| 25. | Press the arrow down key. | 02 | 00.01 | Early warning signal, not used. |
| | If it is not 00.01: | | | |
| | Press "RESET/CLEAR" | 02 | LAtch | |
| | Press key 1. | 02 | 00.01 | |
| 26. | Press the arrow down key. | 03 | 00.20 | Stop signal of 200ms. |
| | If it is not 00.20: | | | |
| | Press "RESET/CLEAR: | 03 | LAtch | |
| | Press key 2. | 03 | 00.02 | |
| | Press key 0. | 03 | 00.20 | |
| 27. | Press the arrow down key. | 04 | 00.10 | Zero speed signal of 100ms. |
| | If it is not 00.10: | | | |
| | Press "RESET/CLEAR" | 04 | LAtch | |
| | Press key 1. | 04 | 00.01 | |
| | Press key 0. | 04 | 00.10 | |
| 28. | Press the arrow down key. | 05 | 00.05 | Zero speed signal plus 50ms. |
| | If it is not 00.05: | | | |
| | Press "RESET/CLEAR" | 05 | LAtch | |
| | Press key 5. | 05 | 00.05 | |
| 29. | Press the arrow down key. | 06 | 00.05 | Zero speed plus second 50ms. |
| | If it is not 00.05: | | | |
| | Press "RESET/CLEAR" | 06 | LAtch | |
| | Press key 5. | 06 | 00.05 | |
| 30. | Press the arrow down key. | 08 | LAtch | Batch counter auto reset |
| 31. | Press the arrow down key | d1 | 0.10 | Zero speed delay #1 |
| | If it is not 0.10: | | | |
| | Press "RESET/CLEAR" | d1 | 0.00 | |
| | Press key 1. | d1 | 0.01 | |
| | Press key 0. | d1 | 0.10 | |
| 32. | Press the arrow down key. | d2 | 0.01 | Zero speed delay #2. |
| | If it is not 0.01: | | | |
| | Press "RESET/CLEAR" | d2 | 0.00 | |
| | Press key 1. | d2 | 0.01 | |
| 33. | Press the arrow down key. | 05P | .25 | Zero speed window of 250ms |
| | If it is not .25: | | | |
| | Press the arrow right key. | 05P | .25 | (Keep pressing right key until .25) |
| 34. | Press the "RUN/PGM" key. | | 0 | |
| 35. | Make sure pusher is at the "home position." | | | |
| 36. | Toggle the "RUN/JOG" switch to RUN position. | | | |
| 37. | Press #1. | | | |
| 38. | Press "CLEAR". | | | |
| 39. | Press the yellow start button one time (on the control). The pusher should make one complete cycle and stop near the "home reference". | | | |
| 40. | Cycle the pusher ten times with the yellow button. Notice that the pusher will increase accuracy each cycle. | | | |
| 41. | If pusher appears to be cycling properly after 10 cycles, press button #8 on the control. Note this number. | | | |
| 42. | Stop cycling. Press "RUN/PGM". | | | |
| 43. | Enter 1000. | | | |
| 44. | Press the down arrow. The display shows the "home reference". | | | |
| 45. | Press the down arrow. The display shows the "braking distance" (db). | | | |
| 46. | Press "CLEAR". | | | |
| 47. | Enter the "braking distance" you recorded in step #58. | | | |
| 48. | Press "RUN/PGM". | | | |

This completes all the programming of the Warner Electric control.

Common Terminology

1. Home position. – Long arm is straight and both paddles are inside the pusher enclosure.
2. Home reference. – Position of the pusher’s arm when the “ref” indicator on the display is illuminated.
3. Move preset. – Number of pulses that the control is going to count in each cycle. For this application it is 600 pulses.
4. Early Warning. – A distance prior to Move Preset at which the early warning output is activated. The early warning is not used in Revision A or Revision B.
5. Count. – The actual “move distance” in pulses. This parameter changes from 0 to 600 when the pusher is cycling.
6. Test number 8. – In the programming options, there is a “test number 8” in line 35. This test will erase all the parameters in the control and will set everything to factory set. Factory set is not the program that the pusher requires. If “test #8” is activated by accident, repeat all the programming steps in this document.

Torque Adjustments

1. Open the Warner Electric control.
2. Locate the CBC500 driver board on the CBC1550AHFC; or locate the CBC550 on the CBC1550AHFC.
3. Locate two small potentiometers near the indicator lights.
4. Adjust the torque on the brake or clutch via these potentiometers.

Note: If torque adjustments are made after programming, repeat programming sequence starting on step #52.

How to reset the program defaults:

If program is all messed up: (cc = 1.000 for instance) step 18

Action	Result	Should See	Comment
1. Press the “RUN/PGM” key.		Loc. 0	Opens program
2. Press 1, 0, 0, 0		Loc. 1000	
3. Press and hold arrow down key until T8 is displayed.		t8. rdy	This is the very last step in the program.
4. Press the arrow right key	it will flash	t8. run	Program settings defaulted now.
5. Press the “RUN/PGM” key.		0	Unit is ready for reprogramming.
6. Unit must now be reprogrammed.	Go to step 10.		Steps 10 thru 51.

Warranty

Warner Electric, Inc. warrants that it will repair or replace (whichever it deems advisable) any product manufactured and sold by it which proves to be defective in material or workmanship within a period of one (1) year from the date of original purchase for consumer, commercial or industrial use.

This warranty extends only to the original purchaser and is not transferable or assignable without Warner Electric, Inc.'s prior consent.

Warranty service can be obtained in the U.S.A. by returning any defective product, transportation charges prepaid, to the appropriate Warner Electric, Inc. factory. Additional warranty information may be obtained by writing the Customer Satisfaction Department, Warner Electric, Inc., 449 Gardner Street, South Beloit, Illinois 61080, or by calling 815-389-3771.

A purchase receipt or other proof of original purchase will be required before warranty service is rendered. If found defective under the terms of this warranty, repair or replacement will be made, without charge, together with a refund for transportation costs. If found not to be defective, you will be notified and, with your consent, the item will be repaired or replaced and returned to you at your expense.

This warranty covers normal use and does not cover damage or defect which results from alteration, accident, neglect, or improper installation, operation, or maintenance.

Some states do not allow limitation on how long an implied warranty lasts, so the above limitation may not apply to you.

Warner Electric, Inc.'s obligation under this warranty is limited to the repair or replacement of the defective product and in no event shall Warner Electric, Inc. be liable for consequential, indirect, or incidental damages of any kind incurred by reason of the manufacture, sale or use of any defective product. Warner Electric, Inc. neither assumes nor authorizes any other person to give any other warranty or to assume any other obligation or liability on its behalf.

WITH RESPECT TO CONSUMER USE OF THE PRODUCT, ANY IMPLIED WARRANTIES WHICH THE CONSUMER MAY HAVE ARE LIMITED IN DURATION TO ONE YEAR FROM THE DATE OF ORIGINAL CONSUMER PURCHASE. WITH RESPECT TO COMMERCIAL AND INDUSTRIAL USES OF THE PRODUCT, THE FOREGOING WARRANTY IS IN LIEU OF AND EXCLUDES ALL OTHER WARRANTIES, WHETHER EXPRESS OR IMPLIED BY OPERATION OF LAW OR OTHERWISE, INCLUDING, BUT NOT LIMITED TO, ANY IMPLIED WARRANTIES OF MERCHANTABILITY OR FITNESS.

Some states do not allow the exclusion or limitation of incidental or consequential damages, so the above limitation or exclusion may not apply to you. This warranty gives you specific legal rights and you may also have other rights which vary from state to state.

Changes in Dimensions and Specifications

All dimensions and specifications shown in Warner Electric catalogs are subject to change without notice. Weights do not include weight of boxing for shipment. Certified prints will be furnished without charge on request to Warner Electric.



Warner Electric LLC
31 Industrial Park Road • New Hartford, CT 06057
815-389-3771 • Fax: 815-389-2582
www.warnerelectric.com