

Rugged Duty Actuator AC Motor Acme Screw



Up to 1,100 lbs. (4893 N) Rated Load
Up to 1 in. (25.4mm)/sec. Travel Speed

The K2 is the base model in the B-Track family. It incorporates a patented in-line load transfer design which provides high load capability for rugged-duty use, efficient power use, compact package size, excellent corrosion and washdown protection, and high performance synthetic lubrication for life, all at an affordable price.

The K2 uses a solid bronze or Delrin® nut with a rolled hybrid screw yielding high impact capability and long screw life. Heavy-duty double-ended ball bearing motors, hardened gears, O-ring seals and an extension rod bearing system that provides best in class capabilities.

Now Available Optional Adjustable Limit Switch These easy to use adjustable switches are mounted in a channel on the cover tube with custom cap for protection. They are easily moved to enable the end-user the flexibility of setting the stroke length at any position within the full stroke capability.

Features

- **Protective coatings** and O-ring seals throughout
- **Patented in-line load system**
- **Hybrid nut and screw** design, no brake needed
- **Ball detent overload clutch**
- **Stroke lengths** 4 to 24 inches (100 to 600 millimeters)
- **Load capacities** up to 1100 pounds (4893 N)
- **Speeds up to** 1 inches (25.4 millimeters)/sec. travel
- **Thermal overload** incorporated into the motor
- **Heavy wall construction**
- **Double ball bearing motors**
- **Heat treated gears**
- **Rugged extension rod** bearing support
- **Custom mounting** options available
- **Limit switches** offered only in the adjustable version (EP1.x)

Typical Applications

- Ergonomic lift tables
- Roof vents
- Conveyor diverters
- Bin/tank cover lifts



Scan to watch!

How to Adjust the Limit Switches for a K2 or K2X Actuator with External or EP Limit Switches
<https://p.widencdn.net/imzc9v>

Load/Current/Speed/Duty Cycle

- Maximum Static Rating: 3,000 lbs. (13345 N) Static (in-line load)
- Refer to performance chart for load/current/speed capabilities
- Stroke Length Tolerance: +/- .06" (1.52 mm)
- Motor is protected with auto reset breaker inside motor housing (temperature/current/time dependent)
- Overload clutch setting: +25% over rated dynamic load
- Duty cycle is time/temperature/load dependent, suggested guidelines are:
 - 50% max on-time/50% off-time for loads up to 50% of capability
 - 25% max on-time/75% off-time for loads between 50%-80% of capability
 - 10% max on-time/90% off-time for loads between 80%-100% of capability

(Load/stroke profiles will allow some adjustment variation from these guidelines.)

Operating Environment

- Ambient temp range:
 - 20° F to +150° F (-29° C to +65° C),
 - 40° F to +176° F (-40° C to +80° C) Upon Request.
- Weather resistant enclosure & seals (IP 54 capable, 250 hour salt spray, 500 hour for paint)
- Normal operating voltage: 115 VAC or 230 VAC

Control/Connections

- 14 gauge stranded lead wires-UL style 1230 w/PVC insulation Class F 105° C
- Use momentary contact switch in powering unit for extend/retract operation.
(ON)-OFF-(ON) SPDT

Dimensions

| B-Track K2Ac | Stroke | in. | mm | in. | mm | in. | mm | in. | mm | in. | mm | in. | mm |
|-----------------|--------|-------|-------|-------|-------|-------|-------|-------|-------|-------|-------|-------|-------|
| | | 4 | 100 | 6 | 150 | 8 | 200 | 12 | 300 | 18 | 450 | 24 | 600 |
| | A | 14.96 | 380.0 | 16.97 | 431.0 | 18.94 | 481.1 | 22.95 | 582.9 | 28.94 | 735.1 | 34.92 | 887.0 |

Note: Special lengths available

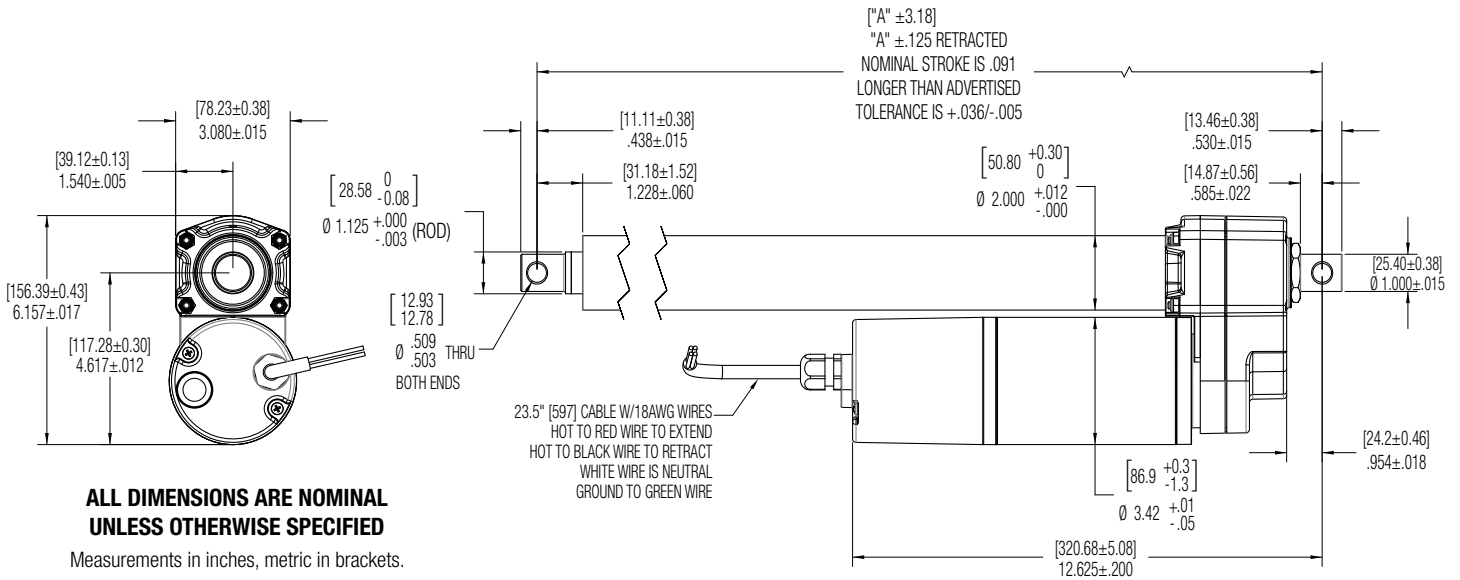

B-Track K2AC

Performance Graphs Imperial Measurements*

*Performance Chart Measurements are Nominal

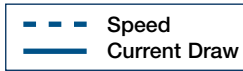

Load Capacity 500 lbs.

For Metric Measurements, see page 35.

K2G10-115VAC

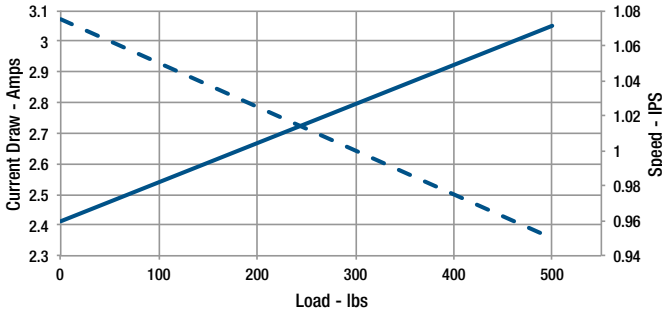

K2G10-230VAC

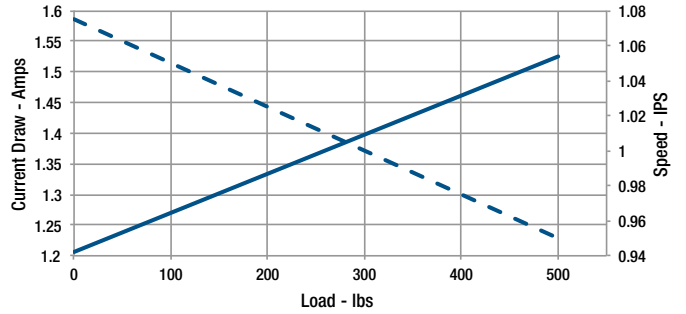

Load Capacity 750 lbs.

For Metric Measurements, see page 35.

K2G20-115VAC

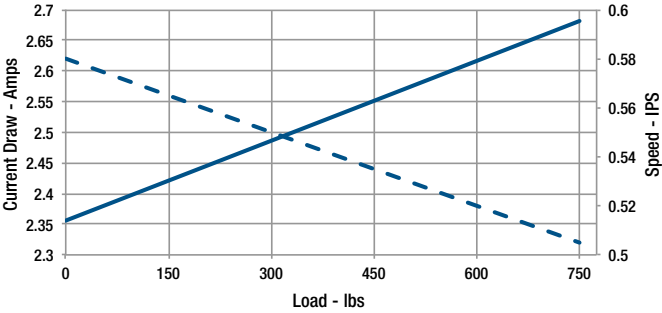

K2G20-230VAC

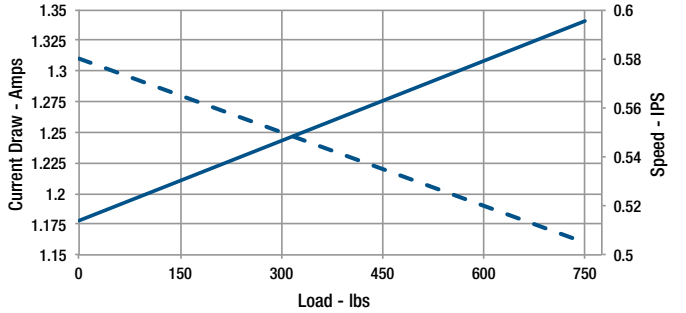

Load Capacity 1100 lbs.

For Metric Measurements, see page 35.

K2G30-115VAC

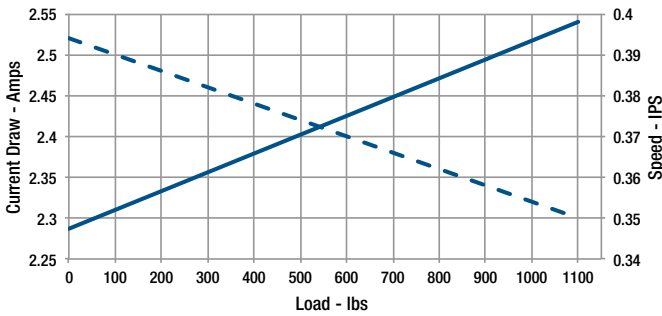

K2G30-230VAC

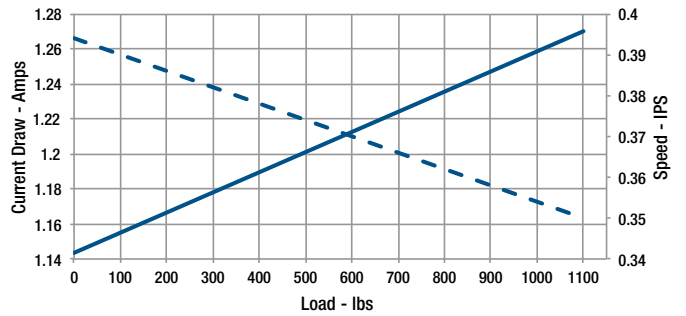

Performance Graphs Metric Measurements*

*Performance Chart Measurements are Nominal

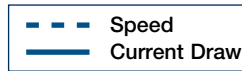

Load Capacity 2225 N

For Imperial Measurements, see page 34.

K2G10-115VAc

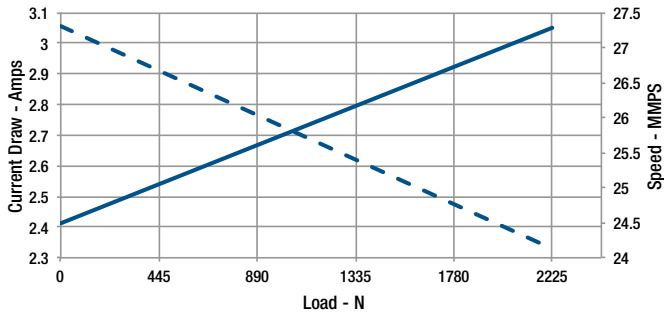

K2G10-230VAc

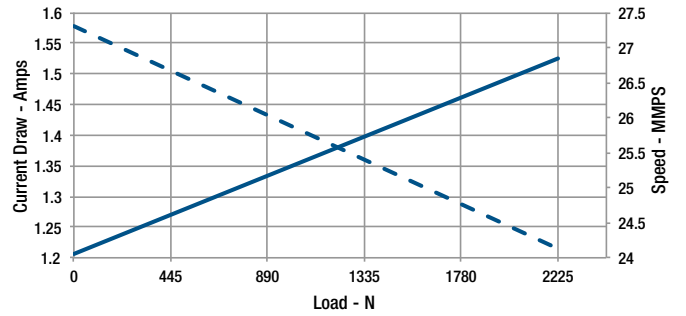

Load Capacity 3338 N

For Imperial Measurements, see page 34.

K2G20-115VAc

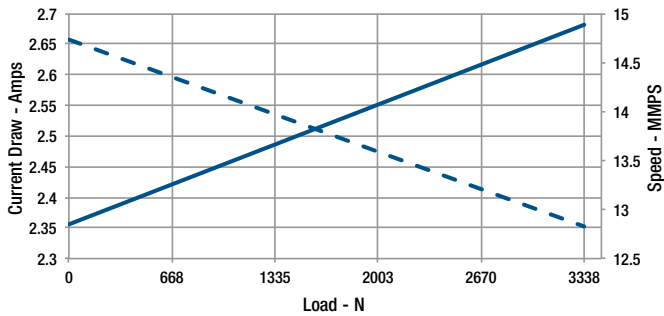

K2G20-230VAc

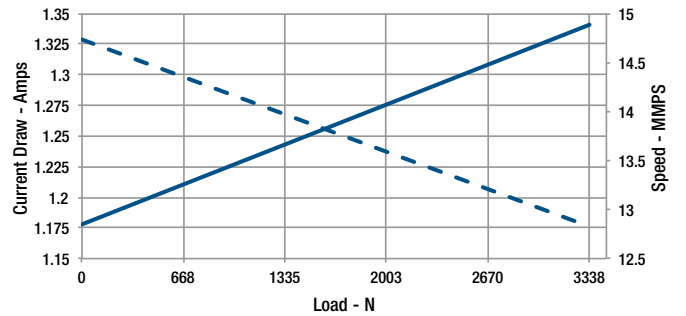

Load Capacity 4895 N

For Imperial Measurements, see page 34.

K2G30-115VAc

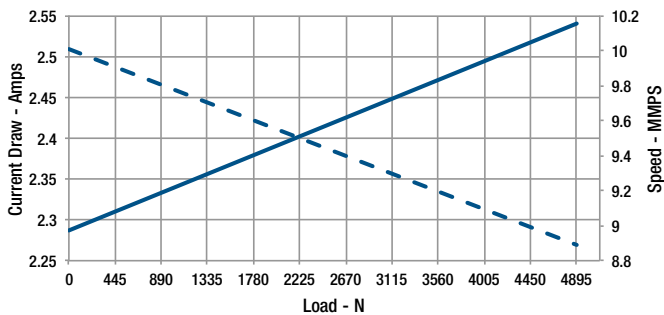

K2G30-230VAc

