

## General Duty In-line Actuator DC Motor Ball Screw



**Up to 200 lbs. (890 N) Rated Load**  
**Up to 1 in. (25 mm)/sec. Travel Speed**

I-Track is a general duty inline actuator suited for applications needing a power-off releasing the rod into a float mode. This unit utilizes a ball screw and planetary drive for long life in a compact space. Models can be fitted with a potentiometer that is directly coupled to the rod that will provide position feedback regardless if the rod is in float or locked mode. It can be driven by PWM to control velocity. For controlling the float and locked rod setting there is a separate input independent of the motor connection. The rod can also be configured to be permanently locked for applications where a floating rod is not required. The unit incorporates a ratchet-free overload slip clutch to protect the drive system.

Specifications	
Operating Voltage	9-15VDC or 22-26VDC
Passed EMI Immunity Testing	ISO 11452-4 Certified
Operating Load	200 lbs. (890 N) Thrust, 800 lbs. (3,559 N) Static
Stroke Length	2, 4, 6, 8, 10 and 12
Duty Cycle	25% max.
No-Load Speed	1.1"/SEC (27.94 mm/sec)
Floating Rod Design	
Operation Temperatures Range	-40° F to 185° F (-40° C to 85° C)
Potentiometer	560-10K Optional
Environment	IP69K Static, IP66 Dynamic

### Features

- **Models available in 12VDC and 24VDC.**
- **Loads up to 200 lbs** thrust.
- **In-line design** reduces base footprint.
- **Releasing clutch** allows rod to float with clutch power-off. Clutch power is separate from motor power.
- **Clutch also acts as over-load protection.**
- **Motor thermal** for added motor protection.
- **Optional Potentiometer** output scaled to stroke.
- **Can be driven by PWM** (not supplied) controller to achieve multiple velocities.
- **Can be mounted at the body** by trunnions (shoulder bolts) or as traditional clevis.
- **Rod end mounts** are configurable.
- **Ball screw and nut** for long life.
- **Operating temperatures** -40° F to +185° F (-40° C to 85° C).
- **Steel rod** for durability.
- **Nitrile impregnated gaskets** for superior sealing.
- **Black powder coat** for 250 hour salt spray protection.
- **Nitrotec® coated steel components** for 250 hour Salt Spray Protection.
- **IP69K Static; IP66 Dynamic.** Rod bellow will allow for temporary operation IP67 submersion.

### Typical Applications

- Throttle controls
- Mobility lifts for vehicles requiring manual operation in emergency situations
- Hydraulic flow controls
- Bus Door Operator
- Hatch lift applications
- Handicap Van Lifts
- Engine Controls
- Emergency Door (lock and unlock via VDC)

## Performance Graphs Imperial & Metric Measurements\*

\*Performance Chart Measurements are Nominal

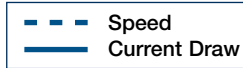

### Imperial Measurements\* I Track Operating Load 200 Lbs.

#### G05-12VDC

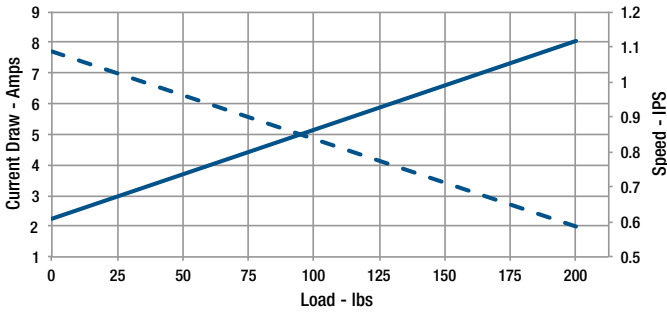

#### G05-24VDC

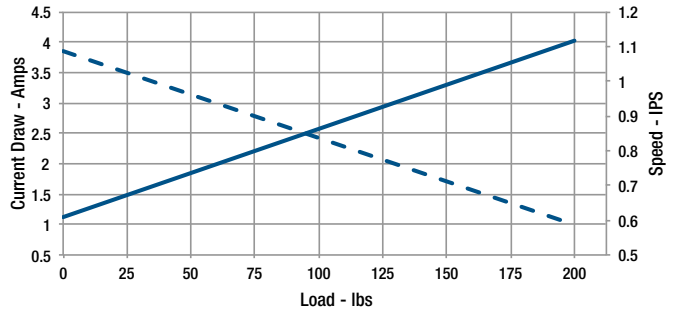

### Metric Measurements\* I Track Operating Load 890 N

#### G05-12VDC

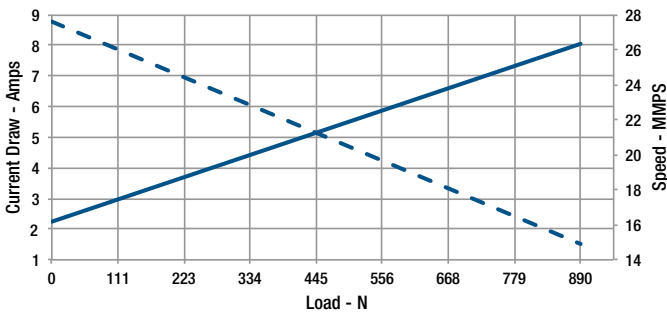

#### G05-24VDC

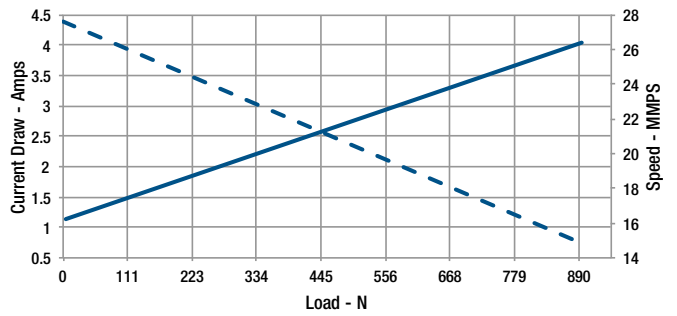

## I-Track Configurator

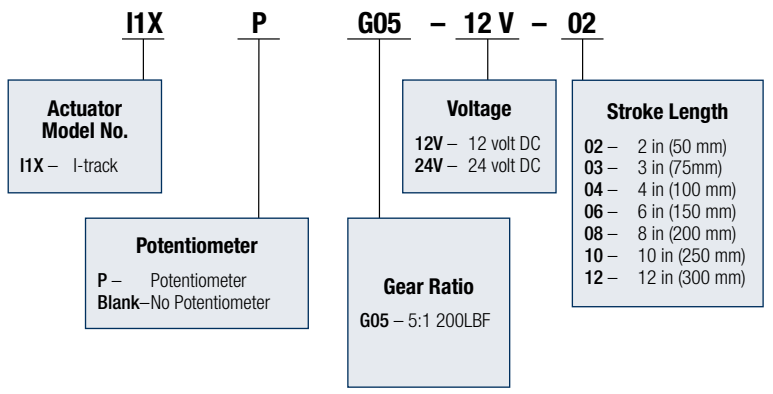

Scan to watch!  
**Linear Actuator Basic Selection Video**  
<https://p.widencdn.net/ydtpk6>

## Dimensions

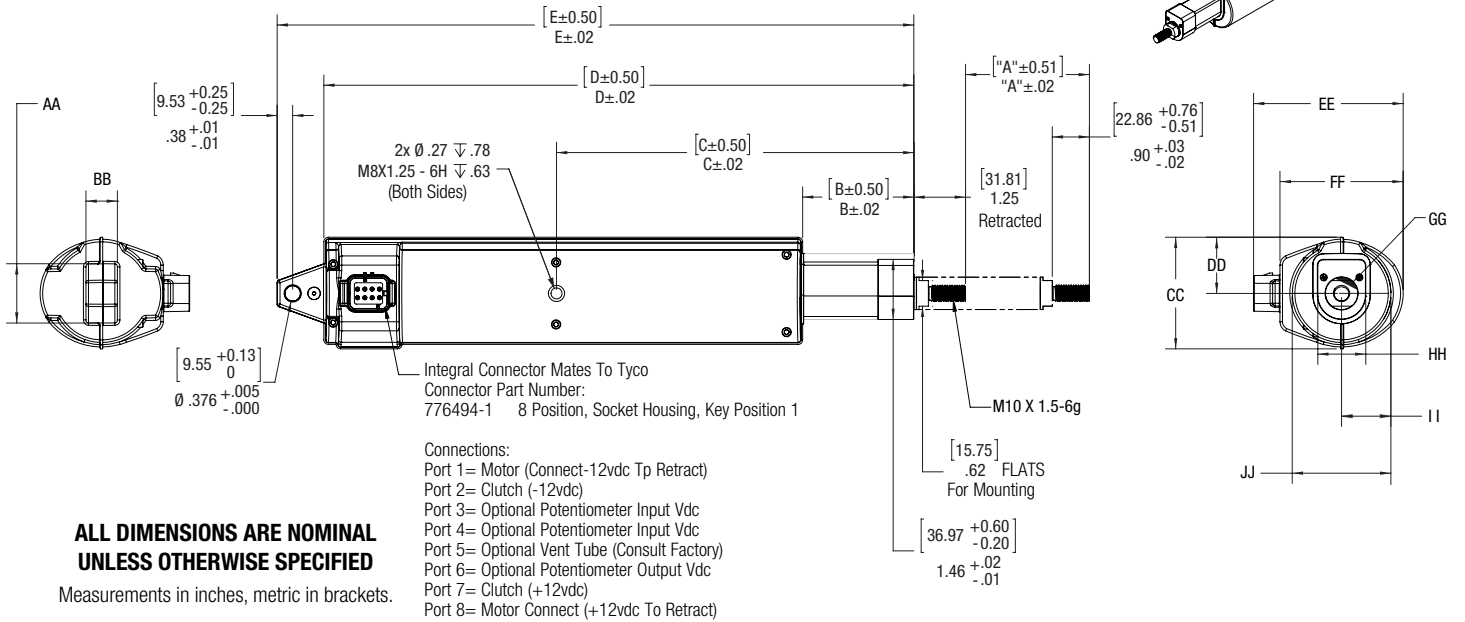
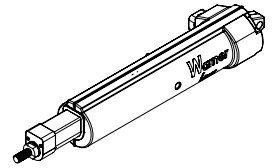

**ALL DIMENSIONS ARE NOMINAL  
UNLESS OTHERWISE SPECIFIED**

Measurements in inches, metric in brackets.

### Dimensions

I-Track	Stroke	in.	mm	in.	mm	in.	mm	in.	mm	in.	mm	in.	mm	in.	mm
		2	50	3	75	4	100	6	150	8	200	10	254	12	300
	A	2.00	50.80	3.00	76.20	4.00	101.60	6.00	152.40	8.00	203.20	10.00	254.00	12.00	304.80
	B	1.69	42.93	2.69	68.33	3.69	93.73	5.69	144.53	7.69	195.33	9.69	246.13	11.69	296.93
	C	7.65	194.31	8.65	219.71	9.65	245.11	11.65	295.91	13.65	346.71	15.65	397.51	17.65	448.31
	D	13.29	337.57	14.29	362.97	15.29	388.37	17.29	439.17	19.29	489.97	21.29	540.77	23.29	591.57
	E	14.42	366.27	15.42	391.67	16.42	417.07	18.42	467.87	20.42	518.67	22.42	569.47	24.42	620.27

**Note:** Special lengths available

### Dimensions (Side Views)

AA	$\begin{bmatrix} 36.49 & +0.50 \\ & -0.20 \\ 1.44 & +0.02 \\ & -0.01 \end{bmatrix}$	DD	$\begin{bmatrix} 34.55 \pm 0.51 \\ 1.36 \pm 0.02 \end{bmatrix}$	HH	$\begin{bmatrix} 29.54 & +0.60 \\ & -0.10 \\ 1.16 & +0.02 \\ & -0.00 \end{bmatrix}$
BB	$\begin{bmatrix} 19.35 & +0.40 \\ & -0.20 \\ .76 & +0.02 \\ & -0.01 \end{bmatrix}$	EE	$\begin{bmatrix} 92.02 & +0.50 \\ & -0.20 \\ 3.62 & +0.02 \\ & -0.01 \end{bmatrix}$	II	$\begin{bmatrix} 30.31 \pm 0.51 \\ 1.16 \pm 0.02 \end{bmatrix}$
CC	$\begin{bmatrix} 68.66 & +0.40 \\ & -0.20 \\ 2.70 & +0.02 \\ & -0.01 \end{bmatrix}$	FF	$\begin{bmatrix} 75.79 & +0.40 \\ & -0.20 \\ 2.98 & +0.02 \\ & -0.01 \end{bmatrix}$	JJ	$\begin{bmatrix} 60.63 & +0.40 \\ & -0.20 \\ 2.39 & +0.02 \\ & -0.01 \end{bmatrix}$
		GG	$\begin{bmatrix} 19.91 \pm 0.25 \\ \emptyset .78 \pm 0.01 \end{bmatrix}$		