

S-Track and Programmable S-Track Features

Acme Screw



Up to 400 lb. (1779 N) Rated Load
Up to 1 in. (25.4 mm)/sec. Travel Speed

New S-Track electric actuators are designed for better control and quieter operation in general duty applications including medical, industrial, turf & garden and recreational vehicles.

S-Track Adjustable Control

The control functions the same as the basic control, but also has the capability to stop at up to four different positions. The stop positions are programmed by using a membrane keypad mounted to the actuator. The main benefit is to be able to change the end limit stop locations and two additional stops if needed.

S-Track Basic Control

The control allows for 12 or 24 VDC switched power operation of the S-Track actuator by turning power off to the motor automatically when the internal end limits are reached.



Specifications

	G07	G11	G14	G17	G26	G35
Load Capacity	125 lbs. (556 N)	175 lbs. (778 N)	200 lbs. (890 N)	225 lbs. (1001 N)	300 lbs. (1334 N)	400 lbs. (1779 N)
Speed at Full Load	1.0 in. (25 mm)/ sec	0.75 in. (18 mm)/ sec	0.62 in. (15 mm)/ sec	0.50 in. (12 mm)/ sec	0.33 in. (8 mm)/ sec	0.25 in. (6 mm)/ sec
Input Voltage	12 or 24 volt DC for all models					
Static Load Capacity	700 lbs. (315 kg) for all models					
Stroke Length	2, 4, 6, 8, 10 and 12 in. (50, 100, 150, 200, 254, 300 mm) for all models					
Duty Cycle	25% for all models					
Operation Temperature Range	-20° F to +150° F (-29° C to + 65° C) for all models, -40° F to +185° F (-40° C to +80° C) Available					
Environment	IP50 Standard, IP65 Dynamic, IP69K Static Configurable					

Features

- **The end limits** are factory set to the maximum allowable stroke of the actuator.
- **The current and temperature** of the motor are monitored at all times and power will be removed from the motor when exceeded to protect components from failure.
- **Several standard input and output features** through the 8-pin molded connector to monitor the operation of the actuator.
- **0-10 VDC position output** follows linearly with the position of the actuator and is offered in many different voltages and currents.
- **End of stroke limit outputs** indicate when the actuator reaches the fully retracted and extended positions.
- **These outputs can be set at the factory** as, active low or active high independently and are good for up to 1 Amp.
- **Live power feature** is available to maintain all of these output signals when switched power is off.
- **IP50 Standard or IP65 Dynamic, IP69K Static** Configurable.
- **Temporary Immersion Boot** available upon request. Consult factory.

Features to Adjustable Control

- **4 adjustable stop positions** using a simple 4 button membrane keypad.
- **Customer can adjust Retract & Extend stops** using membrane keypad. These values will be stored in permanent EEPROM memory for the life of the actuator.
- **Adjusted stop positions can also be erased** at any time to go back to factory default.
- Retract is Stop 1 and Extend is Stop 2. Stop 3 and Stop 4 can be set anywhere inside these two values.
- When Stop 1 (Retract) and Stop 2 (Extend) positions are reached the actuator will automatically stop and not allow movement in that direction. Power will have to be reversed in the opposite direction to move the actuator.
- If Stop 3 and Stop 4 positions are used, when these positions are reached the control will remove power to the actuator until input power is cycled. Then when power is reapplied it can move in either direction.
- **Positional Accuracy**, under no load conditions from the initial stop position setting is within 0.10". This will improve with loaded applications since there will be less coast.
- **Repeatability** of hitting the same stop position every time is within .010".

Typical Applications

- Indoor Office Equipment
- Deck Lifts
- Medical
- Gate Openers

Dimensions & Configurator

Dimensions		in.	mm	in.	mm	in.	mm	in.	mm	in.	mm
S-TRACK	Stroke	4	102	6	152	8	203	10	254	12	305
	A	9.32	236.7	11.32	287.5	13.32	338.3	15.32	389.1	17.32	439.9

Note: Special lengths available

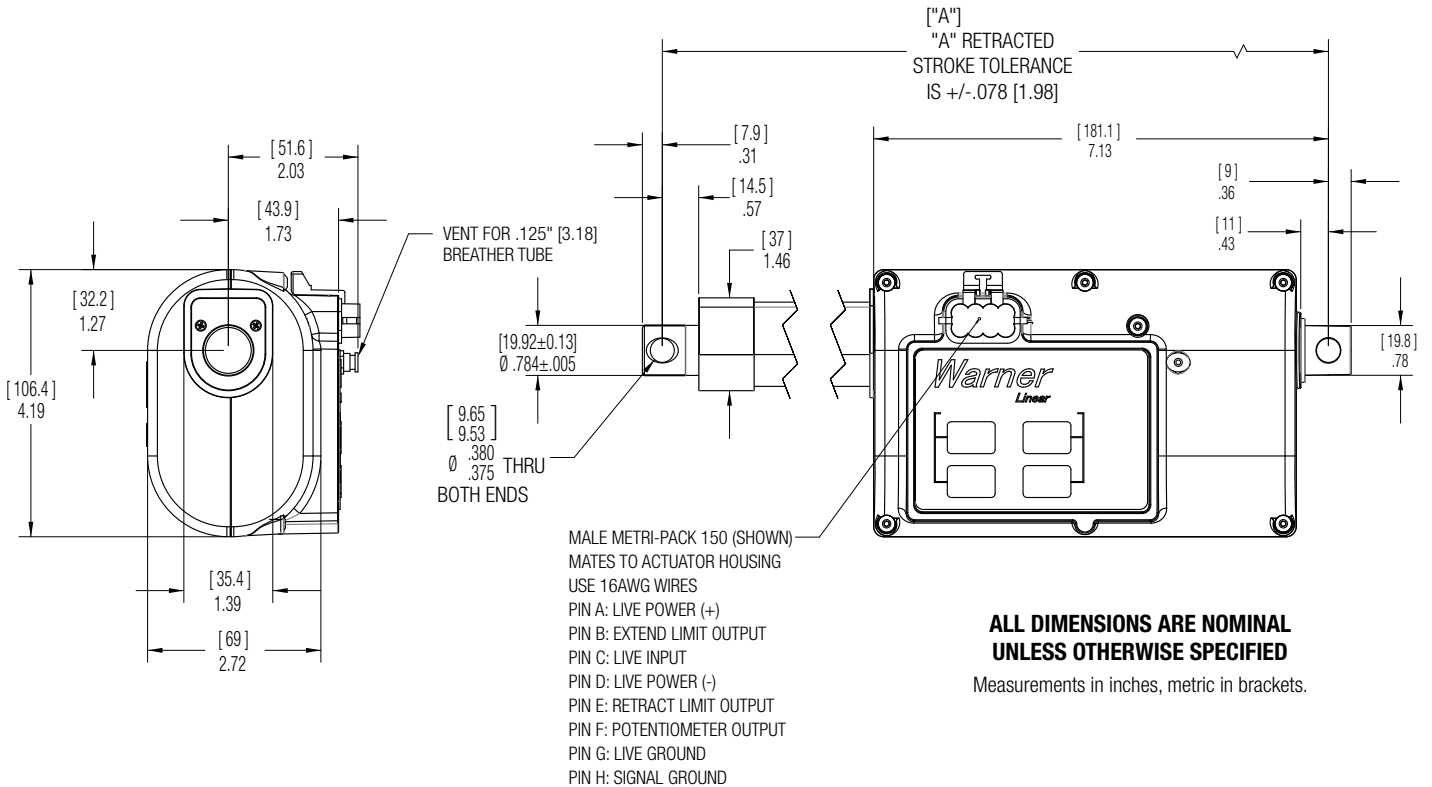

S-Track Configurator

S1 P1 G11 - 12 V - DN - 08 - 1

Dimensions

Stroke	"A"
2" (50 mm)	9.32
4" (100 mm)	9.32
6" (150 mm)	11.32
8" (200 mm)	13.32
10" (254 mm)	15.32
12" (300 mm)	17.32

Actuator Model No.

S1 - Aluminum Housing
S2 - Plastic Housing

Voltage

12 - 12 VDC
24 - 24 VDC

Stroke Length

02 - 02 in. (50 mm)
04 - 04 in. (100 mm)
06 - 06 in. (150 mm)
08 - 08 in. (200 mm)
10 - 10 in. (250 mm)
12 - 12 in. (300 mm)

IP-Rating

Blank - IP 50
1 - IP 65/IP69K

Output/Limit Switch

P0 - Basic Control, No Outputs
P1 - S-Track Basic Control, POT output and Limit Switches
K1 - Key Pad Control

Gear Ratio

Model	Stroke	Ratio	Mounting
G07	1"	44	.375 - 8 screw
G11	.75"	44	.375 - 12 screw
G14	.62"	44	.375 - 16 screw
G17	.50"	18	.375 - 8 screw
G26	.33"	18	.375 - 12 screw
G35	.25"	18	.375 - 16 screw

End Fitting

Blank - STD
R90 - 90



Scan to watch!
Linear Actuator Basic Selection Video
<https://p.widencdn.net/ycltpk6>

For Protective Boot
Consult factory for ordering details.

Wiring Diagram & Performance Graphs Imperial* Measurements

Wiring Diagram for Basic and Adjustable Control

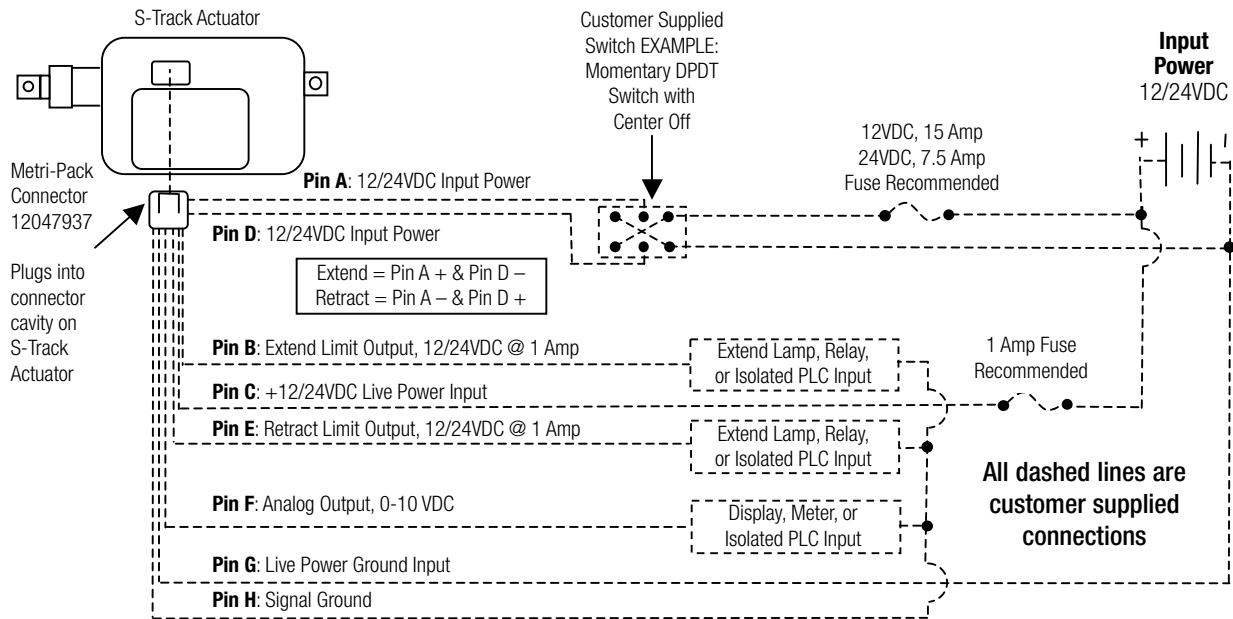

Performance Graphs Imperial Measurements*

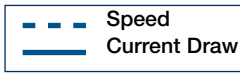

*Performance Chart Measurements are Nominal

Load Capacity 125 lbs.

For Metric Measurements, see pages 17-18.

S Track G07-12VDC

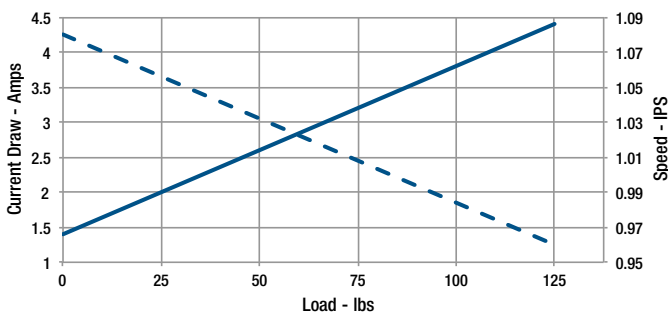

S Track G07-24VDC

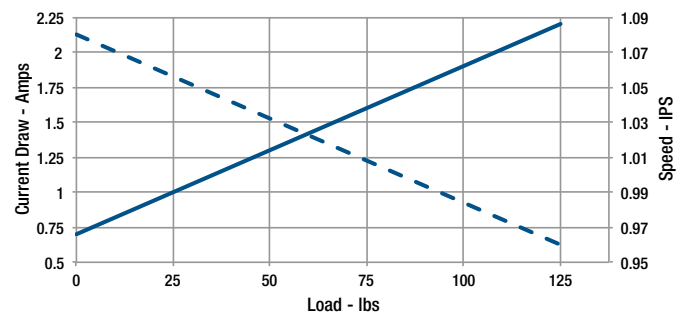

Load Capacity 175 lbs.

For Metric Measurements, see pages 17-18.

S Track G11-12VDC

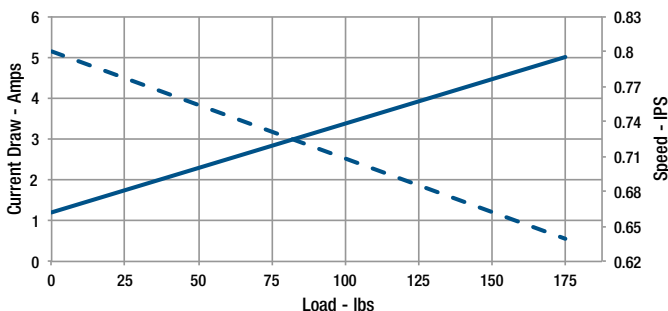

S Track G11-24VDC

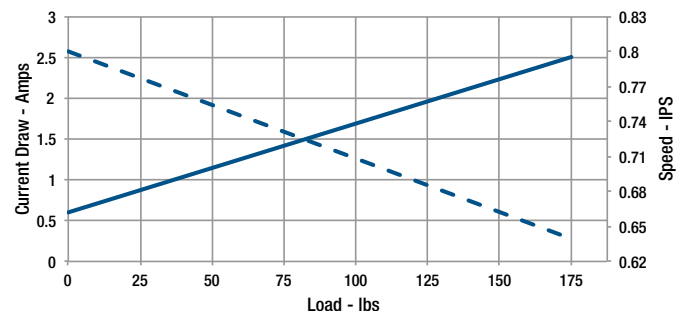

S-Track

Performance Graphs Imperial Measurements*

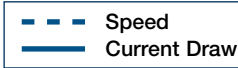

*Performance Chart Measurements are Nominal

Load Capacity 225 lbs.

For Metric Measurements, see pages 17-18.

S Track G14-12VDC

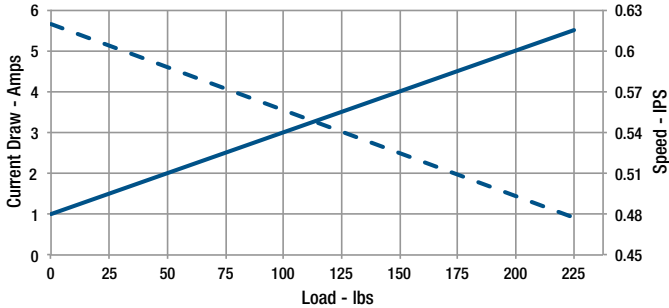

S Track G14-24VDC

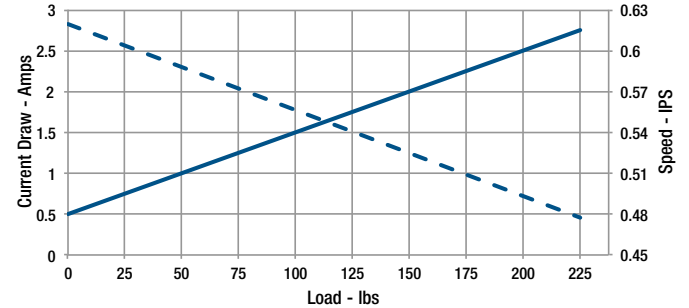

Load Capacity 250 lbs.

For Metric Measurements, see pages 17-18.

S Track G17-12VDC

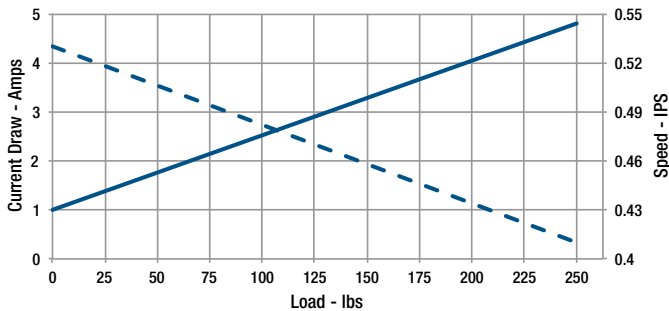

S Track G17-24VDC

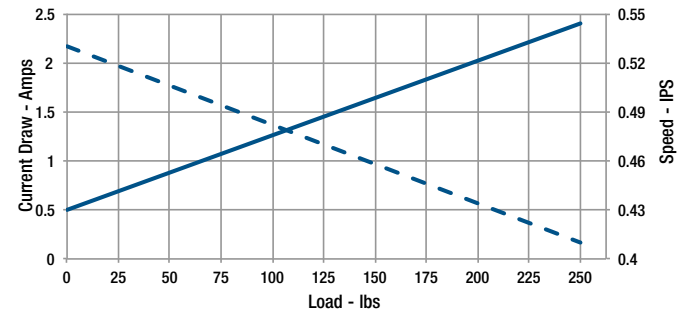

Load Capacity 300 lbs.

For Metric Measurements, see pages 17-18.

S Track G26-12VDC

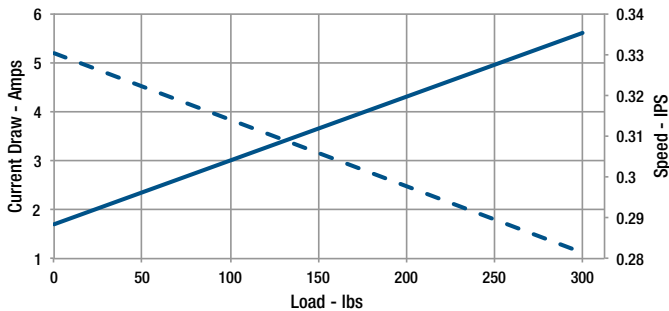

S Track G26-24VDC

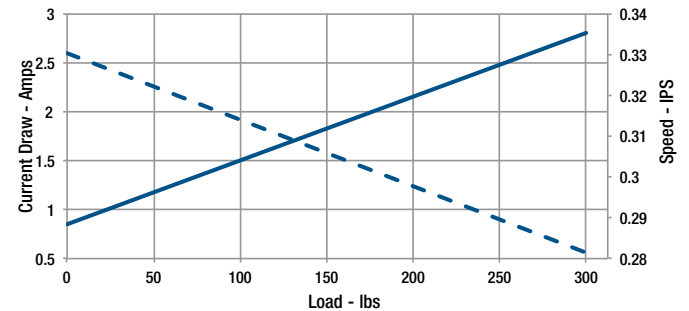

Load Capacity 400 lbs.

For Metric Measurements, see pages 17-18.

S Track G35-12VDC

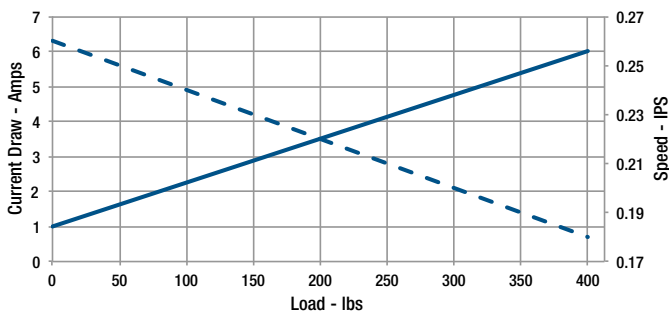

S Track G35-24VDC

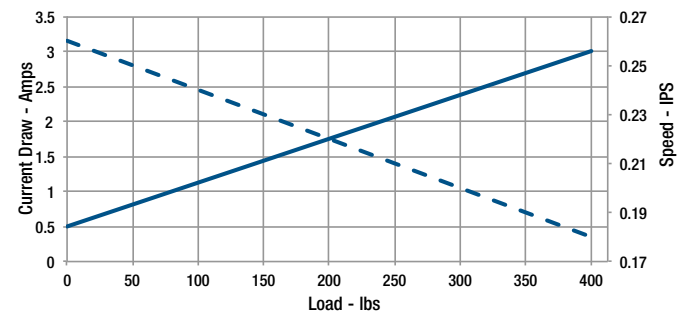

Performance Graphs Metric Measurements*

*Performance Chart Measurements are Nominal

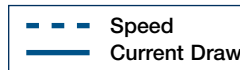

Load Capacity 556 N

For Imperial Measurements, see pages 15-16.

S Track G07-12VDC

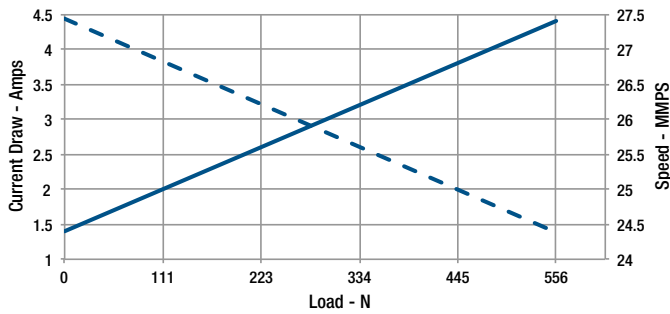

S Track G07-24VDC

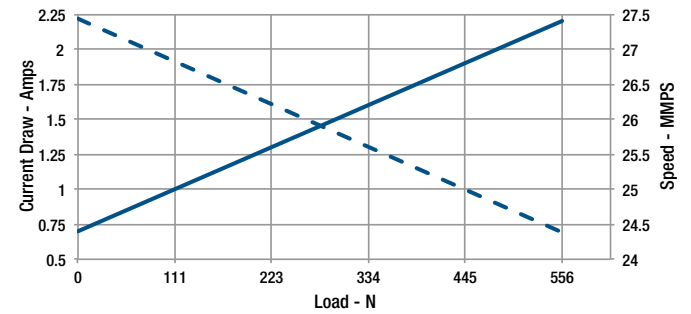

Load Capacity 779 N

For Imperial Measurements, see pages 15-16.

S Track G11-12VDC

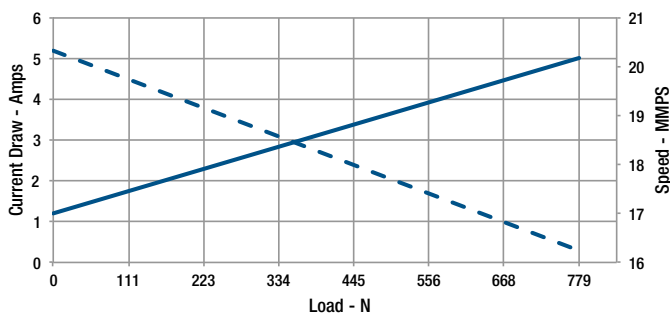

S Track G11-24VDC

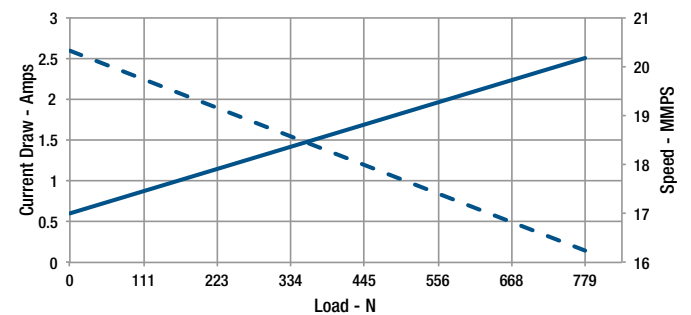

Load Capacity 1001 N

For Imperial Measurements, see pages 15-16.

S Track G14-12VDC

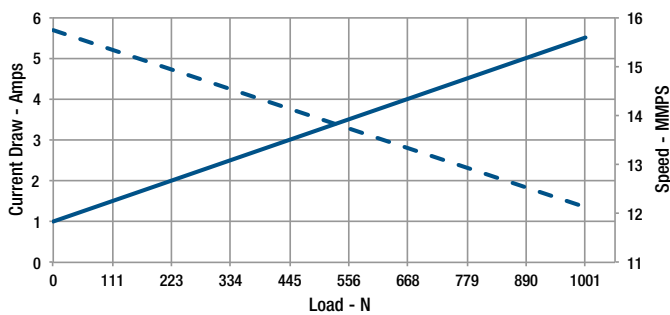

S Track G14-24VDC

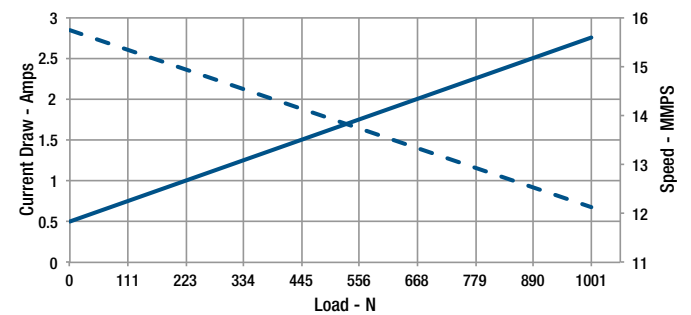

S-Track

Performance Graphs Metric Measurements*

*Performance Chart Measurements are Nominal

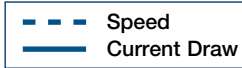

Load Capacity 1113 N

For Imperial Measurements, see pages 15-16.

S Track G17-12VDC

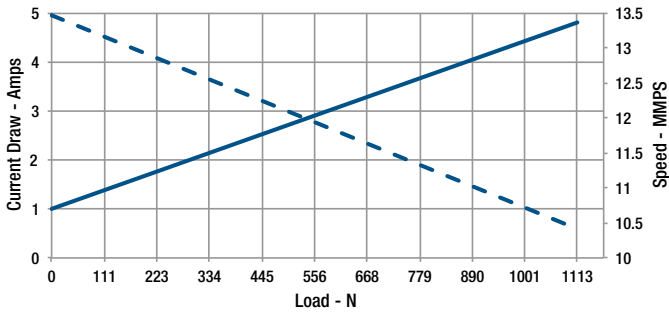

S Track G17-24VDC

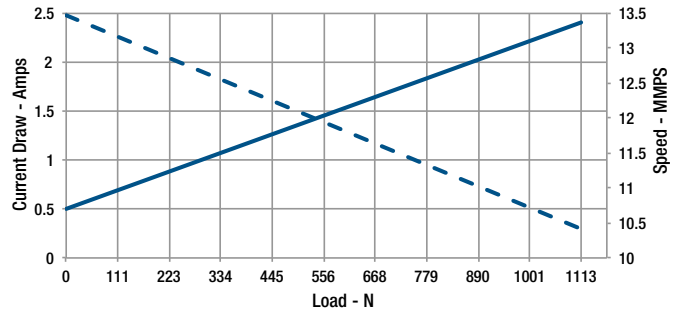

Load Capacity 1335 N

For Imperial Measurements, see pages 15-16.

S Track G26-12VDC

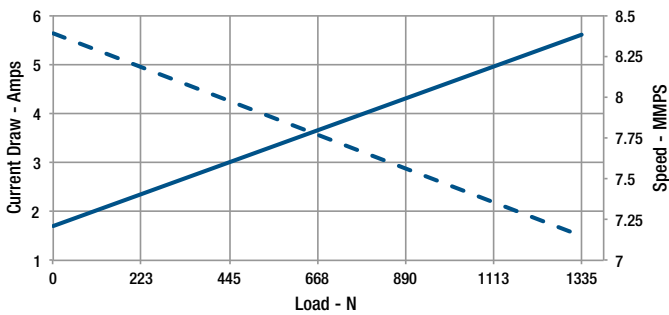

S Track G26-24VDC

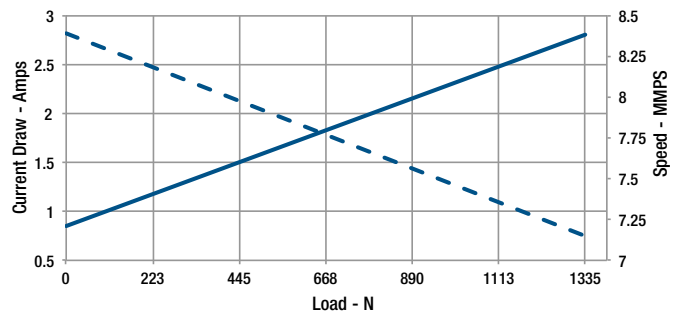

Load Capacity 1780 N

For Imperial Measurements, see pages 15-16.

S Track G35-12VDC

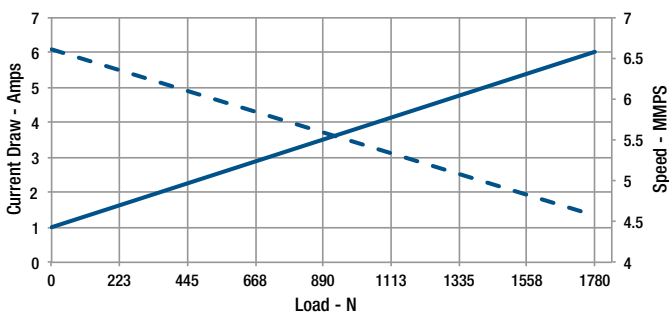

S Track G35-24VDC

