

# Mesur-Fil® Fluid Couplings

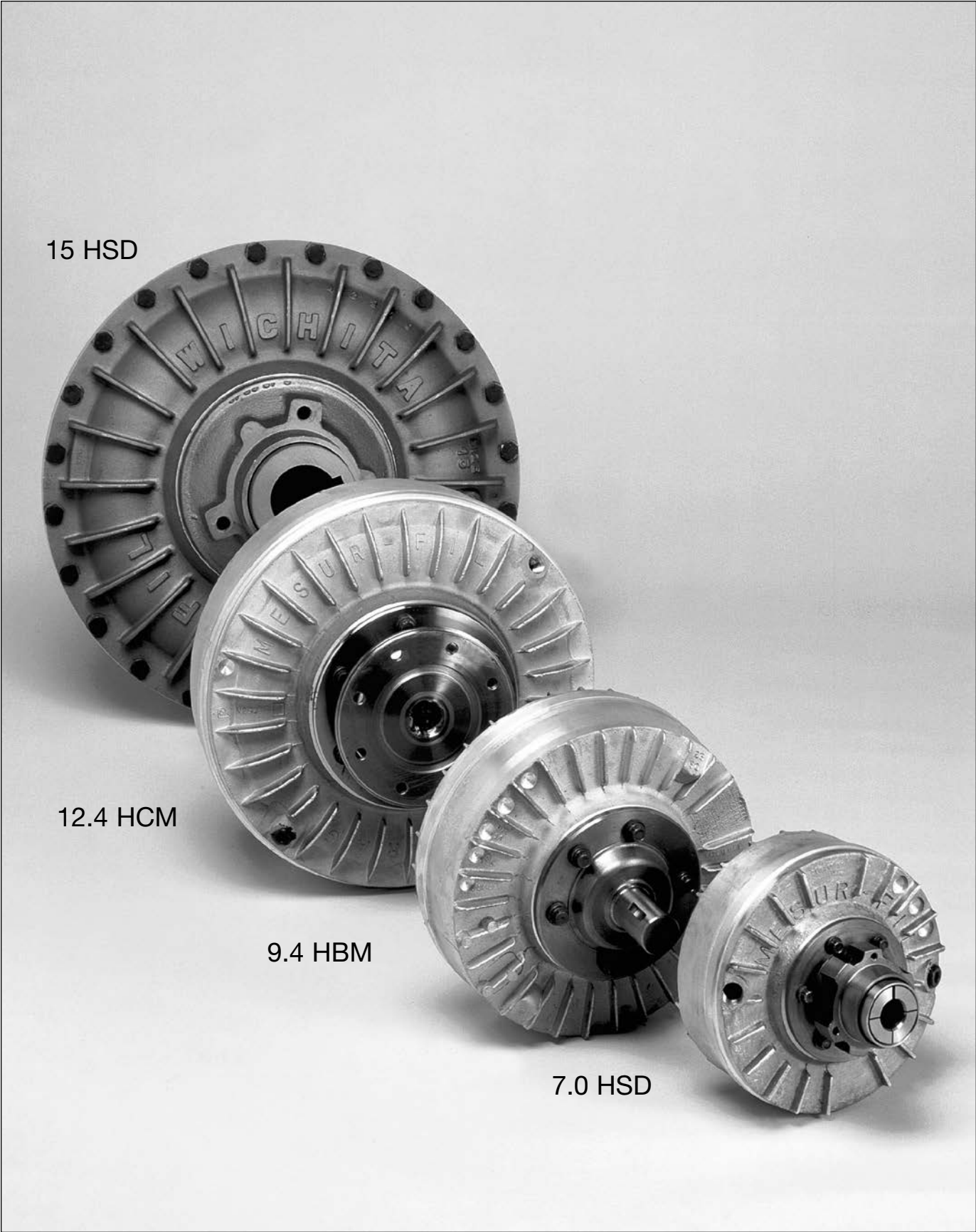

## Wichita Mesur-Fil® Fluid Couplings

deliver reliable smooth power transmission. To consistently deliver, we select only from the highest quality materials. Our manufacturing and product assembly are completed under the most exacting guidelines and established procedures. The result is unquestioned consistent product dependability.

Mesur-Fil Fluid Couplings are rated for motors up to 2,500 HP. They have earned a reputation for providing smooth, soft starts while reducing current draw on the motor by 33%.

**Mesur-Fil Fluid Couplings** are ideally suited for direct drive applications between electric motors and gear boxes.

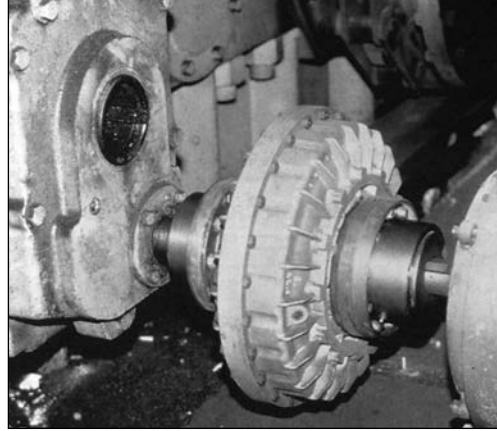

## Typical Applications

### Bulk Material Handling Equipment and Mining Related Industries:

- Conveyors of all types
- Crushers
- Excavators
- Fans
- Mills
- Mixers
- Pumps
- Screening Plants

### Petrochem and Chemical Processing:

- Agitators
- Blowers/Fans
- Centrifuges
- Compressors
- Mixers
- Pumps

### Other Applications include:

- Amusement park rides
- Construction
- Machine tools
- Oil Field
- Power Generation
- Ski resort chair lifts



**Mesur-Fil 7.0 HSD** allows shock-free acceleration on large inertia loads.

Picture Courtesy of Torpey Denver, Inc.



**Mesur-Fil 7.0 HSD** on amusement park ride, "Speed Boats," giving cushioned, smooth starts.

Picture Courtesy of Torpey Denver, Inc.

# Mesur-Fil® Fluid Couplings

## Design Advantages

Mesur-Fil Fluid Couplings allow motors to start unloaded and to reach operating speed with smooth, controlled acceleration. This makes it ideal for applications with high inertia loads. They are available in either constant or delay fill versions.

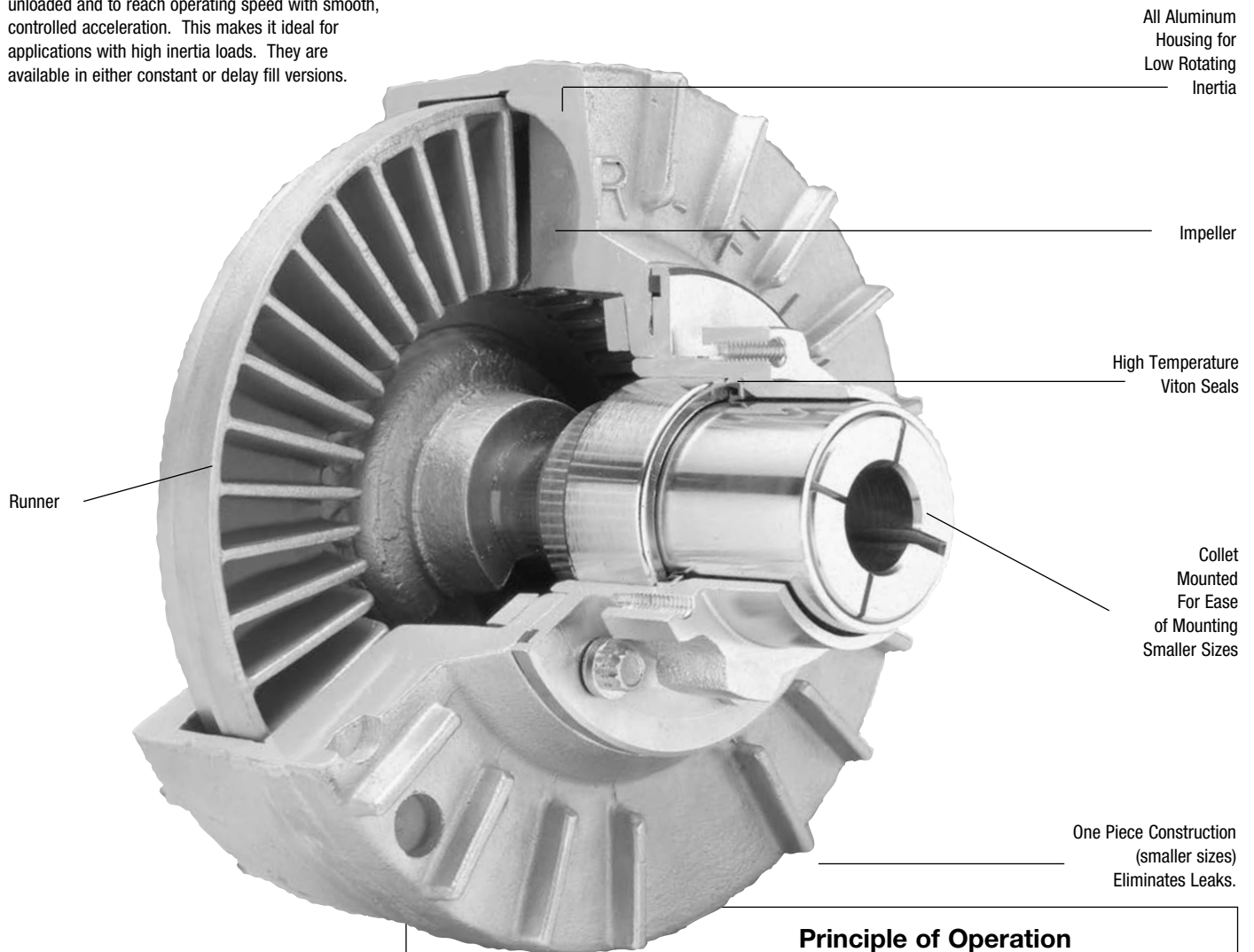

### Benefits

Mesur-Fil Fluid Couplings offer several advantages:

- Reduced energy consumption
- Jam/overload protection
- Shock load cushioning
- No metal-to-metal contact
- Wide range of available mounting options
- High temperature Viton seals
- Available from over 700 Formsprag Authorized Distributors.

### Principle of Operation

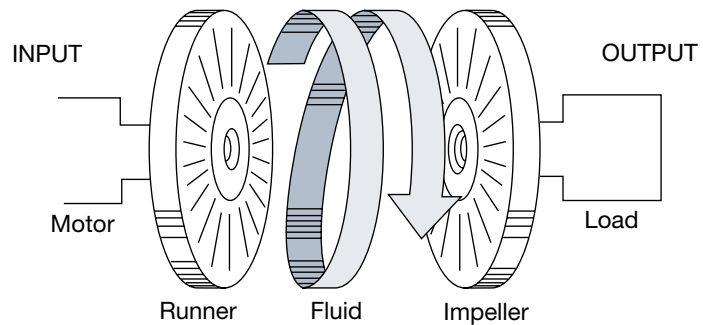

There are three primary components to Mesur-Fil Fluid Couplings:

1. Vaned runner
2. Vaned impeller
3. Fluid fill

Torque, produced by the prime mover (motor) acting on a vaned runner, is transmitted through the flow of fluid into

the chambers formed by the two coupling halves. The oil (fluid) is subsequently thrown into the vaned impeller connected to the load causing it to turn. It is important to note, that as this transmission of power takes place, there is virtually no wear on the transmitting parts because there is no mechanical contact between them.

## Fluid Requirements

Figure 2 reveals a typical NEMA B electric motor torque curve together with the particular operating characteristics of a specific coupling with a designated fill level. With no power supplied, all of the fluid is settled at the bottom of the coupling. Slip rate in this condition is 100% with the input free to turn. With the motor starting and increasing in speed to the breakdown point, torque builds in the coupling. As torque increases, the coupling begins to deliver the load to the motor, eventually bringing the load up to speed (refer to the load acceleration area in Figure 2).

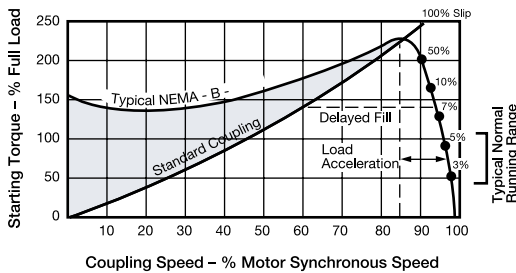

Figure 2 - Starting Torque

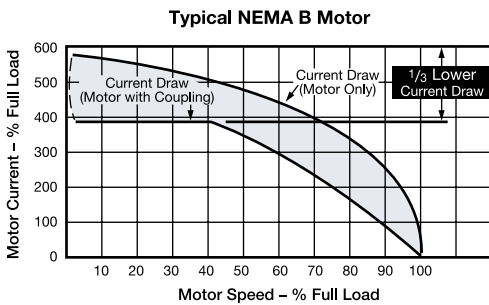

Figure 3 - Start-up Burnout Protection

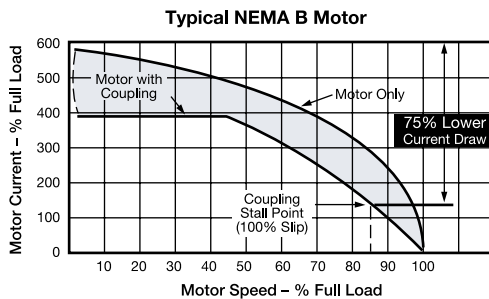

Figure 4 - Jam Load Burnout Protection

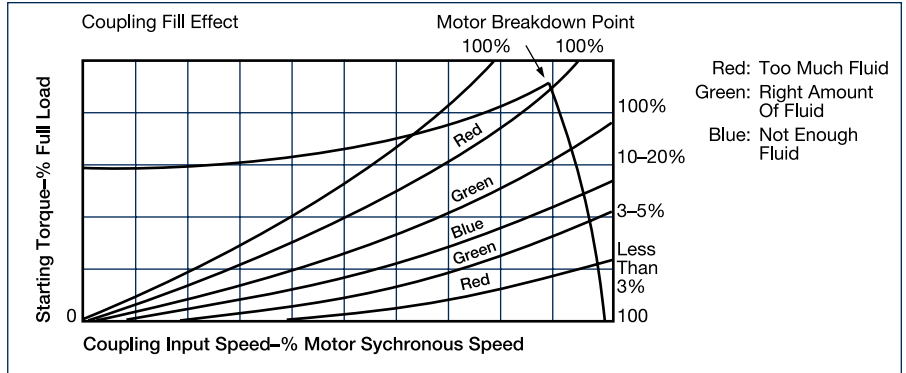

Figure 1 - Motor Breakdown Points

The area on the chart between the motor torque curve and the 100% slip curve represents the excess torque available to the motor to start itself without also having to start the load. It is this operating characteristic which permits a soft start with a one-third lower current draw on the motor (see Figure 3). (It should be noted that because the coupling torque can only be developed if the runner is turning at a slower speed than the impeller, an ideal small amount of slip of 3% to 5% is necessary).

The Mesur-Fil Fluid Coupling provides for jam load protection to the motor and other vital power system components. It is designed to allow the motor to decelerate only to its breakdown point (see Figure 4). The results without the fluid coupling could be a locked rotor condition, resulting in excessive current draw and potential motor damage. Additionally, the coupling distributes the shock of an overload over a longer time span, thus reducing the possibility of damage.

## Delayed Fill

Mesur-Fil Fluid Couplings, sizes 15 through 34 (30 to 1500 HP), have an available delayed fill option restricting starting torque to 140% of full load while still ensuring low slip at full speed. The result is a softer, more gradual start which can be advantageous for applications such as belt conveyors and mixers.

The operating principles are simple. With the idle coupling (see Figure 5) the purpose of the delayed fill chamber is to isolate a portion of the fluid from the main coupling. As the runner accelerates (see Figure 6), the chamber attached to the runner gradually releases fluid into the main coupling through specially calibrated orifices. The fill increases proportionally with the output speed. With acceleration complete (see Figure 7) at the high speed running position, almost all of the fluid has been released from the chamber into the coupling, giving the coupling high fill/low slip characteristics.

Figure 5 Standstill

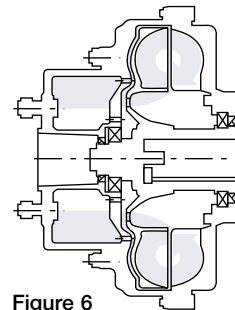

Figure 6 Accelerating

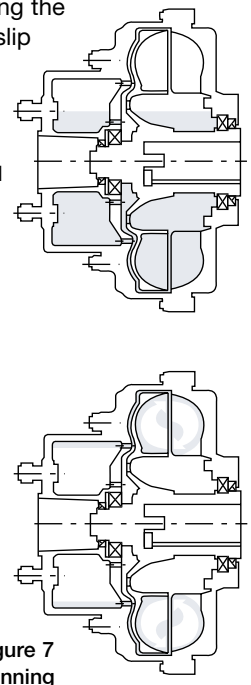

Figure 7 Running

# Mesur-Fil® Fluid Couplings

## Mounting Types per Size

Mounting Type	Size											Mounting Application	
	7.0*	9.4*	12.4*	15	17	19	21	24	27	29	34		
<b>HC</b> (page 168)	•	•	•										Basic coupling for custom input & output
<b>HCM</b> (pages 170-171)	•	•	•	•	•	•	•	•	•	•	•	•	For use with flexible gear couplings
<b>HBM</b> (page 169)	•	•	•										Shaft to shaft applications For stub shaft input/output sizes 7-12.4
<b>HSD</b> (pages 172-173)	•	•	•	•	•	•	•	•					Parallel, QD sheave application

\* Modular design (See page 167)

**HC Sizes 7.0-12.4 Input and Output customer supplied.**  
(page 168)

This is a basic coupling with an input bore for direct mounting on the motor shaft end and a convenient bolt circle for customer-designed output configurations.

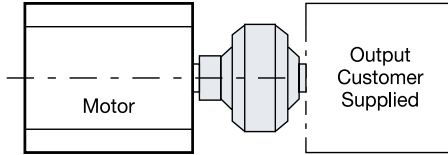

**HCM**  
(pages 170-171)

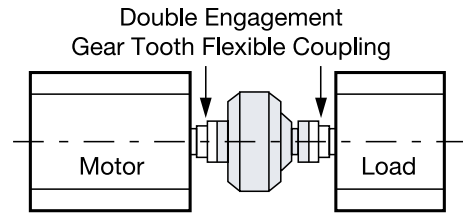

The Model HCM Fluid Coupling is a complete unit with both input and output flanges. It is intended for installation between two halves of a double engagement gear tooth flexible coupling which is customer supplied. This arrangement provides for a wide range of input and output configurations for ease of installation.

**HBM Sizes 7-12.4**  
(page 169)

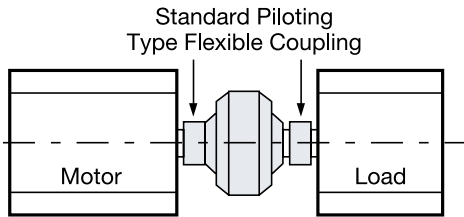

This coupling is a complete unit with straight input and output shaft. It is installed between two piloting type flexible couplings supplied by the customer.

**HSD**  
(pages 172-173)

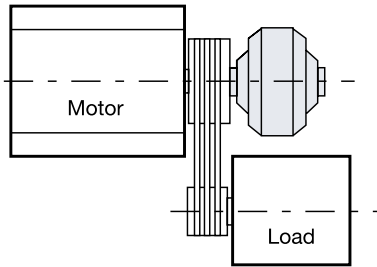

Hydro-sheave couplings are mounted to the motor shaft end and provide minimal overhung loads for parallel (belt-driven) shaft applications. The smaller sizes (7-12.4) are installed very quickly and easily utilizing a slotted collet in which no drilling or tapping is required. The slotted collet is finished bored to fit standard NEMA B motor shaft dimensions. The larger sizes (15-24) are installed with a center locating bolt that does require drilling and tapping to ensure proper mounting.

The Model HSD Fluid Coupling consists of a basic fluid coupling, input and output group, and a standard customer supplied QD type sheave. The sheave is mounted on a coupling that has been installed on the end of a driveshaft.

# Mesur-Fil® Fluid Couplings

## Selection and Sizing

### Fill Levels (NEMA B Motors)

The Quick Selection Chart (see Figure 8) provides the correct size coupling and fill level for any standard NEMA B motor within the Mesur-Fil range. It also provides the slip rate that can be anticipated at normal operating speed. Having the correct amount of oil in the coupling is extremely critical to ensure safe and proper operation. Figure 9 shows the effects of either too much or too little fluid. With an optimum amount of fluid, the breakdown point of the motor with the 100% slip line of the coupling provide the best combination of soft start with slip rate at normal speed. With too much fluid (red area), the slip rate is lower and the start is harder. With too little fluid (blue area), the start will be softer but the slip rate will be much higher. This can cause heat dissipation problems, and, in extreme situations, the coupling may completely fail to move the load.

A choice of fluids is also available. In a normal environment, petroleum oil is the best fluid to use. For hazardous conditions such as those encountering dust, paint spray, etc., a special fire-resistant fluid may be required.

### Delay chamber is recommended for the following applications:

- Overland conveyors
- Blowers/Fans
- Mixers
- Crushers
- Excavators
- Mills
- Large inertia drives
- Centrifuges

Figure 8 Quick Selection Chart

HP	1200 RPM			1800 RPM			HP	KW
	Cplg. Size	Fill No.	% Slip	Cplg. Size	Fill No.	% Slip		
1/2	7.0	12	6	7.0	8	3	1/2	0.38
3/4	9.4	8	3	7.0	8	4	3/4	0.56
1	9.4	8	3	7.0	9	4	1	0.75
1 1/2	9.4	8-1/2	3	7.0	11	5	1-1/2	1.1
2	9.4	9	4	7.0*	12	6	2	1.5
3	9.4	10	5	9.4	8	2	3	2.2
5	12.4	7	3	9.4	8-1/2	3	5	3.8
7 1/2	12.4	8	2-1/2	9.4	9	3	7-1/2	5.6
10	12.4	9	4	9.4	10	4-1/2	10	7.5
15	12.4	11	5	12.4	7	3	15	11.3
20	15	2	3-1/2	12.4	8	2-1/2	20	15.0
25	15	2	5	12.4	8-1/2	3	25	18.8
30	15	1	4 1/2	12.4	9	3-1/2	30	22.5
40	15	0	5 1/2	12.4	10	4	40	30.0
50	17	1-1/2	4	12.4	11	5	50	37.5
60	17	1	4	15*	3	3	60	45.0
75	19	2	4-1/2	15	2	3-1/2	75	56.3
100	21	1/2	3-1/2	15	0	3-3/4	100	75
125	21	1-1/2	4-1/2	17	2	3	125	94
150	24	2	2-1/2	17+	2	4	150	113
200	24	2	3-1/2	19+*	2	3-1/2	200	135
250	24	1	4	19+* or 21*	0 or 2	3-1/2 or 2	250	188
300	27	1		21+*	2	3	300	225
350	27	0		21+*	1	3	350	263
400	29	1		24	3		400	300
450	29	1		24	2		450	338
500	29	1		24	2		500	375
600	29	0		27	2		600	450
700	29	0		27	1		700	525
800	29	0		27	0		800	600
900	34	1						
1,000	34	1						
1,250	34	0						
1,500	34	0						

Figure 9 Coupling Fill Effect

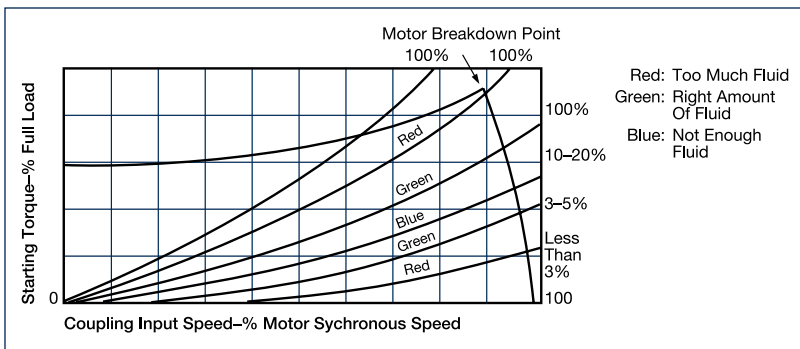

\* In these applications, coupling will develop stall torque somewhat higher than motor breakdown torque.

+ In these applications, frequent starts or overloads may overheat coupling. Use only for loads at or below rated torque of motor with infrequent starts.

• **Caution!** 7% or higher slips may cause overheating if coupling is cycled too rapidly.

For minimum operating temperature below -10° F, consult the factory.

**Note:** For vertical mounting order unit with both the standard and optional fill plugs on both sides of the unit.

## Input speed vs. Horsepower Graph

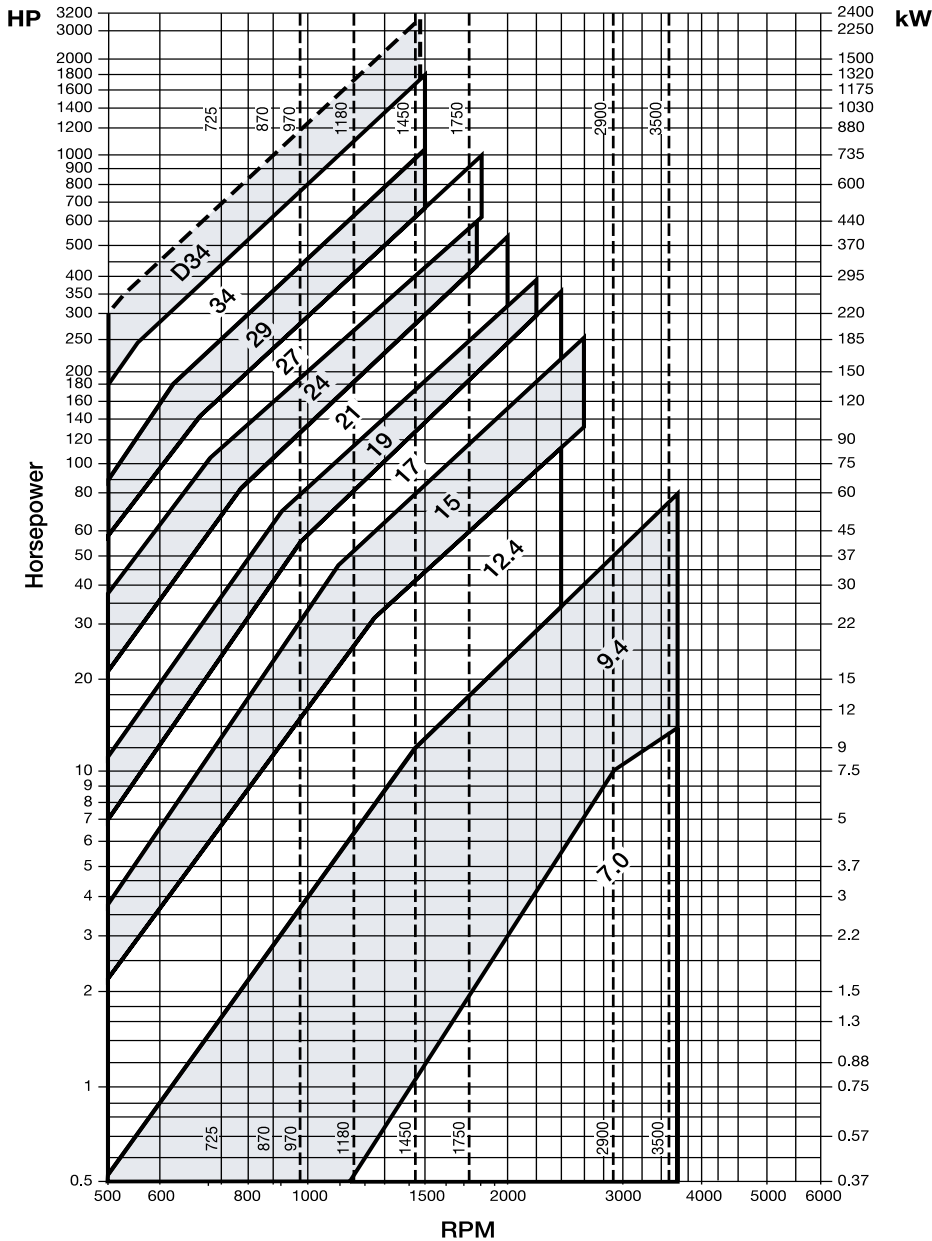

## Fluid quantities (fluid ozs.)

Fluid Quantities (U.S. Fluid Ounces)						
Fill Number						
Size	7	8	9	10	11	12
7.0		18.5	21	23	25.5	27.6
9.4		43	49	54	60	65
12.4	87	100	112	125	138	150

Fluid Quantities (U.S. Quarts)					
Fill Number					
Size	0	1	2	3	4
15	8	7.6	7.0	6.3	5.7
17	12.4	11.5	10.6	9.6	8.7
19	15	14	13	11.8	10.6
21	20	18.8	17.3	15.8	14.3
24	30	28	26	23.9	21.7
27	47	43.3	40.2	36.5	32.8
29	52	48.4	44.7	40.7	36.5
34	87.2	81	74.6	70	66

Delayed Fill			
Size	2	3	4
15	9.1	8.1	6.8
17	14.4	13.5	12.4
19	17.2	16.1	14.8
21	24.3	22.5	20.4
24	33	30.2	27.5
27	52.8	49.1	45.4
29	66.6	62.3	57
34	91.1	84.5	78.6

## Fluid Recommendation

**OIL: SAE 10W (Spec. MIL-L-2104 B)**  
 Chevron: Hydraulic Oil EP 32    Shell: Tellus 32  
 Esso: Nuto H 32    Texaco: Rando HD 32  
 Mobil: DTE 24    Total: Azolla ZS 32

## FIRE RESISTANT FLUID

Fyrquel: 220

## Overload Protection

### Fusible plug

In overload conditions, as the slip increases and the oil temperature rises, seals become damaged and begin to leak. In order to avoid this damage, in critical applications, it is advisable to install a fusible plug instead of a solid plug. Overload protection. For sizes 7.0 to 12.4 a 250° F fusible plug is available only as an option. For sizes 15 to 34 a 290° F fusible plug is standard. (A 250° F or 350° F fusible plug is available as an option.)

### Fusible pin For sizes 15–34

It's possible to avoid loss of oil from the unit by fitting a fusible pin. When temperature increases, reaching melting point of fusible element, a pin is released and touches a cam mounted on a relay which gives an alarm or switches off the electric motor. Like the fusible plug there are three different fusible elements. This solution needs only the replacing of the fusible element or fusible pin.

### Electronic overload controller (Torque limiter) For sizes 15–34

This device measures the speed of the coupling, stopping the motor or giving a signal when the preselected limit is exceeded. With this device nothing has to be replaced, and after having eliminated the cause of the overload, the transmission can run normally.



# Mesur-Fil® Fluid Couplings

## Slip Curves

### Size 7.0

Maximum speed 3,600 RPM (All configurations)

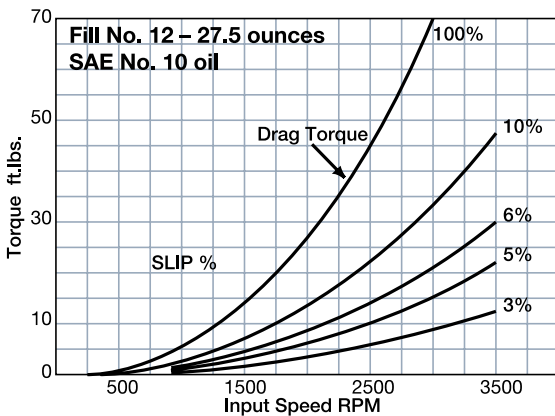
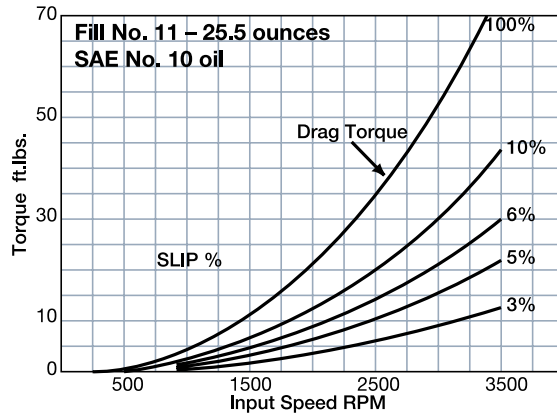
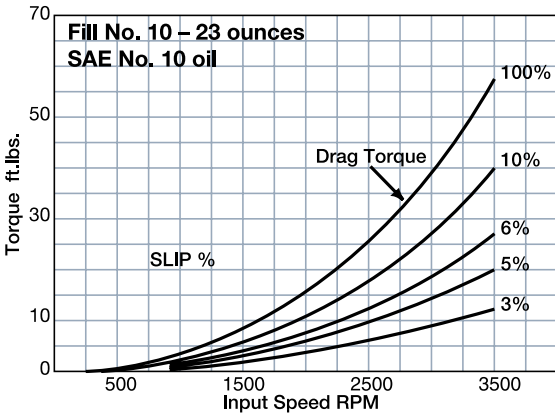
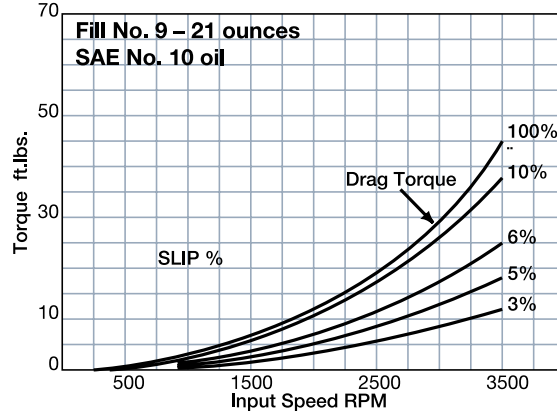
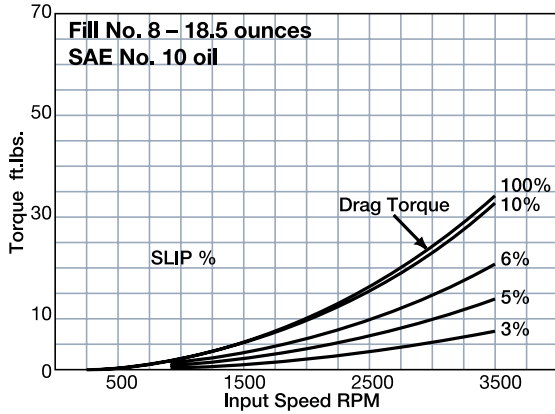

# Mesur-Fil® Fluid Couplings

## Slip Curves

Size 9.4

Maximum speed 3,600 RPM Except HSD-Max. 2,600 RPM

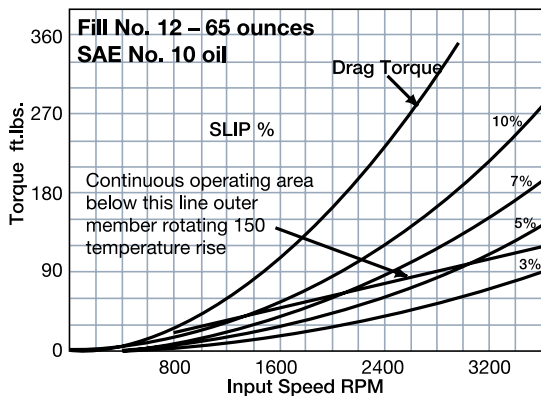
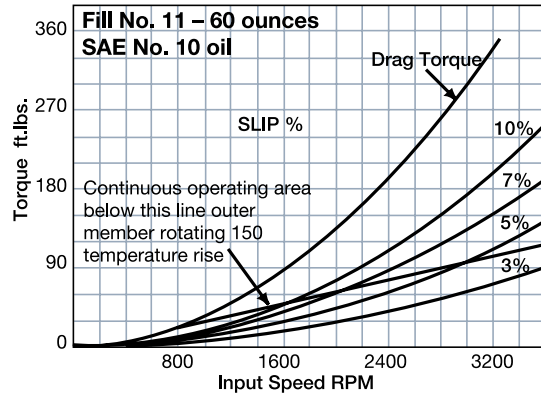
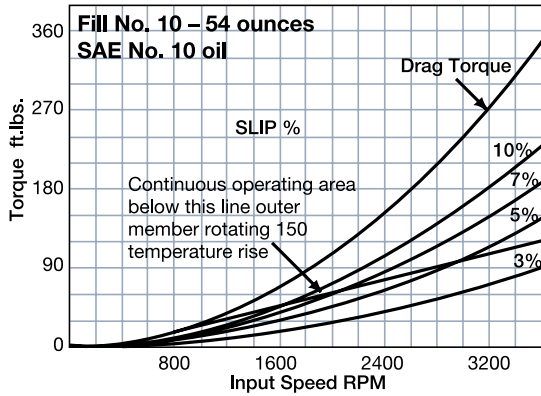
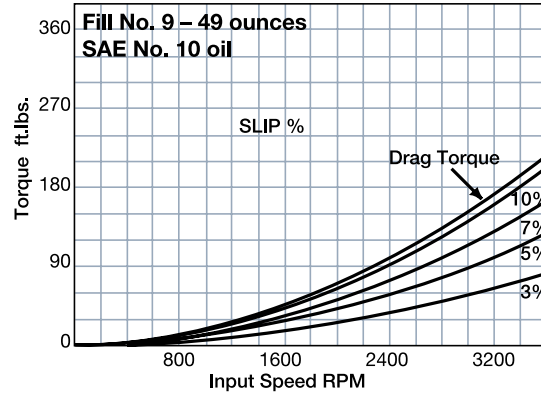
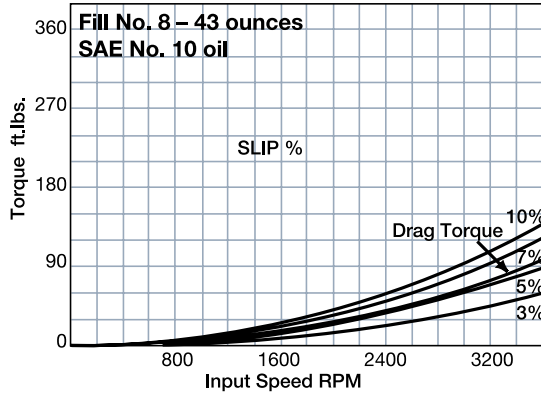

G

# Mesur-Fil® Fluid Couplings

## Slip Curves

### Size 12.4

Maximum speed 2,400 RPM Except HSD-Max. 1,800 RPM

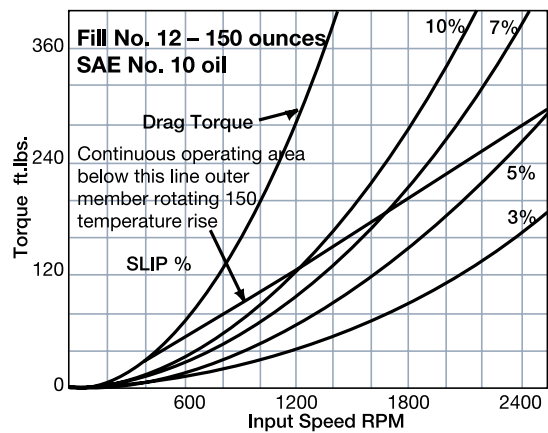
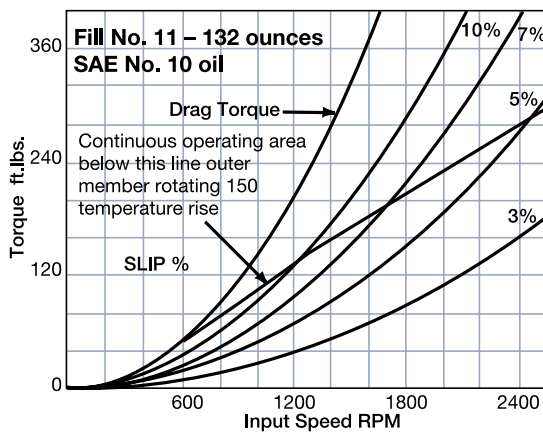
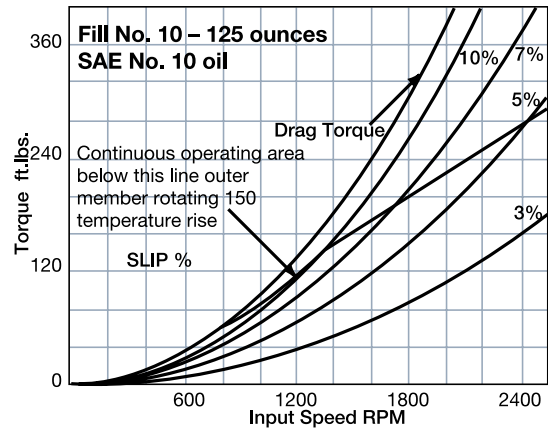
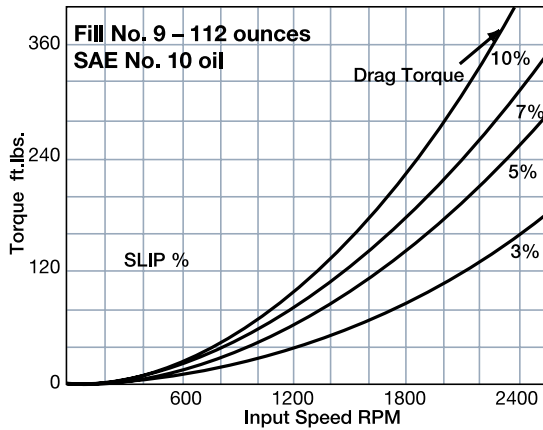
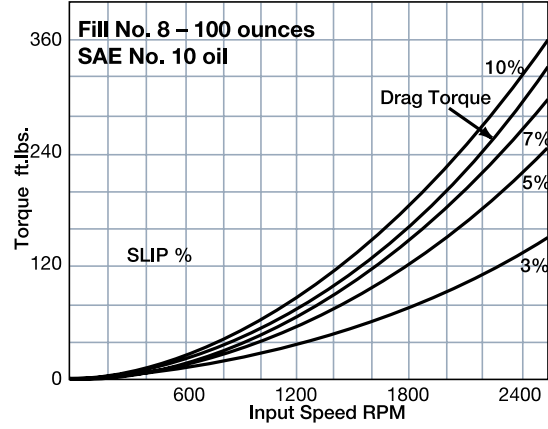
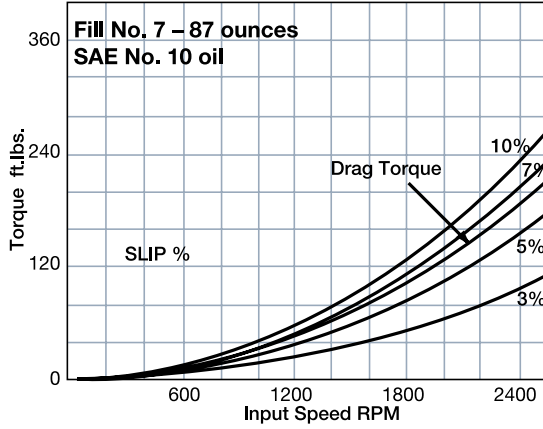

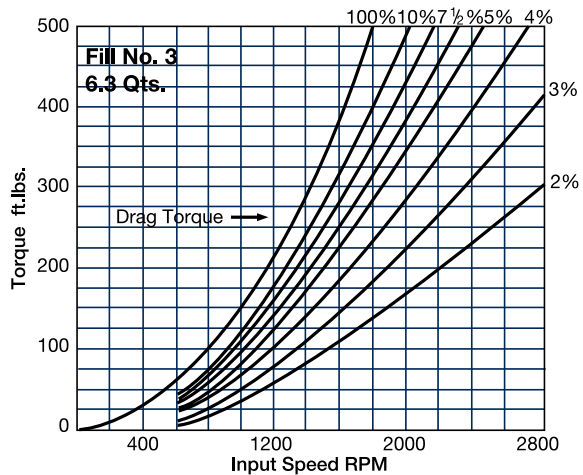
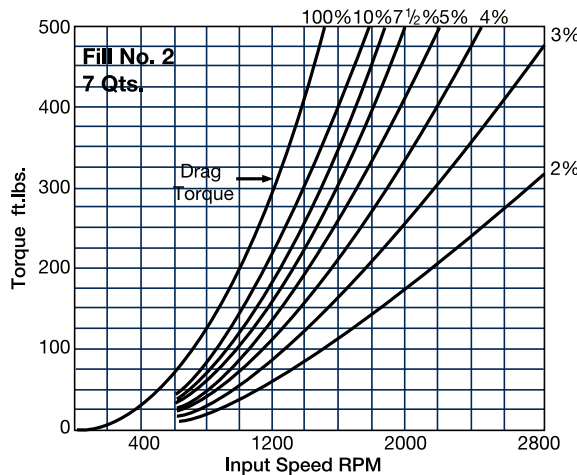
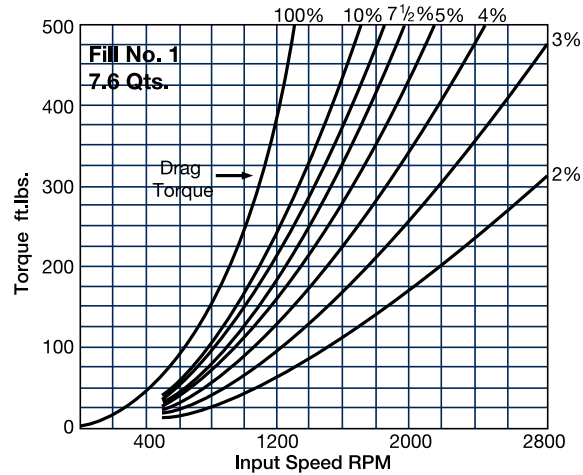
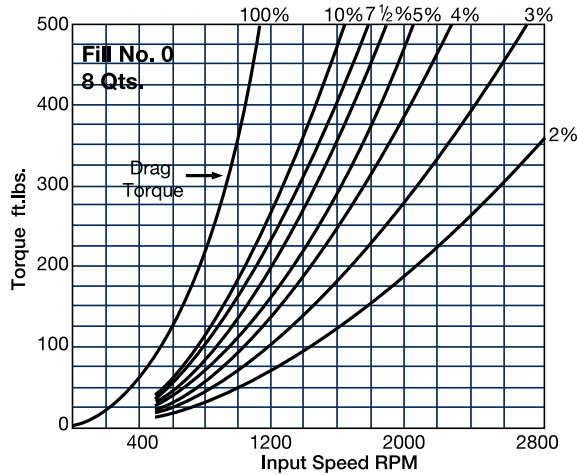

### Selection Example:

7.5 HP at 1,750 RPM

Normal running torque =

$$\frac{7.5 \text{ HP} \times 5,250}{1,750} = 22.5 \text{ lb.ft.}$$

Pullout torque is obtained at approximately 85% full motor speed and for NEMA B motors, this is approximately 200% normal rated torque.

If the pullout torque is unknown, then assume 200% of normal rating occurring at a speed of 1,540 RPM, with full motor speed of 1,750 RPM.

Pullout torque = 2 \* 22.5 lb.ft. = 45 lb.ft.

Locate the pullout torque against RPM curve to insure the point is slightly above the drag torque line.

Locate the normal torque against RPM curve to insure the point is below the 7% slip line. Ideally, plot the point between 3% and 5% slip line.

# Mesur-Fil® Fluid Couplings

## Modular Design Concept

Sizes 7.0, 9.4, 12.4

### Configuration

#### HCF

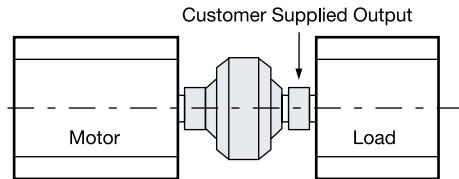

Consists of Model HC and input group. The input group is finish bored to fit standard NEMA B motor shafts. The optional output groups available (HCM, HBM) are shown on this page or the HCF output group must be supplied by the customer. Consult engineering for details.

#### HCM

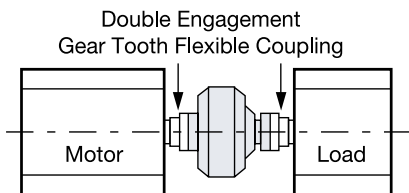

The Model HCM Fluid Coupling is a complete unit with both input and output flanges. It is intended for installation between two halves of a double engagement gear tooth flexible coupling which is customer supplied.

#### HBM

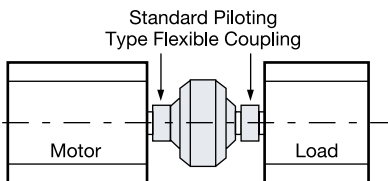

This coupling is a complete unit with a straight input and output shaft. It is installed between two piloting type flexible couplings supplied by the customer.

#### HSD

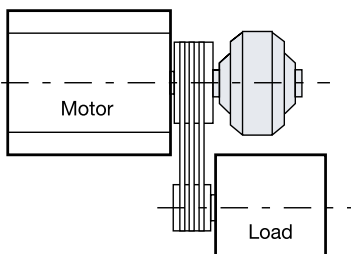

The Model HSD Fluid Coupling consists of a basic fluid coupling, input and output group, and a standard customer supplied QD type sheave. Hydro-sheave couplings provide minimal overhung loads for parallel (belt-driven) applications. The sheave is mounted on a coupling installed on the end of a driveshaft.

Mesur-Fil Couplings can be installed very quickly and easily utilizing a slotted collet for mounting on the motor shaft instead of the center bolt that is most commonly used with other sheave drives. Unlike the center bolt, the slotted collet requires no drilling and tapping of the end of the motor shaft. The slotted collet is finished bored to fit standard NEMA B motor shaft dimensions. Available bore sizes are found elsewhere in this brochure.

# Mesur-Fil® Fluid Couplings

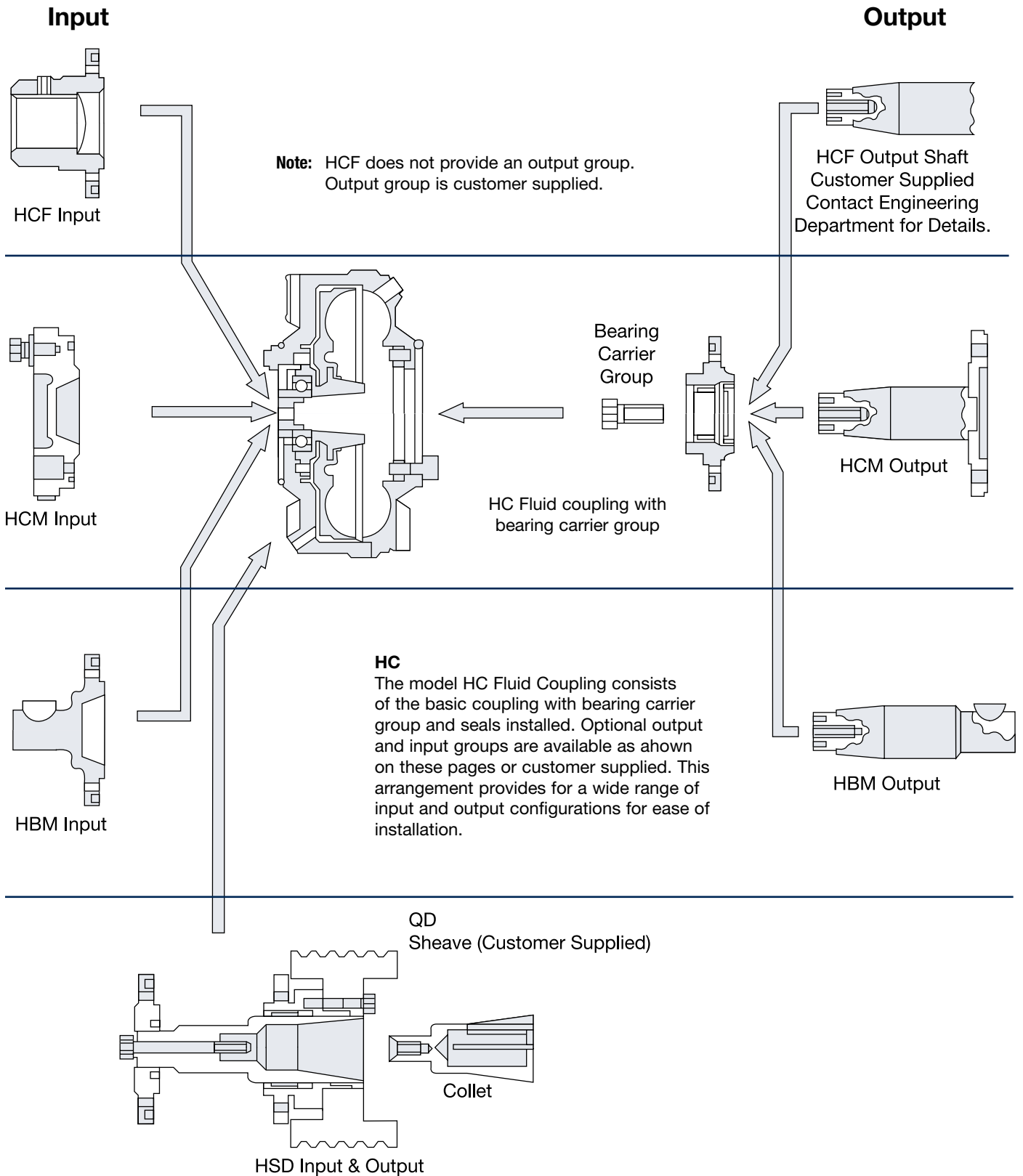

G

# Mesur-Fil® Fluid Couplings

## Model HC (Custom Applications)

Sizes 7.0 – 12.4

Size	Assembly Number
7.0	6-607-001-002-0000
9.4	6-609-001-001-0000
12.4	6-612-001-002-0000
3/8" NPT Fusible Plug	4-619-068-000-0

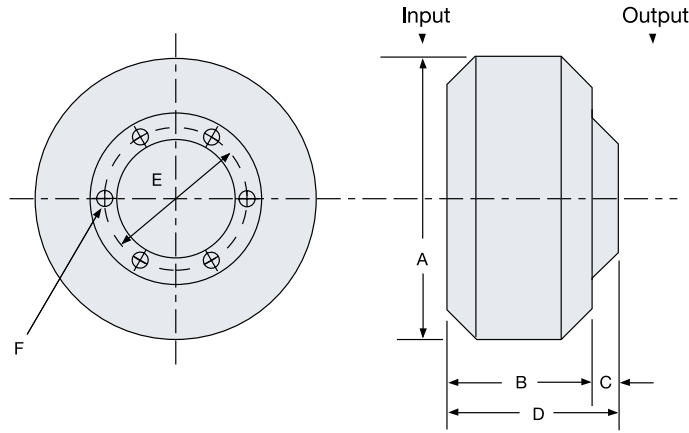

### Dimensions: inches

Size	A	B	C	D	E	F	Wt. Lb. Less Oil	Oil US Oz. Max.
7.0	7.81	3.67	.56	4.23	3.188	17/64	10.1	27.6
9.4	10.25	4.70	.77	5.47	4.250	25/64	20.5	65
12.4	13.50	5.98	.82	6.80	5.650	25/64	38.0	150

### Output Shaft

(Detail drawing)

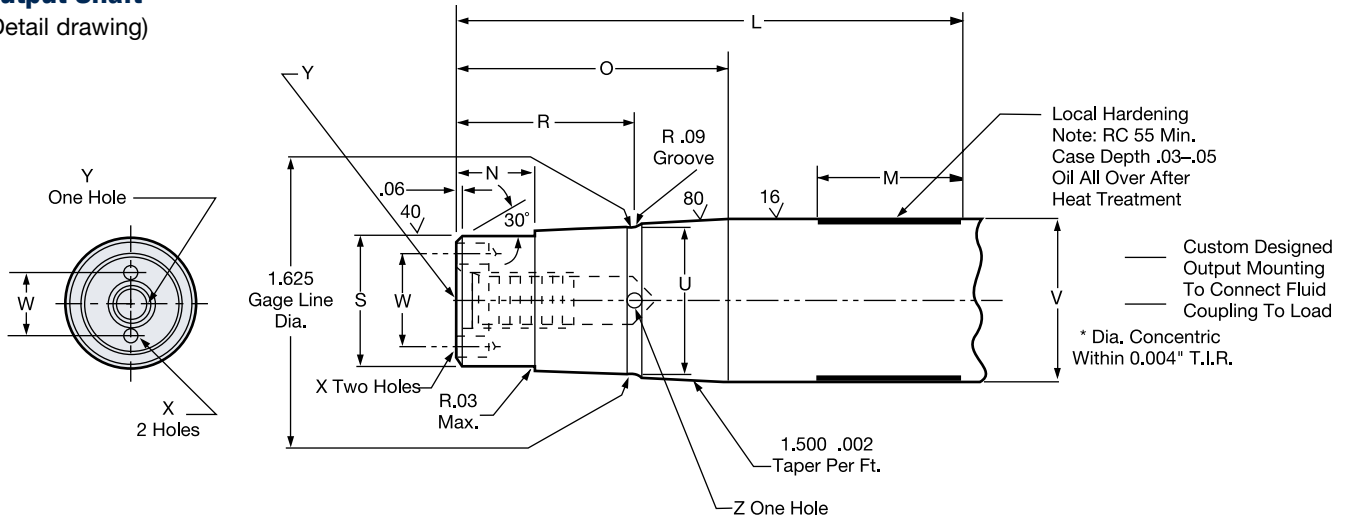

### Dimensions: inches

Size	L	M	N	O	R	S	U	V	W	X	Y	Z
7.0	4.17	1.50	1.270	1.91	.60	.9845	1.124	1.250	.750	9/64	1.10	.60
						.9839	1.116	1.249		x .26		
9.4	5.42	1.50	1.905	2.90	.83	1.3782	1.577	1.850	1.062	13/64	.96	.80
						1.3776	1.589	1.749		x .50		
12.4	6.75	1.80	2.05	3.156	.90	1.5746	1.785	2.000	1.125	13/64	.96	.90
						1.5750	1.777	1.994		x .50		

# Mesur-Fil® Fluid Couplings

## Model HBM (Shaft-to-Shaft Applications)

Sizes 7.0 – 12.4

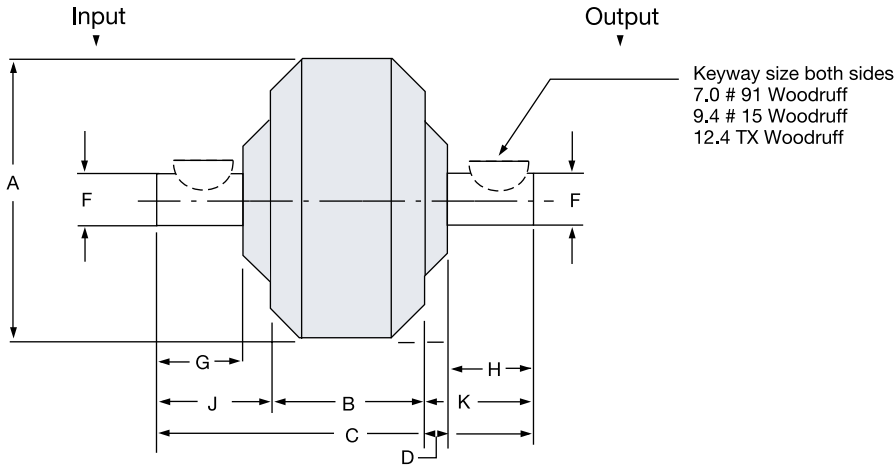

Size	Assembly Number
7.0	6-607-004-000-0000
9.4	6-609-004-000-0000
12.4	6-612-004-000-0000
3/8" NPT Fusible Plug	4-619-068-000-0

### Dimensions: inches

Size	A	B	C	D	F	G	H	J	K	Wt. lb. Less Oil	Max. oz.
7.0	7.81	3.67	8.25	.56 .999	1.000	1.62	1.62	2.34	2.24	12.65	27.6
9.4	10.25	4.70	10.89	.77 1.249	1.250	2.06	2.12	3.10	3.09	27.70	65
12.4	13.50	5.98	13.67	.82 1.624	1.625	2.12	2.75	3.88	3.88	51.07	150

Single Flexing Coupling	
7.0	AJ15*
9.4	AJ30*
12.4	AJ30*

\* Refers to TB Wood's Form-Flex couplings



# Mesur-Fil® Fluid Couplings

## Model HCM (Flexible Gear Couplings with Shrouded Bolts)

Sizes 7.0 – 12.4

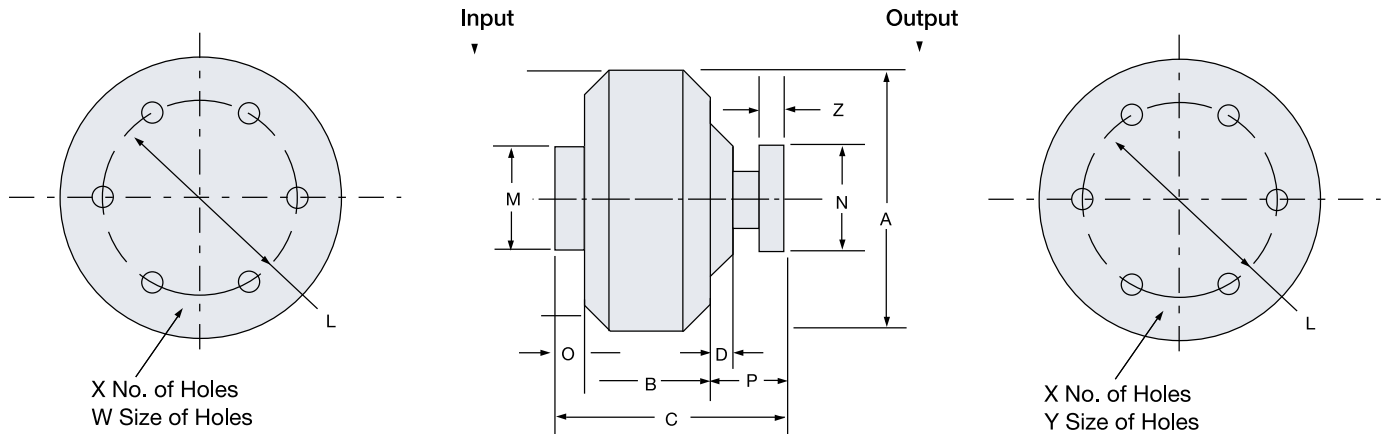

Size	Assembly Number
7.0	6-607-003-000-0000
9.4	6-609-003-000-0000
12.4	6-612-003-000-0000
3/8" NPT Fusible Plug	4-619-068-000-0

### Dimensions: inches

Size	A	B	C	D	L	M	N	O	P	W	X	Y	Z	Wt. lb. Less Oil	Oil Max. oz.	WR <sup>2</sup> lb.ft. <sup>2</sup>		Gear Coupling Size
																Outer	Inner	
7.0	7.81	3.67	5.98	.56	3.75	4.70	4.56	1.10	1.21	1/4-20 .56 Deep	6	.254 .256	3/16	16.10	27.6	.42	.10	1
9.4	10.25	4.70	7.49	.77	4.812	5.90	6.00	1.14	1.65	3/8-16 .65 Deep	8	.380 .382	1/4	32.25	65	1.27	.51	1-1/2
12.4	13.50	5.98	8.67	.82	4.812	6.85	6.00	1.14	1.55	3/8-16 .74 Deep	8	.380 .382	1/4	53.25	150	4.12	1.33	1-1/2

### HCM

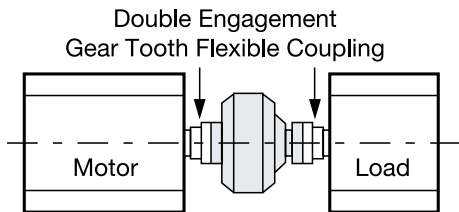

The Model HCM Fluid Coupling is a complete unit with both input and output flanges. It is intended for installation between two halves of a double engagement gear tooth flexible coupling which is customer supplied.

Size	Manufacturer	Model	Maximum Bore	Diameter of Shrouded Bolt Circle
7.0	TB Woods	1F	1.75	3.75
	Waldron	1W	1.63	3.750
	Poole	MXB 1	1.63	3.750
9.4 and 12.4	TB Woods	1.5F	2.25	4.812
	Amerigear	201.5	2.38	4.812
	Waldron	1.5 W	2.19	4.812
	Poole	MXB 1.5	2.19	4.812

Note: Gear couplings must be with Shrouded Bolts!

# Mesur-Fil® Fluid Couplings

## Model HCM (Flexible Gear Couplings with Shrouded Bolts)

Sizes 15 – 34

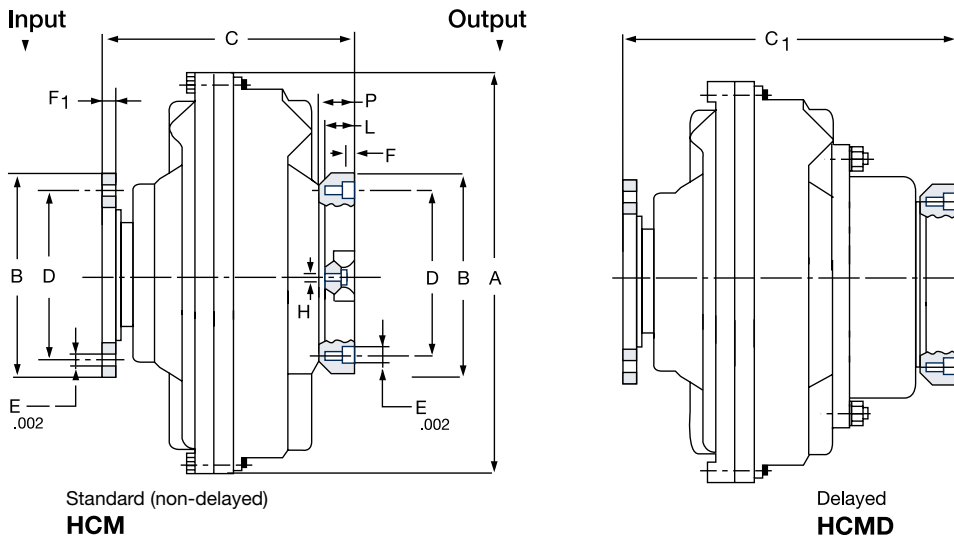

### Assembly Numbers

Size	Standard (Non-Delay)	Delay Chamber
15	6-615-003-002-0000	6-615-003-004-1000
17	6-617-003-002-0000	6-617-003-002-1000
19	6-619-003-002-0000	6-619-003-002-1000
21	6-621-003-002-0000	6-621-003-002-1000
24	6-624-003-002-0000	6-624-003-002-1000
27	6-627-003-001-0000	6-627-003-001-1000
29	6-629-003-001-0000	6-629-003-001-1000
34	6-634-003-001-0000	6-634-003-001-1000

Size	E										Wt. lb. Less Oil	Oil U.S. gal. Max.	WR <sup>2</sup> lb.ft. <sup>2</sup>			Gear Coupling Size	
	A	B	D	Nr.	Dia.	F	F <sub>1</sub>	H	L	C			C <sub>1</sub>	Outer	Inner		Outer for HCMD
15	18.11	8.385	7.000	10	0.502	0.354	0.394	1/2-20	0.945	9.84	12.95	104 ▲ 112	2.02 ▲ 2.27	13.5	4.5	▲ 14.6	2-1/2
17	20.47	8.385	7.000	10	0.502	0.374	0.394	1/2-20	1.000	9.84	13.079	146 ▲ 158	3.09 ▲ 3.48	22.5	8.6	▲ 25.0	2-1/2
19	22.24	8.385	7.000	10	0.502	0.374	0.394	1/2-20	1.000	9.84	13.079	165 ▲ 178	3.75 ▲ 4.22	33	14.5	▲ 35.1	2-1/2
21	24.41	8.385	7.000	10	0.502	0.374	0.394	1/2-20	1.22	12.59	16.38	240 ▲ 262	5.02 ▲ 6.07	51	23	▲ 57.2	2-1/2
24	27.95	8.385	7.000	10	0.502	0.374	0.394	1/2-20	1.22	12.59	16.38	285 ▲ 307	7.50 ▲ 8.24	96	46	▲ 102.2	2-1/2
27	30.71	11.020	9.500	8	0.750	0.866	1.220	3/4-10	2.008	16.06	20.71	454 ▲ 505	11.09 ▲ 13.21	145	48	▲ 160.0	3 1/2*
29	33.86	11.020	9.500	8	0.750	0.866	1.220	3/4-10	2.008	17.20	21.85	562 ▲ 613	14.53 ▲ 16.64	220.5	66.4	▲ 235.4	3 1/2*
34	39.37	12.159	11.00	8	0.750	0.866	1.102	3/4-10	2.283	24.96	28.90	960 ▲ 978	21.80 ▲ 24.5	650	28.5	▲ 668.5	4*

▲ HCMD \*Exposed Bolts

# Mesur-Fil® Fluid Couplings

## Model HSD (Parallel Shaft Applications)

Sizes 7.0 – 12.4

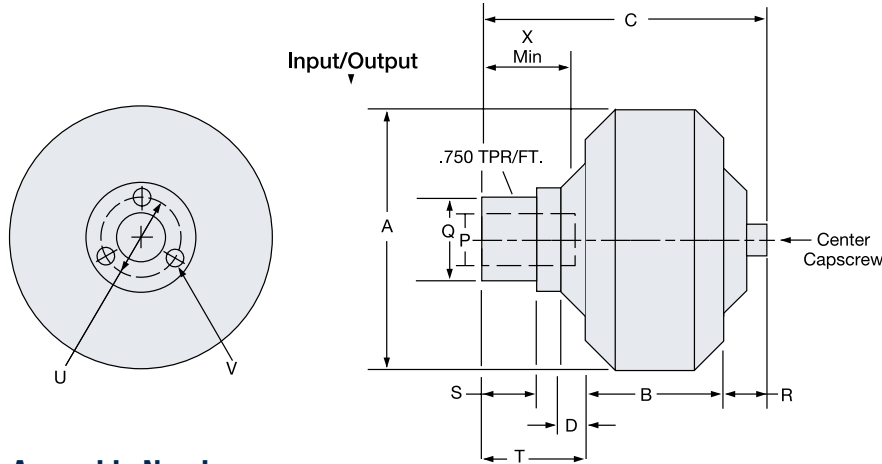

### P = Standard Input Sizes

Size	Bore	Key
7.0	7/8	3/16
	1	1/4
	1 1/8	1/4
	1 3/8	5/16

Size	Bore	Key
9.4	1 1/8	1/4
	1 3/8	5/16
	1 5/8	3/8

Size	Bore	Key
12.4	1 5/8	3/8
	1 7/8	1/2
	2 1/8	1/2
	2 3/8	5/8

### Assembly Numbers

Size	Bore (in.)	Assembly Number
7.0	7/8	6-607-005-001-0000
	1	6-607-005-002-0000
	1-1/8	6-607-005-003-0000
	1-3/8	6-607-005-004-0000
9.4	1-1/8	6-609-005-001-0000
	1-3/8	6-609-005-002-0000
	1-5/8	6-609-005-003-0000
12.4	1-5/8	6-612-005-001-0000
	1-7/8	6-612-005-002-0000
	2-1/8	6-612-005-003-0000
	2-3/8	6-612-005-004-0000
3/8" NPT Fusible Plug		4-619-068-000-0

### Dimensions: inches

Size	A	B	C	D	Q	R	S	T	U	V	X	Q.D. Hub Size	Dry Wt.
7	7.81	3.67	7.05	.56	2.149	.84	1.15	2.54	2.687	1/2-20	2.00	SD	12.75
9.4	10.25	4.70	9.35	.77	2.736	1.12	1.45	3.53	3.313	5/16-18	2.50	SK	37.75
12.4	13.50	5.98	12.12	.82	3.736	1.24	1.87	4.90	5.000	1/2-13	3.00	E	68.00

Do not use Eaton QD sheaves.  
Bolt pattern is not the same.

### Vertical Mounting For HSD

When mounting the 7.0, 9.4 or 12.4 HSD on a vertical shaft, the motor and collet should be mounted above the sheave and fluid coupling. This position insures even the smallest oil fill will react with the motor.

Furthermore, order the unit with the standard and optional fill plugs on both sides of the unit. This allows for the addition and maintenance of the oil level within the fluid coupling.

### Important note:

Size	Center Capscrew Torque
7.0	38-42 lb.ft.
9.4 and 12.4	177-195 lb.ft.

HSD	Maximum Speed
7.0	3,600 RPM
9.4	2,600 RPM
12.4	1,800 RPM

Model Size	Casting on Housing
7.0	216262 A
	216405 A
9.4	216438 A
	216439 A
12.4	219463 A
	219464 A

# Mesur-Fil® Fluid Couplings

## Model HSD

### Sizes 15-24

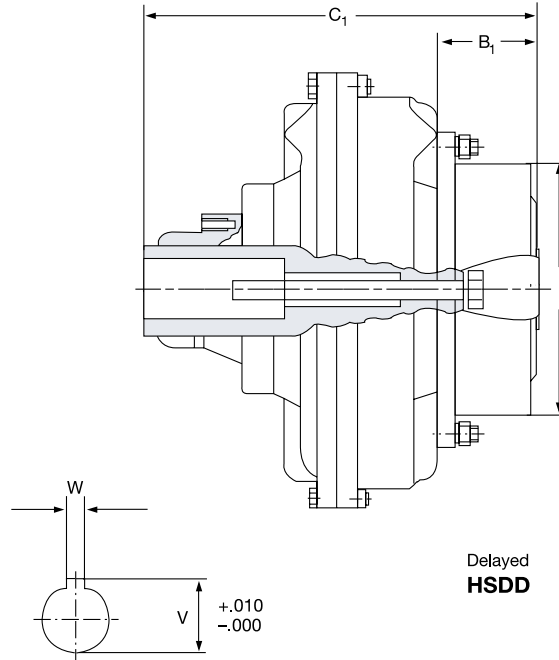
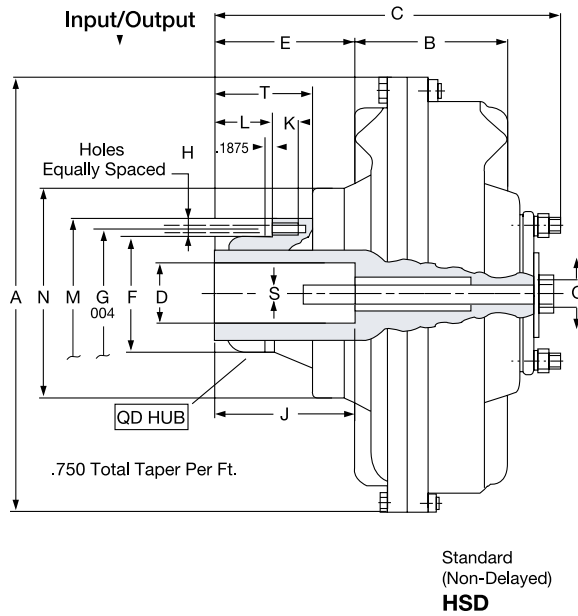

### Assembly Numbers

Size	Bore (in.)	Standard (Non-Delay)	Delay Chamber
15	2-7/8	6-615-005-001-0000	6-615-005-001-1000
	2-3/8	6-615-005-002-0000	6-615-005-002-1000
17	2-7/8	6-617-005-001-0000	6-617-005-001-1000
	3-3/8	6-617-005-002-0000	6-617-005-002-1000
19	3-3/8	6-619-005-001-0000	6-619-005-001-1000
	2-7/8	6-619-005-002-0000	6-619-005-002-1000
21	3-7/8	6-621-005-001-0000	6-621-005-001-1000
	3-3/8	6-621-005-002-0000	6-621-005-002-1000
24	3-3/8	6-624-005-001-0000	6-624-005-001-1000
	3-7/8	6-624-005-002-0000	6-624-005-002-1000

### Tolerance:

Dim D	up to 2 inch	+0.01
		-.000
Dim W	from 2 to 4 inch	+0.015
		-.000
Dim W	up to .500 inch	+0.002
		-.000
Dim W	from .625 to 1 inch	+0.003
		-.000

### Dimensions: inches

Size	D	J	W	V	A	B	B <sub>1</sub>	C Max.	C <sub>1</sub>	E	F	G	H Nr. Dia.	I	K	L	M	N	Q	T	S	QD Hub Size	Wt. Less Oil	Oil US Gal Max.
15	2.875	7.000	.750	2.992	18.110	5.945	3.425	15.118	17.244	7.677	4.4375	5.625	3	10.039	1.181	3.397	6.663	8.032	7/8 9 UNC	6.362	3/4 10 UNC	F	107	2.02
15	2.375	5.625	.625	2.651	18.110	5.945	3.425	15.118	17.244	7.677	4.4375	5.625	3	10.039	1.181	3.397	6.663	8.032		6.362			▲ 115.8	▲ 2.27
17	3.375	8.250	.875	3.635	20.472	6.693	3.779	17.913	20.315	9.654	5.1484	6.250	3	12.992	1.378	4.331	7.25	8.976		8.449		J	156	3.09
17	2.875	7.000	.750	3.205	20.472	6.693	3.779	17.913	20.315	9.654	5.1484	6.250	3	12.992	1.378	4.331	7.25	8.976		8.449			▲ 169.2	▲ 3.48
19	3.375	8.250	.875	3.635	22.244	7.480	3.779	17.913	20.315	8.858	5.1484	6.250	3	12.992	1.378	4.331	7.25	8.976	1-1/4 7 UNC	8.449	7/8 9 UNC	J	174	3.75
19	2.875	7.000	.750	3.205	22.244	7.480	3.779	17.913	20.315	8.858	5.1484	6.250	3	12.992	1.378	4.331	7.25	8.976		8.449			▲ 187.2	▲ 4.22
21	3.875	8.500	1.000	4.314	24.409	8.071	4.330	21.456	24.408	11.811	6.500	7.875	4	15.748	1.575	7.085	9.00	9.842		10.236		M	270	5.02
21	3.375	8.250	.875	3.760	24.409	8.071	4.330	19.882	22.833	10.236	6.500	7.875	4	15.748	1.575	5.511	9.00	9.842		8.661			▲ 292	▲ 6.08
24	3.875	8.500	1.000	4.314	27.953	9.015	4.528	21.456	24.408	10.866	6.500	7.875	4	15.748	1.575	7.085	9.00	10.394		11.024		M	307	7.50
24	3.375	8.250	.875	3.760	27.953	9.015	4.528	19.882	22.835	9.291	6.500	7.875	4	15.748	1.575	5.512	9.00	10.394		9.449		M	▲ 329	▲ 8.24

▲ HSDD

● Max. Bore

■ With Reduced Depth Keyway