

Warner Electric

Boston Gear

TB Wood's

Formsprag Clutch

Wichita Clutch

Marland Clutch

Industrial Clutch

Bauer Gear Motor

Nuttall Gear

Warner Linear

Delroyd Worm Gear

Stieber Clutch

Svendborg Brakes

Ameridrives Couplings

Inertia Dynamics

Matrix International

Huco Dynatork

Bibby Turboflex

Twiflex Limited

Kilian Manufacturing

Lamiflex Couplings

Ameridrives Power  
Transmission

# A New Wrinkle to Diaphragm Couplings

Presented at the  
**Design Engineering  
Technical Conference**  
September, 1977

---



An Altra Industrial Motion Company

# A New Wrinkle to Diaphragm Couplings

Jon R. Mancuso, Manager of Engineering  
Zurn Industries Inc., Mechanical Drives Division

## Abstract

The development of metallic disk flexible couplings started with the turn of the 20th Century and the automotive industry, and continues today with its applications for high speed turbo-machinery. The development and philosophy behind the design of the multiple convoluted diaphragm coupling will be presented. Specific areas discussed will be the advantages of the thin multiple parallel path diaphragm and the wrinkle (convolution) and how they function with respect to angular, offset and axial misalignment. Moments and forces of a multiple convoluted diaphragm will be compared to gear tooth, diaphragm and disk couplings. Other facts considered when using diaphragm couplings are axial resonance and heat generation due to windage. The information given in this paper can be helpful in selecting the proper coupling for your equipment

## Nomenclature

|           |   |   |
|-----------|---|---|
| $T$       | = | Thickness of diaphragm                                      |
| $t$       | = | Thickness of single diaphragm in a multiple pack            |
| $N$       | = | Number of diaphragms  |
| $S_A$     | = | Axial stress at inside diameter (lb/in <sup>2</sup> )       |
| $W$       | = | Axial load (lb)   |
| $d$       | = | Axial motion (in)   |
| $K_a$     | = | Axial stiffness of a pack (lb/in)                           |
| $K_A$     | = | Axial stiffness of a coupling (lb/in)                       |
| $\tau$    | = | Shear stress at inside diameter (lb/in <sup>2</sup> )       |
| $S_c$     | = | Centrifugal stress at inside diameter (lb/in <sup>2</sup> ) |
| $S_t$     | = | Thermal stress at inside diameter (lb/in <sup>2</sup> )     |
| $S_F$     | = | Angular flexure stress (lb/in <sup>2</sup> )                |
| $S_o$     | = | Offset stress (lb/in <sup>2</sup> )                         |
| $\alpha$  | = | Misalignment (deg)  |
| $s$       | = | Distance removed from center of misalignment (in)           |
| $S$       | = | Steady state tensile (lb/in <sup>2</sup> )                  |
| $S_M$     | = | Combined mean stress (lb/in <sup>2</sup> )                  |
| $S_B$     | = | Total alternating stress (lb/in <sup>2</sup> )              |
| $N$       | = | Safety factor on endurance                                  |
| $S_{ult}$ | = | Material ultimate strength (lb/in <sup>2</sup> )            |
| $S_{end}$ | = | Endurance limit of material (lb/in <sup>2</sup> )           |
| $\mu$     | = | Coefficient of friction                                     |
| $W$       | = | Excitation frequency, cycle/min                             |
| $W_N$     | = | Natural frequency, cycle/min                                |
| $g$       | = | 386 in/sec <sup>2</sup>                                     |
| $S_{st}$  | = | Static deflection   |

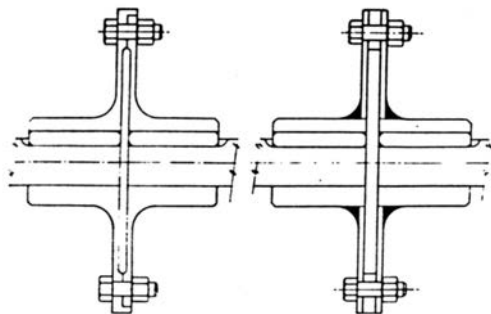

Fig. 1: Diaphragm coupling patented in 1886: (a) flange web machined thin to give flexibility, (b) thin sheets welded to hubs to provide even greater flexibility

## History Of Metallic Disk Flexible Couplings

The concept of a flexible metallic disk coupling started in 1886 (1)<sup>1</sup> with a simple modification to rigid type couplings, permitting the connected shaft to run somewhat smoother even though the connected parts were not in exact alignment. Fig. 1 is a sketch which shows the simplicity of this coupling. Fig. 1(a) shows a rigid coupling whose flange webs were machined thin to provide the flexibility needed to accommodate "some" misalignment. The inventor states that if greater flexibility is required, flanges could be made out of thin sheet metal and welded to hubs mounted on equipment shafts — Fig. 1(b).

There are two basic types of flexible metallic disk couplings. One is a "diaphragm," Fig. 2(a), which consists of one or more metallic disks which are attached at the outside diameter of a drive flange and transfers torque through the diaphragm to an inside diameter attachment. The other type is a "disk coupling," Fig. 2(b), which usually consists of several flexible metallic disks which are alternately attached with bolts to opposite flanges. Both types can be used singularly or in a pair separated by a spool piece. A single set of disk or diaphragms can handle only angular misalignment. It requires two sets of disk or diaphragms to accommodate for equipment shaft offset.

First recorded use of disk and diaphragm couplings date back to 1922. The first recorded usage of a diaphragm coupling was on a Jungstrom locomotive (2). Also around this time, records indicate that a large disk coupling was applied to a rolling mill at Brier Hill Steel Company in Youngstown, Ohio (3).

The advent of the automobile produced the metallic disk flexible coupling. This can be seen in patent after patent (4, 5) which states that the invention's intent was to replace the universal joint. The useful applications of metallic disk couplings through the 1940's were limited to low torque, low speed applications where only limited amounts of misalignment were required. The appearance of the small gas turbine in the late 1940's produced the thin contoured diaphragm coupling. This coupling saw its usage in aircraft applications. The progress and acceptance of this coupling in the industrial market has been greatly hampered by the inherent inability to accommodate high misalignment and larger amounts of axial movement.

For many years, precision gear couplings have been used on industrial high-speed, steam turbines, gas turbines, compressors, pumps and marine propulsion systems. But as horsepower, speed, and operating temperature increased, many problems with gear couplings developed. The high-speed turbomachinery has produced the need for the wrinkle in the multiple diaphragm coupling.

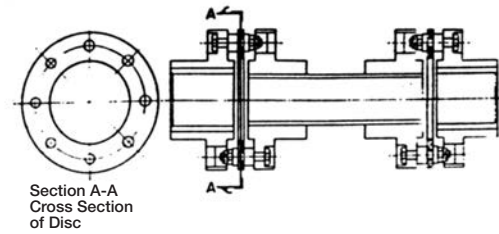

Fig. 2(a): Outline sketch of a typical disk type coupling

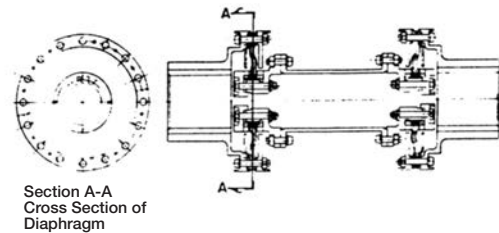

Fig. 2(b): Outline sketch of a diaphragm coupling

## Coupling Requirements and Needs

Way back in 1912, Dion and Bouton (6) explained in their patent the main reason for the existence and continued interest in diaphragm couplings was that existing universal joints were hard to maintain and needed frequent lubrication. They go on to claim that their coupling could eliminate lubrication and maintenance. Elimination of lubrication and maintenance on couplings has been a designer's goal.

An article on flexible couplings by Serrell (7) in 1922 describes some of the basic requirements of a flexible coupling:

1. Safety
2. Provide for off-center and angular misalignment
3. Not impose excessive strains on connected shaft
4. Readily assembled and taken apart without movement of equipment
5. Various parts of coupling should be interchangeable
6. Years of operation without constant attention and lubrication.

These basic needs have never changed. However, as rotating equipment became more sophisticated and the operating requirements of couplings have increased, manufacturers and users of high-speed turbomachinery have increased their list of requirements to include the following:



Fig. 3: Cutaway of a multiple convoluted diaphragm coupling

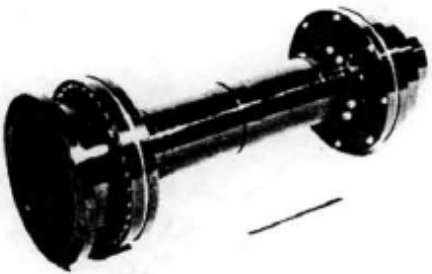

Fig. 4: Multiple convoluted diaphragm coupling built for a gas turbine pump drive. Coupling is designed to handle 27,000 hp @ 5200 rpm and accommodate 1/2-deg misalignment and  $\pm 3/8$ -in. axial travel

1. No lubrication
2. Handle higher torque without increase in coupling size
3. Accommodate greater misalignment
4. Accommodate greater axial motion
5. Suitable for high temperature operation
6. Not affected by exposure to corrosive atmospheres
7. Adaptable to all types of connections; splines, taper shafts, flanges, etc.
8. Produce low moments and forces
9. Produce predictable moments and forces
10. Easily balanced
11. Operate for years without maintenance or problems
12. Produce low vibratory inputs into equipment.

A coupling to meet all these requirements was thought to be only a dream, but the wrinkle has made it a reality.

#### Description Of A Multiple Convoluted Diaphragm Coupling

A cutaway of a multiple convoluted diaphragm is shown In Fig. 3. This coupling incorporates rigids that are bored to fit equipment with shafts or flanged adapters that can be used if the equipment has flanges. The rigid or adapter is bolted to the outside diameter of the flexing element which is called a diaphragm pack. The bolting is designed to provide sufficient clamp load to drive the outside diameter of diaphragm through friction for normal

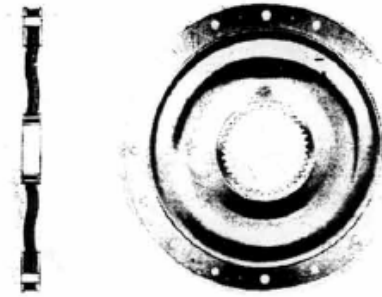

Fig. 5: The multiple convoluted diaphragm pack; the heart of the coupling

torques. Peak and overload torques are handled by the tight fitted bolts through bending and shear. Torque is transmitted from the outside diameter of the pack through the parallel paths of multiple diaphragms then to the inside diameter spline of the pack to the spline on the adapter and then to spacer, and onto the other half of the coupling which is connected to the driven piece of equipment. The clamp load at the inside diameter of the pack is applied by the clamp plate which bolts through the splined adapter. The force produced by the clamp plate at the inside diameter is sufficient to allow diaphragms and fillers to equally share the load and thereby allow the splined pack area to act as a unit. This arrangement allows for replacement of a diaphragm pack that has been damaged. Fig. 4 is a picture of a multiple convoluted diaphragm coupling used on a gas turbine pump drive. This coupling has a rigid on one end and a flanged adapter on the other end.

#### What Is A Multiple Convoluted Diaphragm Pack

The heart of a multiple convoluted diaphragm coupling is the stainless-steel diaphragm pack (Fig. 5). The pack consists of several thin convoluted diaphragms, separated by inside diameter fillers and segmented outside diameter fillers. These are riveted or welded together using thick end plates to give rigidity to the pack. It is the convolution (wrinkle) and the unrolling action of the convolution that results in the large axial capacity with low stresses. Disk, straight and contour diaphragms accommodate for axial motion by pure deformation of material. In fact, once axial motion in a disk, straight or contour diaphragm exceeds approximately half of material thickness, stiffness and stresses become non-linear and increase exponential. Therefore, predicting the axial force upon rotating equipment is very difficult for couplings that have non-linear stiffness which also creates a further problem in predicting the axial resonant frequency. Fig. 6 is a graph of force versus axial motion of disk, contour diaphragm, and convoluted diaphragm couplings of comparable size.

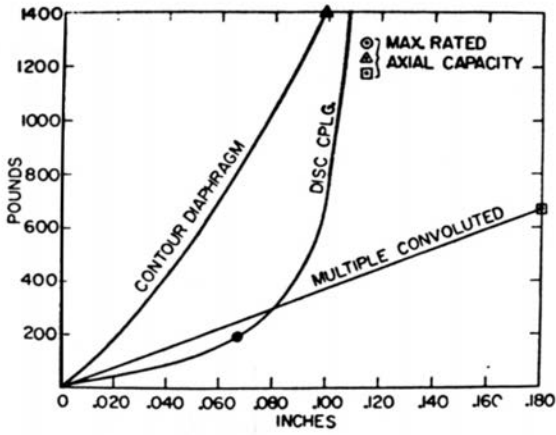

Fig. 6: Stiffness comparison showing nonlinearity in a contoured diaphragm and disk coupling as compared to linearity in a multiple convoluted diaphragm

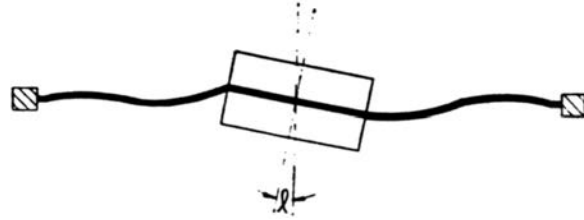

Fig. 8: Angular flexure of a single diaphragm

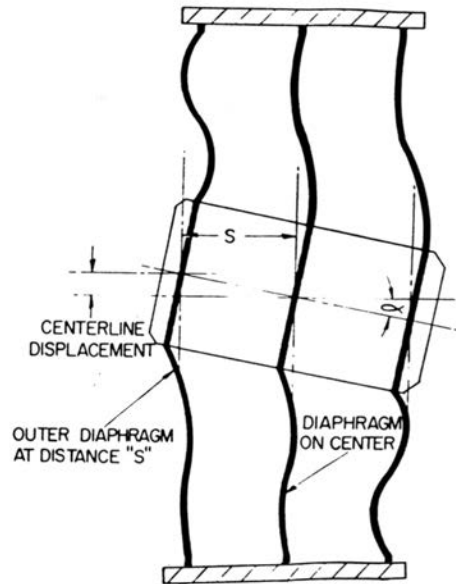

Fig. 9: Movement and deflection in diaphragms due to offset misalignment "s"

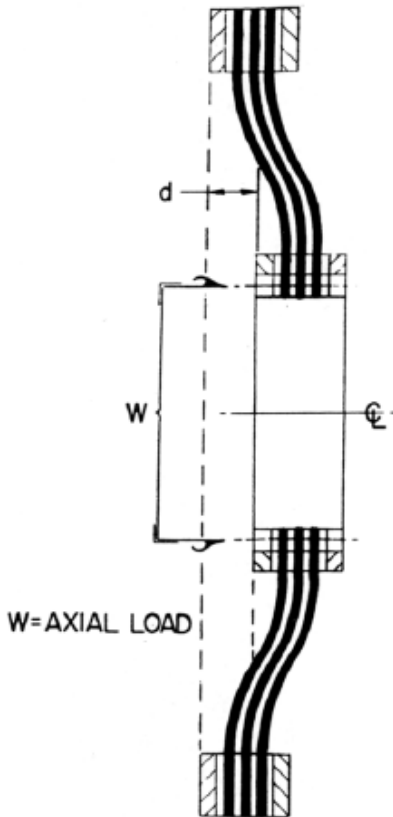

Fig. 7: Axial force produces deflection "d" and causes convolution to unroll

It is the thin convoluted diaphragms in parallel that give couplings the greatest axial and angular capacity. Stresses, moments, and forces of a diaphragm increase with the third power of the thickness ( $T^3$ ). Hence, the use of several thinner diaphragms produce substantially lower values ( $Nt^3$ ), where  $Nt$  is equal to  $T$ .

### Diaphragm Stresses

In order to understand diaphragm stresses. It is important to understand how the diaphragm reacts to the various types of misalignment. Figs. 7, 8, and 9 are exaggerated in order to more clearly demonstrate the diaphragm reaction to various forces and motions. It is important to also realize that a diaphragm on the centerline of the diaphragm pack reacts differently than a diaphragm offset from the centerline when angular misalignment is imposed on the entire pack.

Some of the stresses resulting from the diaphragm deflection shown are more or less continuous during the entire period of operation, and these are termed "steady state." On the other hand, some of the stresses not only vary,

but go through complete reversals during each revolution. These are termed "alternating."

### Steady-State Stress

The steady-state stresses are considered to be the stresses which result from: axial displacement of the diaphragm (Fig. 7), centrifugal effects, thermal gradient effects, and torque transmission.

Axial stress ( $S_A$ ) is determined by the amount of axial deflection imposed on the diaphragm.  $W$  is axial force,  $d$  is distance moved. The stiffness of pack is equal to:

$$K_a = W/d \text{ lb/in.} \quad (1)$$

The stiffness of a coupling is equal to:

$$K_A = W/2d \text{ lb/in.} \quad (2)$$

Shear stress ( $\tau$ ) occurs when torque is transmitted through the diaphragm pack and is dependent upon the size, number, and thickness of the diaphragms. Shear stress ( $\tau$ ) is highest at inside diameter of the diaphragm.

Centrifugal stress ( $S_C$ ) always results when the coupling is rotated, and this rotational effect on the diaphragm must be combined with the other steady-state stresses.

Thermal gradient stress ( $S_t$ ) applies only where there is a temperature differential across the surface of the diaphragms and/or where there is a coefficient of expansion difference. If this case exists, the combined thermal stress must be calculated.

### Alternating Stress

Two cases are considered which contribute to the total alternating stress: angular flexure stress (Fig. 8) and stresses due to offset deflection (Fig. 9).

Flexure stress ( $S_f$ ) is the result of the angular misalignment of the coupling. ( $\alpha$ ) is misalignment angle in degrees. Offset stress ( $S_o$ ) is caused by angular deflection of the inside diameter of the diaphragm with respect to the outside diameter. The diaphragm elements, which are spaced axially away from the centerline of flexure, experience a stress proportional to the distance that they are removed from the centerline. Fig. 9 shows a cross section of an exaggerated pack and how the outer diaphragms are compressed or stretched due to the distance(s) removed from the center of misalignment.

### Combined Diaphragm Stress

All the stresses presented in the foregoing are calculated at the inside diameter of the diaphragm and for the furthest diaphragm from the centerline which are then combined in the following manner to give the highest stress

point in the diaphragm pack. Steady-state axial stress, thermal stress, and centrifugal stress are additive.

$$S = S_A + S_c + S_t \quad (3)$$

These are then combined with the shear stress to determine the total mean stress:

$$S_M = (S/2) + \sqrt{\left(\frac{S}{2}\right)^2 + \tau^2} \quad (4)$$

Total alternating stress is conservatively determined by the simple summation of the offset and flexure stresses:

$$S_B = S_o + S_f \quad (5)$$

Finally, the mean stress and the alternating stress resulting from bending of the diaphragm can be plotted on a modified Goodman Line for various misalignments and total coupling axial displacements. Using a typical Goodman equation, the value of the design factor can be calculated. The results are shown in Fig. 10.

$$\frac{1}{N} = \frac{S_M}{S_{ult}} + \frac{S_B}{S_{end}} \quad (6)$$

### Design Variables

With the foregoing design parameters thus set, it has been found that angular misalignment capacity and axial displacement capacity bear a definite relationship to one another, and a decrease in one permits a corresponding increase in the other, approximately according to the relationship shown in Fig. 11.

Where more angular misalignment is required or a larger axial movement in shaft spacing must be accommodated for, a coupling with a special inner-to-outer diameter relationship can be used. It is also possible to vary the number of diaphragm elements per diaphragm pack in order to suit special cases of torque-stiffness-misalignment combinations.

### Safety Feature

The multiplicity of diaphragms provides an additional safety feature. Since the stresses in each diaphragm in a pack are not equal due to the addition of the offset stress, if a failure does occur it will occur in the outer diaphragm. Since diaphragms are separated, one failed diaphragm will not necessitate the next diaphragm to fail. The stress component due to torque is less than the offset stress. The next diaphragm will actually have a lower combined

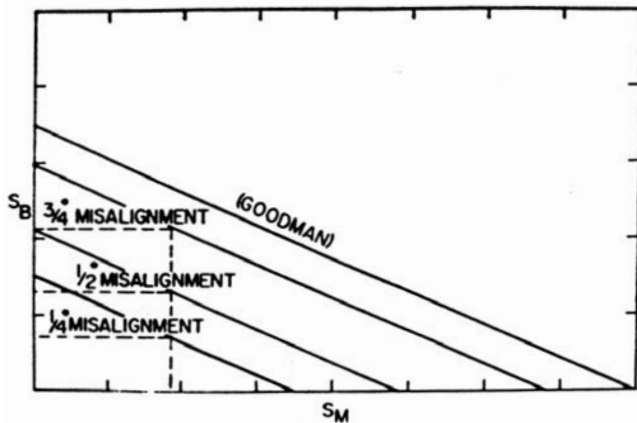

Fig. 10: Typical Goodman diagram plot

stress than did the failed diaphragm. This decreasing effect continues until approximately 50 percent of the diaphragms in the pack have failed. Then the torque component of stress becomes larger. When 75 percent of the diaphragms have failed, a shear failure at the inside diameter of the remaining diaphragms is likely to occur. Therefore, a failure due to over misalignment would be gradual and as the failed diaphragm continues to operate, cracks develop into broken pieces which would be trapped in the rigid or the guard. This will cause an unbalance which could be picked up on vibration monitoring equipment and give warning to prevent a total diaphragm failure and possible damage to the equipment. A total failure could also be prevented by inspection of the coupling at normal maintenance periods for cracks or distress areas in the outer diaphragm of the pack.

### Moments and Forces

A major advantage in the use of the thin convoluted lamination is that undesirable moments and forces transmitted to the bearings of the connected equipment are decreased and are predictable. In both the moment reaction and axial force equation for disk and diaphragm couplings, the magnitude of the values increases with the third power of the thickness.

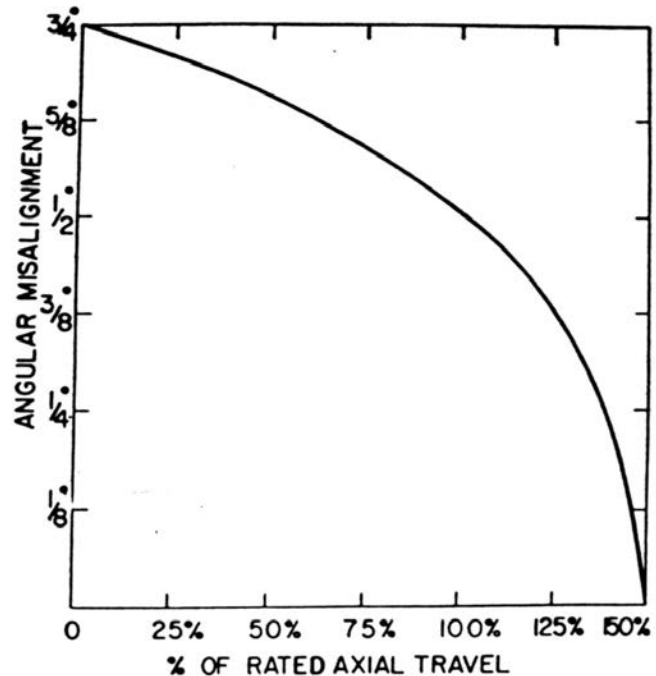

Fig. 11: Angular misalignment versus axial travel capacity

The convolution provides for a linear stiffness over a larger range of axial travel than does a straight disk or diaphragm. Diaphragm and disk couplings have a distinct advantage over gear couplings in axial force and misalignment moment predictability.

The most difficult item of a gear coupling to predict is the coefficient of friction which determines the moment and force imposed upon connected equipment. Values of coefficient of friction have been measured and range from 0.01 to 0.35 (8). This makes it very difficult to select a value and use it to calculate forces to use in designing bearings for rotating equipment. The most widely used value of coefficient of friction is 0.15 which will be used in the following comparison. As a comparison we will pick a typical application to compare gear, disk, contour diaphragm and multiple convoluted diaphragm couplings.

### Application Data

- Driver steam turbine
- Driven — single-stage reactor feed pump
- Rating — 16,600 hp @ 5200 rpm  
201,100 in.-lb
- Angular misalignment - 1/4 deg
- Axial displacement — ±0.100
- Shaft size — 6 in.

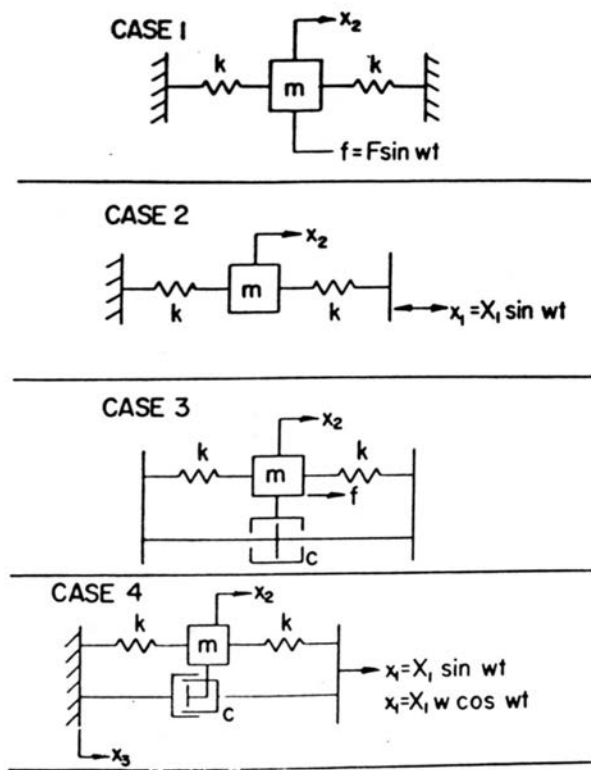

Fig. 12: Mass-elastic diagrams that simulate diaphragm coupling axial response

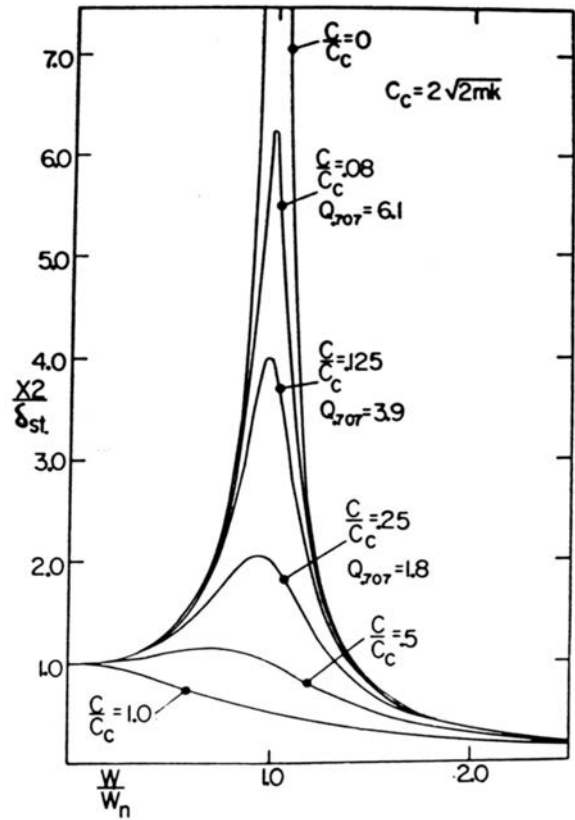

Fig. 13: Axial response plot for Case 3

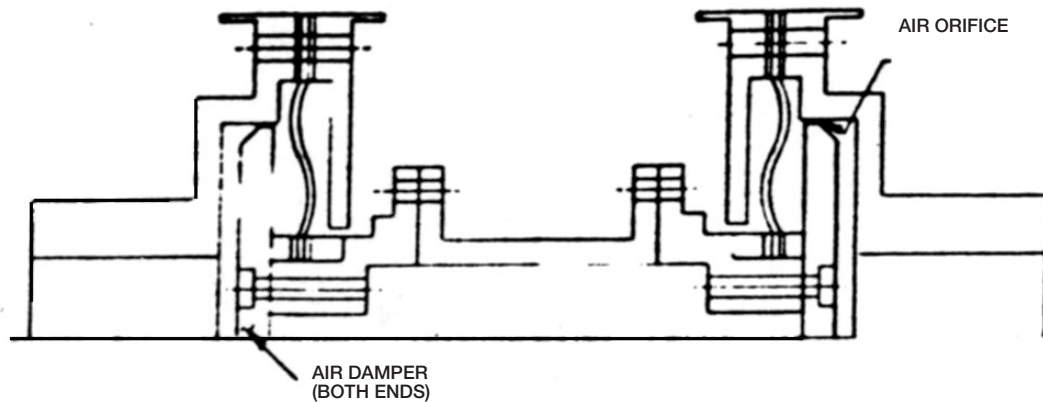

Fig. 14: Multiple convoluted diaphragm coupling with an air orifice damper



Table 1 Comparison of Moment and Forces

|                                   | Gear Coupling | Disk    | Contoured Diaphragm | Multiple Convolved Diaphragm |
|-----------------------------------|---------------|---------|---------------------|------------------------------|
| Outside diameter (in.)            | 12.75         | 14.8    | 14.5                | 12.9                         |
| Maximum misalignment (deg)        | 1/4           | 1/4     | 1/4                 | 1/2                          |
| Maximum axial travel (in.)        | *             | ± 0.092 | ± 0.120             | ± 0.210                      |
| Bending moment @ 1/4 deg (in.-lb) | 13,500        | 1,540   | 3,175               | 1,460                        |
| Thrust load @ 0.050 in. (lb)      | 6,700         | 310     | 800                 | 310                          |
| Thrust load @ 0.100 in. (lb)      | 6,700         | 773     | 1,750               | 620                          |

\* Axial capacity of gear coupling is unlimited

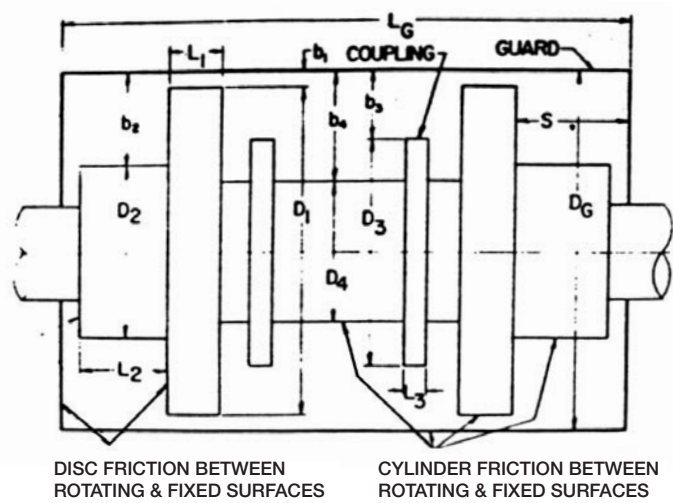

Fig. 15: Outline sketch of a diaphragm coupling in a coupling guard

## Axial Resonance

Extensive testing (9) has been done to verify calculations which predict resonance and also how it is controlled. Fig. 12 shows four possible cases that could represent motion and vibration response of a diaphragm coupling.

- Case 1 — Center body forced, no damping
- Case 2 — Ends moved, no damping
- Case 3 — Center body forced with damping
- Case 4 — Ends moved, with damping.

Case 1 and 2 would not normally occur unless coupling operates in a vacuum. A response plot for Case 3 is given in Fig. 13. For this plot (C) is the viscous damping (lb/in./sec). (W) is the driving frequency. ( $W_N$ ) is the natural frequency.

$$W_N = \frac{60}{2\pi} \sqrt{\frac{2K_a g}{W}} \quad (\text{cpm}) \quad (7)$$

$$W_N = 375 \sqrt{\frac{K_A}{W}}$$

( $S_{st}$ ) which equals the static deflection, equals the driving force divided by  $2K$ . ( $K_a$ ) is the stiffness of a diaphragm pack. ( $K_A$ ) is the stiffness of a coupling. The plot of  $(2X/S_{st})$  is the response, and the peak of the curve is the value of Q and is defined as the actual amplification factor.

The important fact from this analysis is that the Q for Case 4 is one-half of Q for Case 3. Therefore, if Q for a coupling is found to be 24 and if the equipment shaft is being moved back and forth at a frequency equal to resonance at an amplitude of 2 mils peak to peak, then the center shaft will vibrate at 24 mils peak to peak.

Values for Q of a coupling can be made to be 20 or lower with the use of air orifice damping. Fig. 14 is a schematic of a coupling showing an air damper incorporated into the coupling. It is best to design a coupling having an axial resonance  $\pm 20$  percent away from operating speed, but if it is required that a coupling must run at its resonant frequency, the resulting vibratory axial motion must be added to dynamic stresses, and, therefore, some reduction in operational angular and axial capacity would be required.

## Heat Generation

A diaphragm coupling can generate heat due to flexing of material due to misalignment. Also, heat can be generated by windage and surface friction. If heat generated by windage is overlooked, temperatures may rise to an extreme, requiring cooling provision such as a continuous supply of cooling oil. This, in effect, contradicts the design premise of a non-lubricated diaphragm coupling. Multiple convoluted diaphragm couplings flex less material and, therefore, generate less heat, and since there is no contact between diaphragms, there are no friction losses to generate heat. The packs are separated and vented at the outside diameter with segmented fillers which help dissipate any heat generated by flexing of diaphragms.

Multiple convoluted diaphragms allow a coupling to be smaller than most diaphragm or disk couplings (Table 1), and thereby provide more room between outside diameter of the coupling ( $D_1$ ) and the coupling guard ( $D_G$ ). With the correct design of coupling guards, the heat generated can be held to a minimum to prevent problems. Heat is generated by air frictional resistance within the enclosure. See Fig. 15 which is an outline sketch showing diameters, areas, lengths, and gaps considered when calculating for heat generation.

The disk effect is proportional to  $(\text{rpm})^3$ ,  $(\text{diameter})^5$  and accounts for frictional losses on both ends of the rigids against the guards. The cylinder effect is proportional to  $(\text{rpm})^2$ ,  $(\text{diameter})^4$ , length, and a complex function of the gap between the guard and the coupling (10).

## Conclusions

The multiple convoluted diaphragm coupling is the answer to the rotating equipment designer's goal. The multiple convoluted coupling provides the reliability needed today in turbo-machinery. Non-lubricated couplings will and are being used more and more today. It is important that the users of couplings understand the various types, the advantages, and disadvantages of available couplings and what should be considered before selecting a coupling for their equipment.

## Acknowledgements

The Author wishes to acknowledge and extend gratitude to Andrew M. Sima for graphs and sketch work, Kathleen A. Feidler for typing, proofreading, and editing, and Zurn Industries, Inc., Mechanical Drives Division, for their support in this paper.

## References

- 1 Roots, F. M.. "Shaft Coupling," United States Patent No. 349:365, Sept. 1886.
- 2 Rothfuss, N. B., "Contoured Diaphragm-Type Flexible Disc Coupling," Penn State University Engineering Proceedings No. P-41, Jan. 1963. P. 159.
- 3 Gooding, F. E., "Types and Kinds of Flexible Couplings," Industrial Engineer, Vol. 81, No. 11, 1923. p. 532.
- 4 Gill, E. R., "Universal Joint for Power Transmission," United States Patent No. 1445,272, Feb. 1923.
- 5 Jencick, S., "Flexible Shaft and Universal Coupling Theory," United States Patent No. 1283,787. Nov. 1918.
- 6 Dion and Bouton, "Flexible Coupling," French Patent No. 446,977. Dec. 1912.
- 7 Serrel, J. J., "Flexible Couplings," Machinery, Oct. 1922. pp. 91-93.
- 8 Mancuso, J. R.. "Moments and Forces Imposed on Power Transmission Systems due to Misalignment of a Crowned Tooth Coupling," Master Paper, Penn State University, June 1971.
- 9 "Investigative Analysis and Testing of Vibratory Response Characteristics of the Ameriflex Type Coupling," Fern Engineering Company, Zurn Industries, Inc., Mechanical Drives Division, Report No. 76-E2, May 1975-
- 10 "Ameriflex Coupling Windage Loss and Guard Temperature Analysis," Fern Engineering Company, Zurn Industries, Inc., Mechanical Drives Division, Report No. 76-E9, Aug. 1976.
- 11 "Ameriflex Flexible Diaphragm Coupling," Zurn Industries, Inc., Mechanical Drives Division, Form No. 271-ADV, Sept. 1975.

## About Altra Industrial Motion

Altra Industrial Motion (NASDAQ:AIMC) is a leading multi-national designer, producer and marketer of a wide range of electromechanical power transmission products. The company brings together strong brands covering over 40 product lines with production facilities in nine countries.

Altra's leading brands include Boston Gear, Warner Electric, TB Wood's, Formsprag Clutch, Wichita Clutch, Industrial Clutch, Ameridrives Couplings, Kilian Manufacturing, Marland Clutch, Nuttall Gear, Bauer Gear Motor, Stieber Clutch, Svendborg Brakes, Twiflex Limited, Bibby Turboflex, Matrix International, Inertia Dynamics, Huco Dynatork, Lamiflex Couplings, Ameridrives Power Transmission, Delroyd Worm Gear and Warner Linear. For information on any of these technology leaders, visit [www.AltraMotion.com](http://www.AltraMotion.com) or call 815-389-3771.



*An Altra Industrial Motion Company*

### **US (Customer Service)**

814-480-5000

[www.ameridrivescouplings.com](http://www.ameridrivescouplings.com)

### **Asia Pacific**

For a list of our AP sales offices:

[www.AltraMotion.com/ContactUs](http://www.AltraMotion.com/ContactUs)